

# DipTrace

SCHEMATIC AND  
PCB DESIGN SOFTWARE

# Tutorial

10/26/2017

## Introduction

Welcome to DipTrace Tutorial. This PDF document is where you start with DipTrace PCB design software. It provides all the guides, step-by-step instructions, detailed descriptions of typical working principles, and all the insights and essentials to succeed as an electronic engineer in DipTrace. This tutorial will be a useful tool for both professionals and beginners in the engineering field.

In the Part I, II, and III we will create a simple schematic, PCB, and generate manufacturing files, then practice in creating new components and working with libraries in the Part IV, and, finally, practice in using more advanced features in the Part V.

For a quick answer, please refer to the corresponding Help document ("Help \ <DipTrace module> Help" from the main menu).

Created for DipTrace version 3.2 (October 26, 2017).

# Table of Contents

<b>Part I: Creating a simple schematic</b>	<b>5</b>
1 Schematic UI.....	6
Schematic main window .....	6
Custom keyboard hotkeys .....	7
2 Establishing schematic size and placing titles.....	8
3 Configuring libraries.....	11
4 Designing a schematic.....	12
5 Converting to a PCB.....	29
<b>Part II: Designing a PCB</b>	<b>30</b>
1 PCB Layout UI.....	30
2 Preparing to route.....	31
3 Autorouting.....	38
4 Working with layers.....	42
5 Working with vias.....	44
6 Net classes.....	47
7 Manual routing.....	50
8 Measuring trace length.....	56
9 Selecting objects by type/layer.....	58
10 Placing text and graphics.....	61
11 Copper pour.....	64
12 Locking objects.....	71
13 Design verification.....	73
14 Layout information.....	76
15 Panelizing.....	77
16 Printing.....	81
<b>Part III: Generating files for manufacturing</b>	<b>83</b>
1 DXF .....	83
2 Gerber RS-274X.....	84
3 Gerber X2.....	89
4 N/C Drill file (Excellon).....	90
5 ODB++.....	91
6 Order PCB.....	92
<b>Part IV: Creating Component Libraries</b>	<b>93</b>
1 Designing a pattern library.....	94
Customizing Pattern Editor .....	94
Create/Save library .....	95
Designing a resistor (pattern) .....	96
Attaching a 3D model .....	105
Designing BGA-144/13x13 .....	107

Real component design. SOIC-28 pattern .....	114
<b>2 Designing a component library.....</b>	<b>117</b>
Customizing Component Editor .....	117
Designing a resistor (component) .....	119
Designing a capacitor .....	122
Designing VCC and GND symbols .....	129
Designing a multi-part component .....	132
Using additional fields .....	140
Designing PIC18F24K20 .....	142
SPICE settings .....	149
Library verification .....	150
Placing parts .....	152

## **Part V: Other features and tools 156**

<b>1 Connecting.....</b>	<b>156</b>
Buses and bus connectors .....	156
Net ports .....	162
Connecting without wires .....	163
Connection Manager in Schematic and PCB Layout .....	167
<b>2 How to find components in the libraries.....</b>	<b>168</b>
<b>3 Reference Designators.....</b>	<b>170</b>
<b>4 Placement and autorouting.....</b>	<b>173</b>
<b>5 Layer stack.....</b>	<b>182</b>
<b>6 High-speed nets and differential signals.....</b>	<b>186</b>
Length matching .....	186
Signal delay .....	191
Create a differential pair .....	192
Differential pair routing/editing .....	195
Phase tuning a differential pair .....	201
Differential Pair Manager .....	205
Define paired pads .....	206
<b>7 Fanout.....</b>	<b>208</b>
<b>8 Renew layout by schematic.....</b>	<b>211</b>
<b>9 Back annotate .....</b>	<b>212</b>
<b>10 Hierarchical schematic.....</b>	<b>214</b>
<b>11 SPICE simulation.....</b>	<b>223</b>
<b>12 Saving/loading design rules.....</b>	<b>226</b>
<b>13 Electrical Rule Check.....</b>	<b>227</b>
<b>14 Checking net connectivity.....</b>	<b>229</b>
<b>15 Bill of Materials (BOM).....</b>	<b>232</b>
<b>16 Importing/exporting netlists.....</b>	<b>234</b>
<b>17 3D preview and export.....</b>	<b>236</b>
<b>18 DipTrace Links.....</b>	<b>240</b>



## Part I: Creating a simple schematic

In this part of the tutorial, you will learn how to create a simple schematic and generate a PCB (Printed Circuit Board) using the DipTrace software.

Let's start from the schematic. Open DipTrace Schematic, go to "Start \ All Programs \ DipTrace \ Schematic" in the Windows OS or use DipTrace Launcher on MacOS.

If this is the first time you launch DipTrace Schematic, the graphics mode and color scheme selection dialog box will pop up.

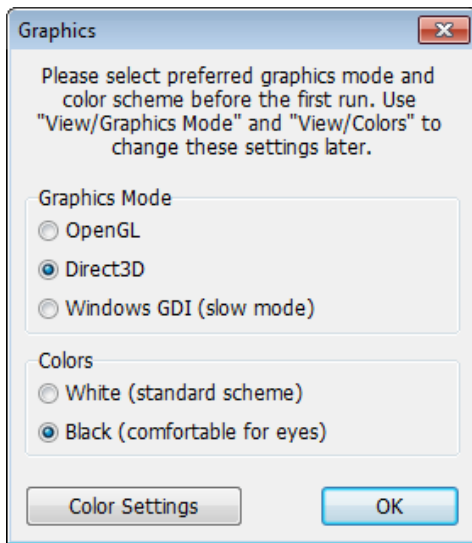

You can select the graphics mode that works better for you:

**1. Direct3D** is the fastest mode for typical Windows PC, we recommend you to use this mode if it works correctly on your system. Direct3D suits machines without high-end graphics system and OpenGL hardware. However, this mode depends on hardware/drivers/versions, therefore a small percentage of computers (usually with new/very buggy, or very outdated OS/drivers) can have issues (artifacts on the screen, etc.).

**2. OpenGL** usually works a bit slower than Direct3D, but it is more universal, suitable for different operating systems and less dependent on hardware/drivers.

OpenGL is the best choice for high-end engineering /

graphic stations with professional OpenGL equipment. However, you can try both modes on complex projects and choose the best for you.

**3. Windows GDI** is an alternate mode if both Direct3D and OpenGL failed to work properly with your graphics card. It is much slower but doesn't depend on drivers/hardware/OS. This mode is enough for comfortable work on small and medium-sized projects.

We will use a white background as more acceptable for printing this tutorial, but you can select the color scheme you want (classic black background is the most eye-friendly). Notice that you can change the color scheme or define colors any time in the "View \ Colors" main menu item.

Graphics dialog box will appear after the PCB Layout module has been launched for the first time. Component Editor and Pattern Editor use the color settings of Schematic Capture and PCB Layout respectively.

*Notice that relative sizes of program panels in the screenshots may differ from what you see on the screen due to resolution limitations applied in this PDF tutorial.*

Sometimes we will hide the Design Manager (which is on the right side of the screen) to add more design space, but if you have high-resolution screen you don't have to do this. Select "View \ Toolbars \ Design Manager" from the main menu to show/hide the Design Manager panel or press *Ctrl+2* default hotkeys.

*Some schematic and PCB examples presented in this tutorial are designed exclusively as a demonstration cases of the tools being used, they are not necessarily working prototypes.*

## 1.1 Schematic UI

### 1.1.1 Schematic main window

Schematic's main window includes the schematic design area, the main menu, toolbars, the Properties panel, Design Manager, the Place Component panel, and the status bar.

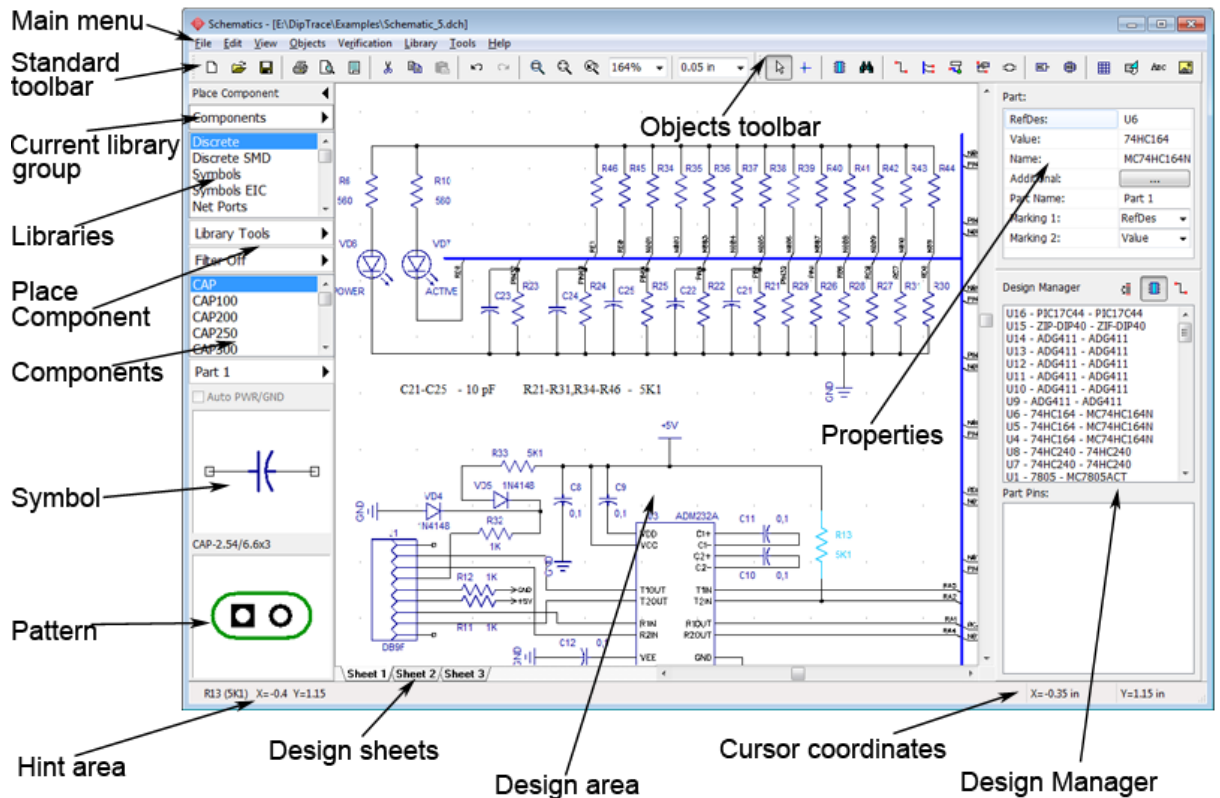

**Design area** – create and edit schematic objects (parts, wires, buses, shapes, tables, etc.). Access to all common functions of the program via the main menu.

**Standard toolbar** – tools to work with files, cut/copy/paste objects, print, preview and configure titles, change scale and grid size.



**Objects toolbar** – default mode, define origin, find and place components, create and edit wires and buses, place page connectors (Bus connectors), define differential pairs, place hierarchy connectors and blocks, place shapes, texts, and tables.

**Place Component panel** – all active libraries, user libraries or only components of the current project. Select library from the list, find component using the search filters and place it. Setup the panel, search filters, multi-part component placement tools, symbol and pattern previews.

**Properties panel** – displays the properties of an active tool or selected object/s.

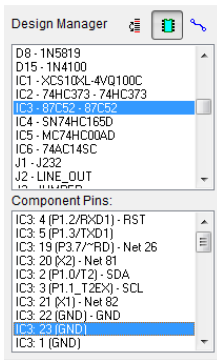
**Design Manager** – allows to quickly find any component or net in the circuit.



Press  button to see the list of components, or press  button to see the list of nets. Select component or net in the list, and all pins of selected component or net will appear in the list right below. Left-click in the list to highlight an object or double click it to pan the design area to selected object.

Press  to sort the list of components or nets alphabetically (useful when changing the RefDes array or adding new components).

**Status Bar** – left side shows the current hint and the right side shows the cursor coordinates.

See DipTrace Help for details ("Help \ Schematic Help" from the main menu).

Go to "View \ Toolbars \ <toolbar>" to hide / show any of the UI toolbars (or use *Ctrl+1* through 4 hotkeys).

## 1.1.2 Custom keyboard hotkeys

DipTrace features customizable hotkeys in all software modules. This makes switching to DipTrace especially convenient and fast since you can assign keyboard shortcuts that you've used to work with. Go to "Tools \ Hotkey Settings" from the main menu in Schematic, however, the same main menu item leads to the **Hotkey Settings** dialog boxes in any of the DipTrace modules: Schematic, PCB Layout, Component and Pattern Editors.

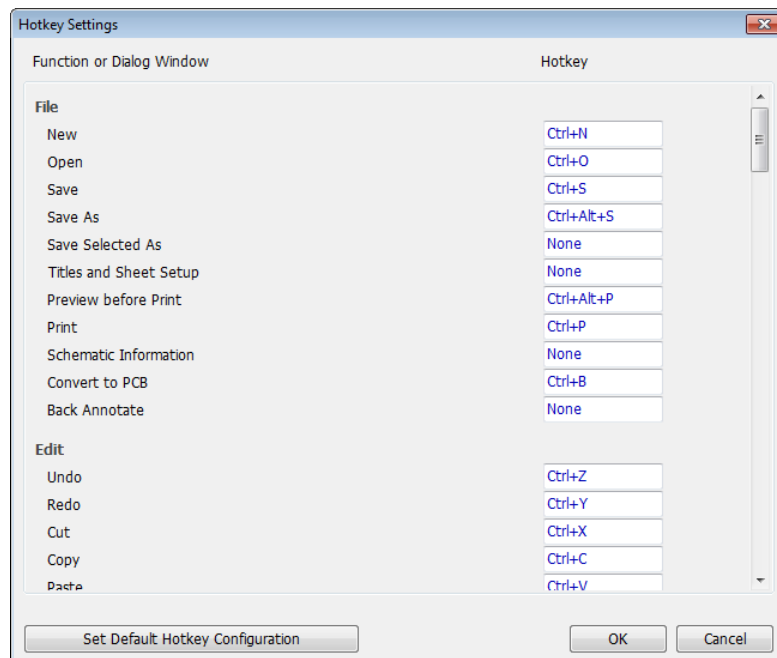

In our case, we have Schematic hotkeys, but described here can be applied to customizing shortcuts anywhere in DipTrace. In the **Hotkey Settings** dialog box, you can assign custom keyboard shortcuts to most DipTrace tools, program actions, and dialog boxes.

Let's assign another keyboard combination for creating a new file:

- Left-click in the corresponding field,
- Press key or key combination.

If the combination is already assigned to another tool you can either proceed with a new shortcut, or leave the old one.

**Notice that all hotkeys mentioned in all topics of this tutorial are default ones.**

Press **Set Default Hotkey Configuration** button to restore default values.

*Notice that certain keys and combinations are reserved by the system. Please refer to the **Hotkeys** topic in the Schematic Help document ("Help \ Schematic Help" from the main menu) for a complete list of reserved key combinations in DipTrace Schematic. Check out the corresponding topics in PCB Layout Help, Component Editor Help, and Pattern Editor Help to get more information about hotkeys in the respective programs.*

## 1.2 Establishing schematic size and placing titles

We start with establishing the size of schematic sheet and placing the drawing frame, go to "File \ Titles and Sheet Setup" from the main menu, and select **ANSI A** from the **Sheet Template** drop-down box. Then go to the bottom of the dialog and check **Display Titles** and **Display Sheet** items. Press **OK**.

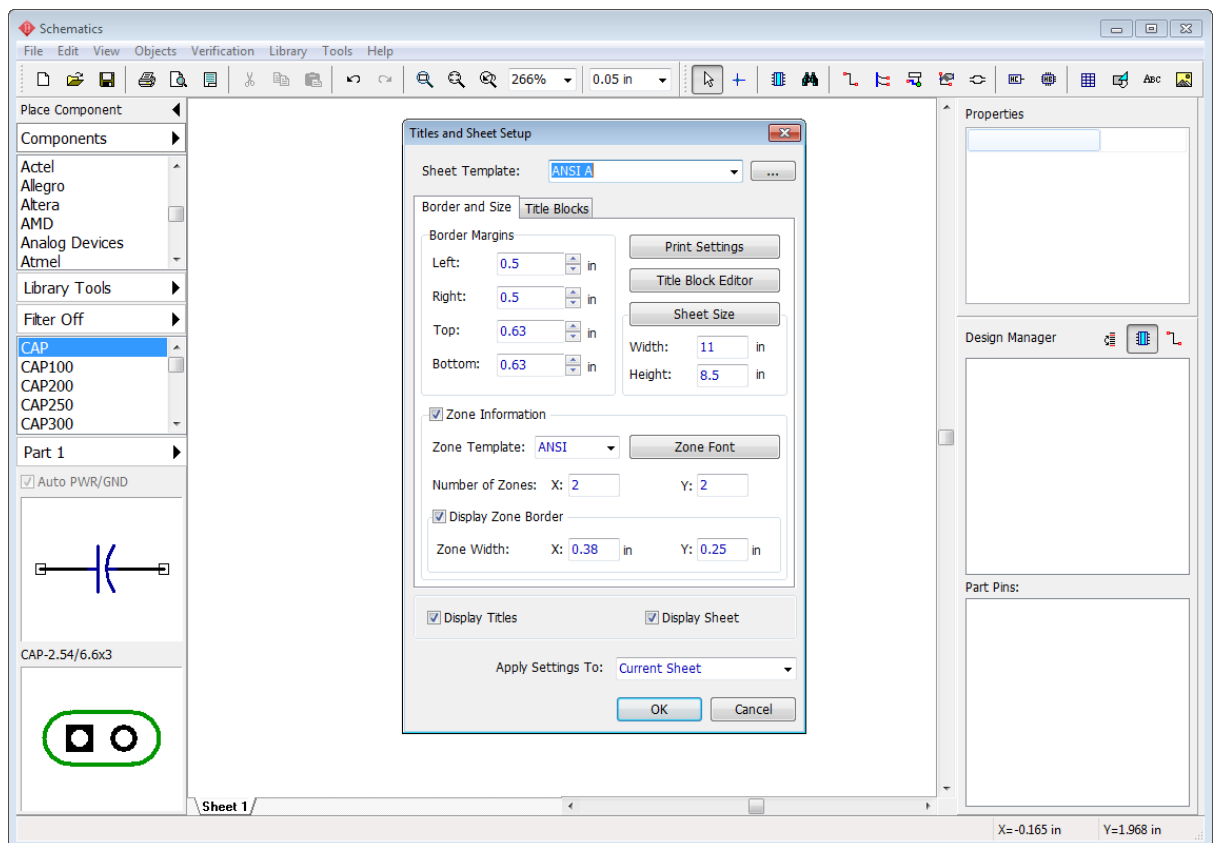

*Notice that you can show/hide titles and sheet on the design area by selecting "View \ Display Titles" and "View \ Display Sheet" from the main menu.*

Now press the **Minus Sign (-)** hotkey to zoom out until you can see the drawing frame. *Plus*

and *Minus signs* (+) (-) hotkeys, the mouse wheel, and the scale box on the Instruments toolbar allow for zooming on the schematic. Hover over selected area for more precise zooming. Notice that we have hidden the Design Manager panel to the right (*Ctrl+2* hotkeys) to get more space on the design area.

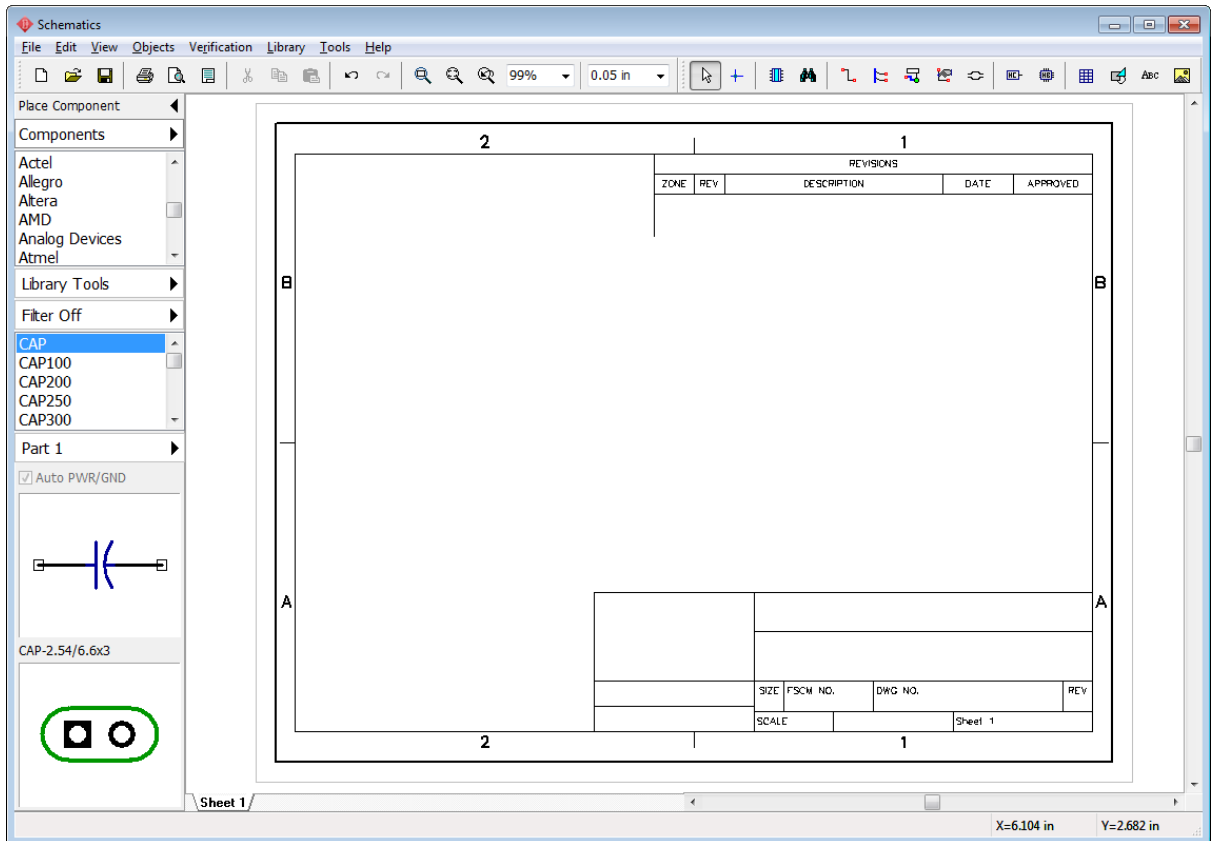

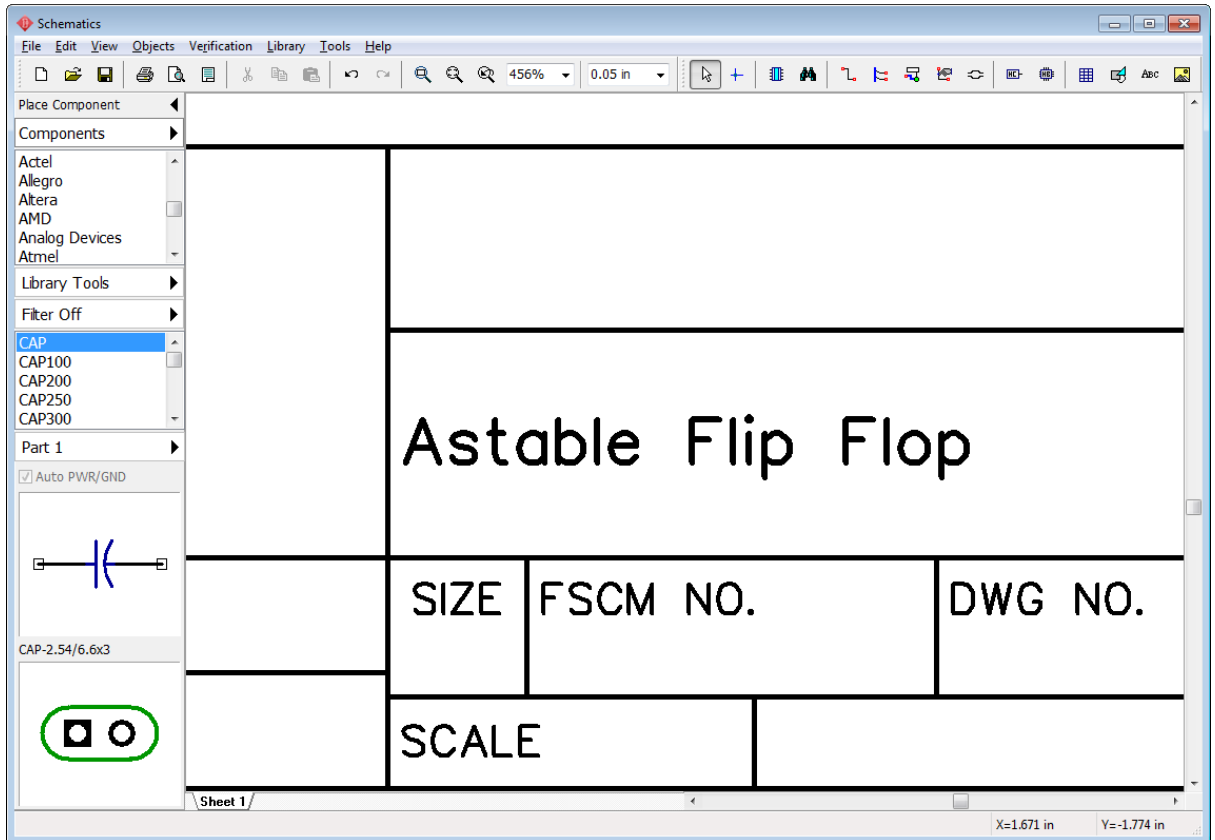

To enter text into the title field, simply hover over that field with the mouse (the field highlights green), then left-click it to open the field properties pop-up dialog box, select or type in the text (field content), define alignment (Left, Center or Right), and the font.

In our case type in "Astable Flip Flop" text, then press the **Font** button and set the font size to **12**. Then click **OK** to close the dialog box and apply changes. You can enter multi-line text into the title block fields. This text will be saved only for the current project. If you need to create a custom title template with predefined texts, please refer to **Title Block Editor** (more details in Schematic Help [Title Block Editor](#) topic).



To zoom on the title block, hover over it with the mouse, and press the *Plus Sign (+)* or scroll the mouse wheel.

Let's practice with different zoom options for a while. Click on the  button (Zoom Window) and draw a rectangle on the design area where you want to zoom.

To return to previous scale and position, use  button (Undo Scale). Press and hold the right mouse button to pan on the design area.

Go to "File \ Save As" from the main menu, type in the file name, and make sure that file is in the directory that you need. Click **Save**.

## 1.3 Configuring libraries

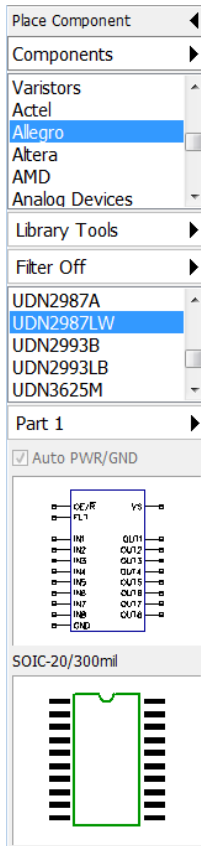

DipTrace has a single cross-module library management system. Libraries are organized to standard and custom library groups with multi-level search filters ensuring that correct components can be found quickly. The Place Component panel has all necessary tools to place components and manage libraries.

### Configuring library groups

Press **Components** (<Current Library Group>) there are three default library groups:

- Components** (all standard libraries, sorted alphabetically by component type and manufacturer);
- User Components** (add/delete libraries to/from this library group). Empty by default;
- Project Libraries** (auto-generated library with all components of the current circuit). It is empty if no schematic file is open.

Let's group all libraries that we will need for our project in a single library group. Select **User Components** library group, then press the

**Library Tools** and select **Add Library to "User Components"**. In the pop-up dialog box select **Components** library group from the **Add from Group** list. The **Components** library group contains all standard DipTrace component libraries. Select Discrete, Symbols, and Fairchild libraries, use *Ctrl* hotkey for multiple selection. Press **OK** when ready.

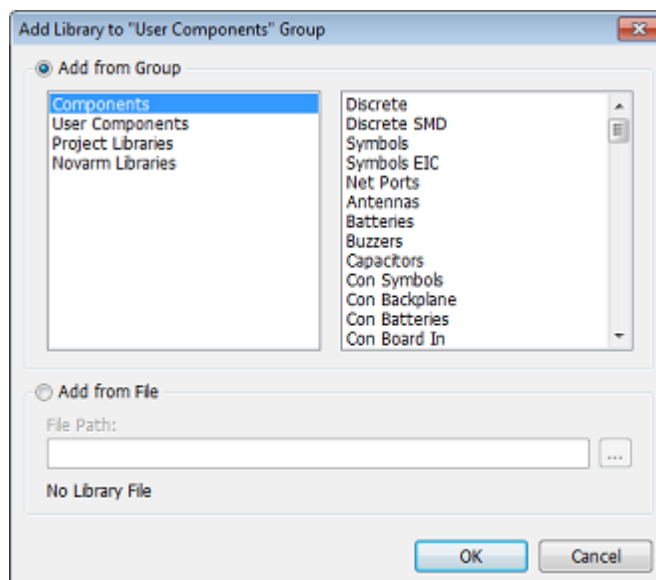

Now selected libraries appeared in the User Components library group and we are ready to start designing the schematic.

### Add library from the separate file

To add a new library to the DipTrace library system, check **Add from File** checkbox in the **Add Library to <Library group>** dialog box and select the file on your computer. You can also use the **Library Setup** dialog box to get access to the comprehensive library system settings ("User Components (<Current library group>) \ Library Setup" on the Place Component panel).

*Notice that Library Setup panel allows for configuring both pattern and component library groups, though pattern libraries are invisible in the Schematic.*

More information in the DipTrace Help ("Help \ Schematic Help" from the main menu), Working with Libraries section.

## 1.4 Designing a schematic

In this section of the tutorial we will show the basic principles of working in the Schematic module of DipTrace PCB Design Environment.

Please turn ON the grid (if it was turned OFF) with *F11* hotkey. Change the grid size to 0.1 inch, you can select it from the list of grids  on the Instruments toolbar, or press the *Ctrl + Plus Sign (+)* hotkeys to increase, or *Ctrl + Minus Sign (-)* to decrease the grid size.

*Notice that you can add new sizes by selecting "View \ Customize Grid" from the main menu. Measurement units can be changed in the "View \ Units" main menu item or with Shift+U shortcut. We note only default keyboard shortcuts in this tutorial. Go to "Tools \ HotKey Settings" to restore the defaults or change shortcuts.*

Now let's start creating the circuit. Select Fairchild library from the **User Components** library group on the **Place Component** panel.

### Search component in libraries

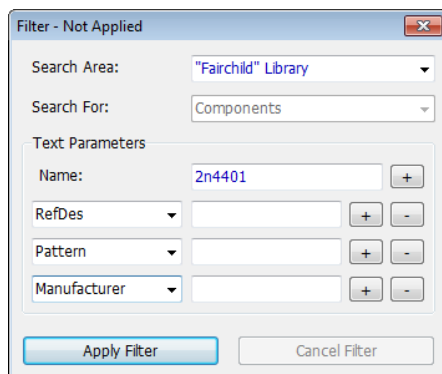

Once the library is selected, scroll down the component list to find 2N4401 transistor or use the search filters. Select "Objects \ Find Component" from the main menu or press  button.

In the pop-up dialog box make sure that Fairchild library is set as a search area, then type in "2n4401" into the **Name** field, and press **Apply Filter**. Now only the components with "2n4401" in their names appear in the component list. The filters button now shows that the filter is ON. All other components are hidden.

Close the **Search Filters** dialog box.

*Notice that you can expand the search results by entering a part of the component name as well as filter components by RefDes, value, pattern, manufacturer, datasheet, or additional fields, use the  and  buttons to add or delete the search filters.*



## Placing components

Click on the transistor in the list and move your mouse pointer to the design area. Left-click once to place one transistor. Right-click to disable the component placement mode.

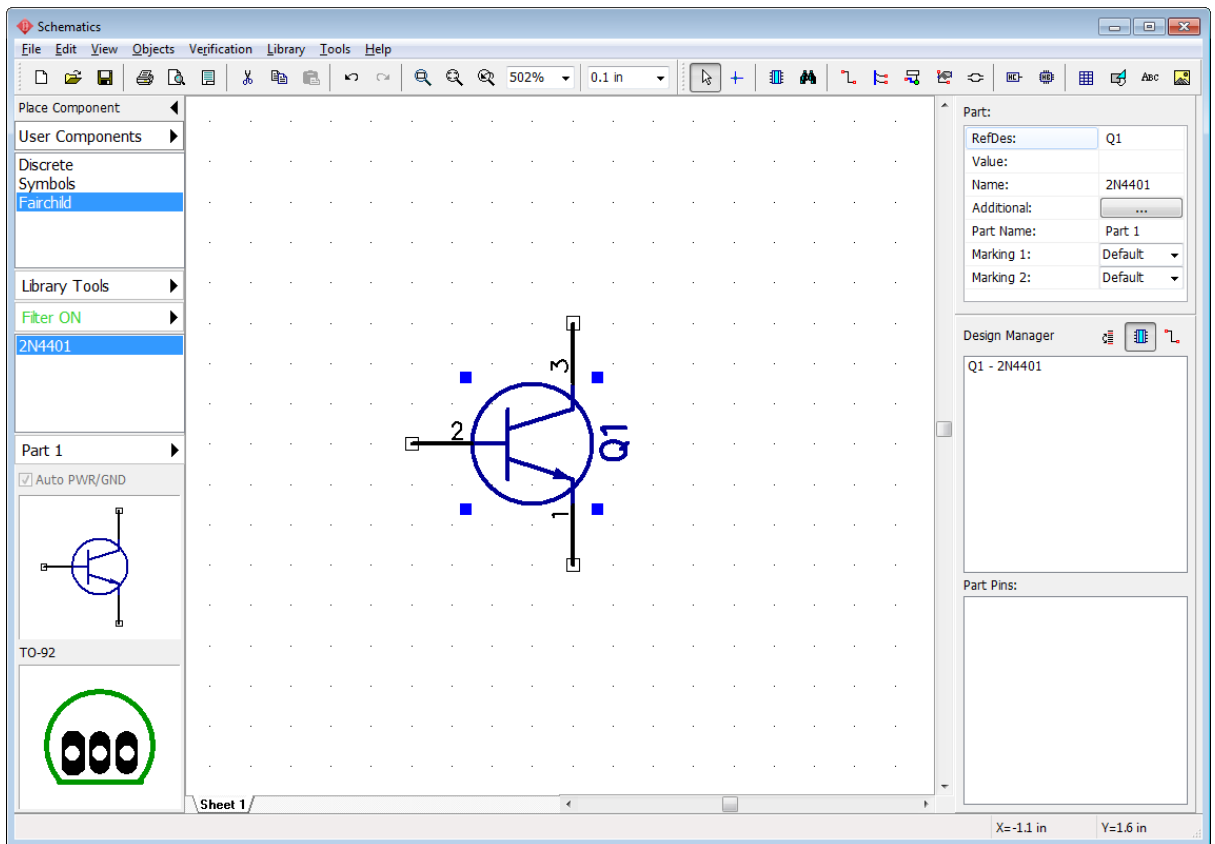

Drag and drop component if you need to move it to another location on the design area.

To select several objects, press and hold the *Ctrl* key, then left-click on each object that you want to add to the selection or move the mouse to the upper-left corner of the group, hold down the left mouse button and move cursor to the lower-right corner, then release the mouse button to select all objects inside the rectangle (press *Ctrl* key to invert selection). Now you can move these objects at a time.

Sometimes it is necessary to change the reference designator of the component. Hover over the component with the mouse pointer, right-click it, and select the top item (Q1) from the submenu. In the pop-up dialog box type in a new RefDes if needed. We will keep "Q1".

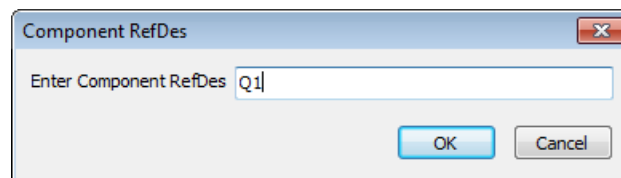

We need two transistors for the schematic, select 2N4401 in the component list again, and place it on the design area. If you have changed the reference designator you don't need to rename the second transistor, it happens automatically. If you want to rotate the component before placing it on the design area, press *Space* or *R* default keyboard shortcuts.

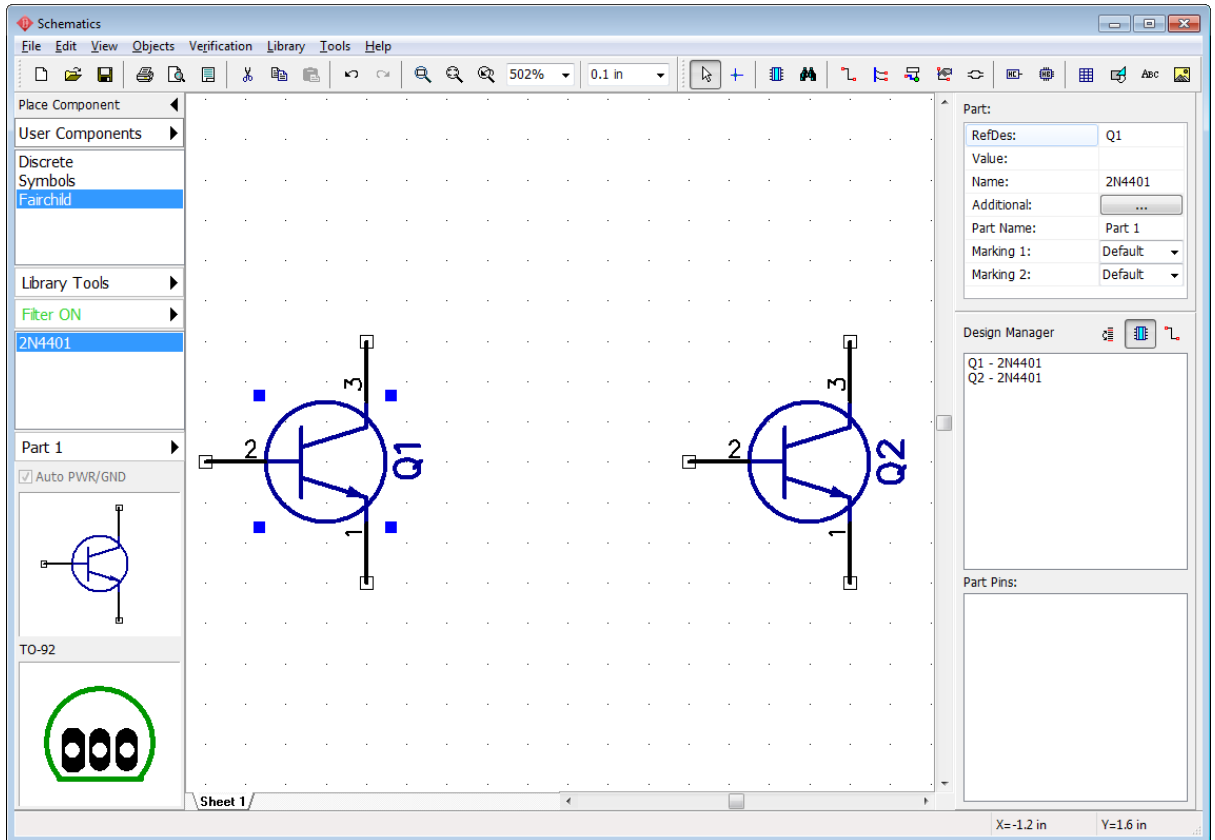

When the search filter is active, you can see only certain (filtered) components of the library. Press **Filter ON** button on the **Place Component** panel, then press **Cancel Filter** in the pop-up dialog box to turn the filtering OFF. Now close the search filters dialog box.

Select Discrete library, find RES400 resistor, and place it on the design area. "400" in the resistor's name stands for 400 mils of lead spacing. If you prefer metric units, switch units with *Shift+U* combination, however, we will keep inches as these are the most suitable units for the current project.

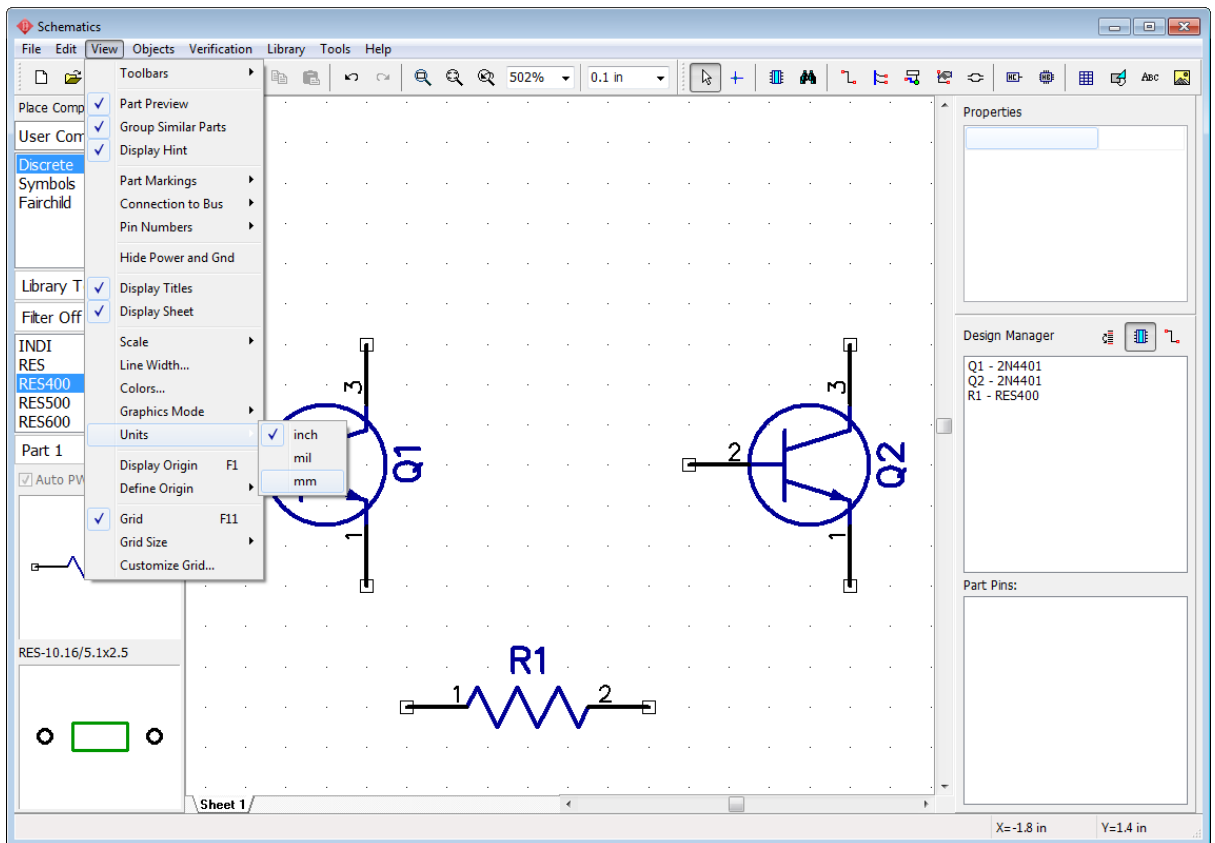

### Copy components

We need 4 resistors for this project. You can place them manually, like Q1 and Q2 transistors, but this time we select one resistor on the design area and copy it three times. There are two ways to copy a component:

1. Once a component is selected, go to "Edit \ Copy" from the main menu or right-click on the component, and select **Copy** from the submenu, (*Ctrl+C* hotkeys), then select "Edit \ Paste" three times, or right-click on the design area, and select **Paste** from the submenu.
2. Copy Matrix, good for bulk copying. Select resistor, then go to "Edit \ Copy Matrix" from the main menu (or press *Ctrl+M* hotkeys).

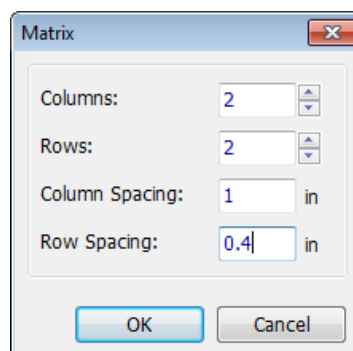

In the **Matrix** dialog box set the number of columns and rows ("2" columns and "2" rows to get 4 resistors) and spacing (1 inch for columns and 0.4 inch for rows are good), click **OK**. Now you can see four resistors on the design area:

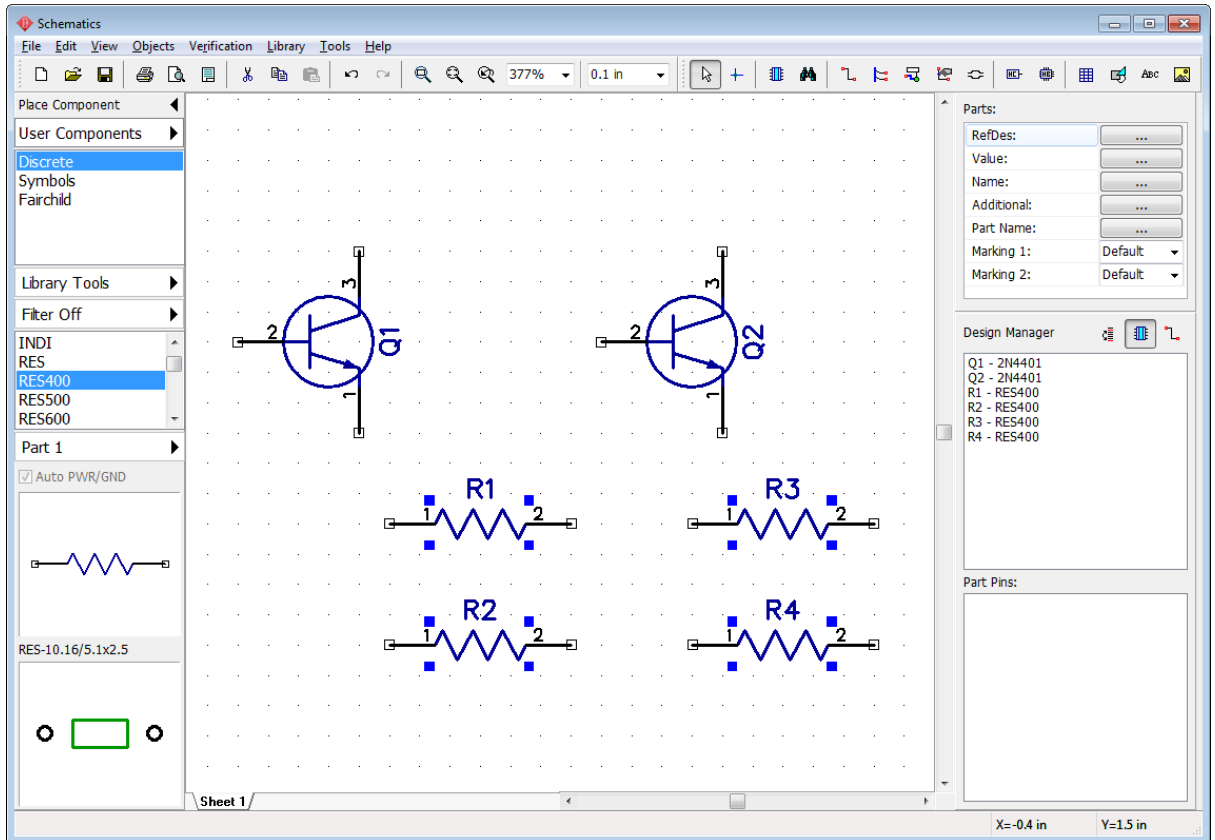

Move resistors to a proper location, like in the picture below (use mouse or arrows on the keyboard for orthogonal moving), and rotate components 90 degrees (use *Space* or *R* shortcuts to rotate selected components). Another method to rotate an object is using the "Edit \ Rotate" main menu item or right-clicking on the object and selecting **Rotate** from the submenu.

*Notice that you can pan design with the right mouse button or the mouse wheel: move mouse arrow to the design area, hold down the right mouse button or the mouse wheel, and pan.*

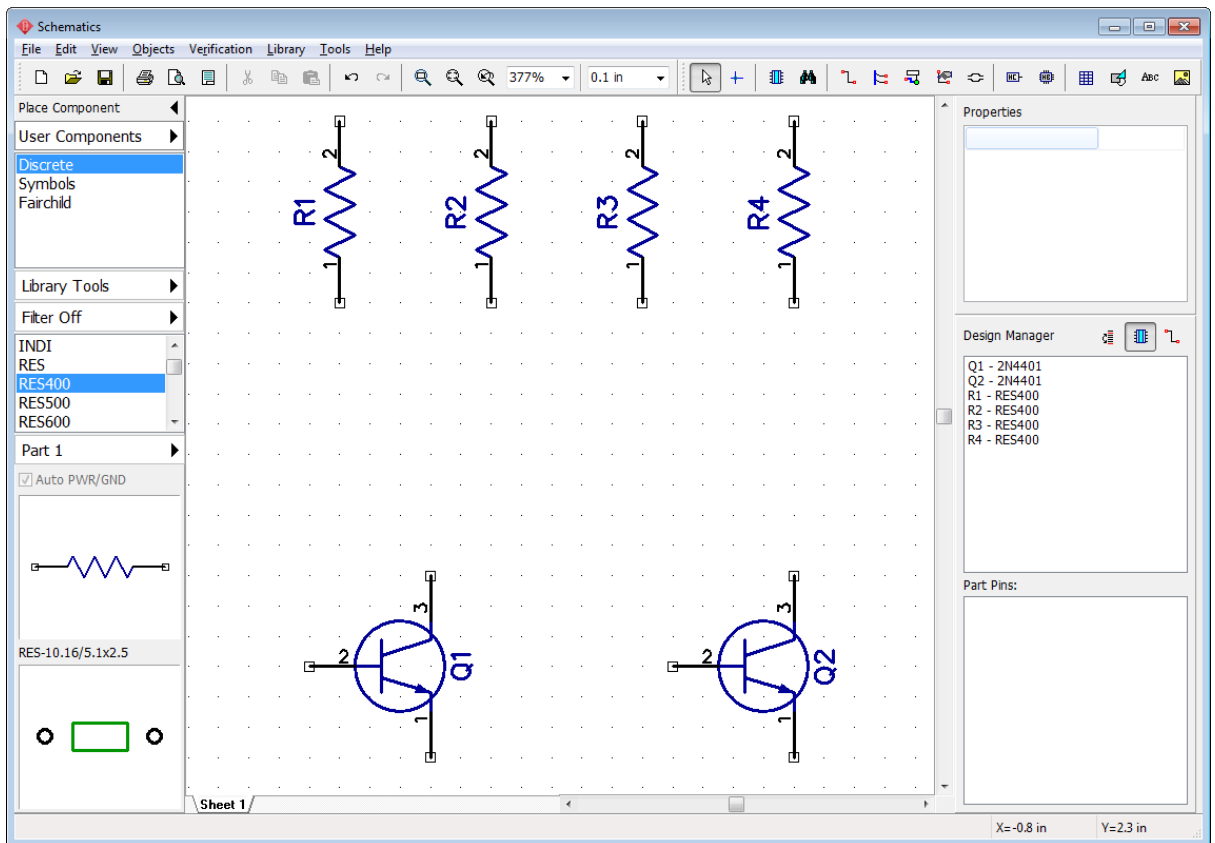

### Components' markings

The reference designators of Q1 and Q2 transistors have inappropriate locations, we need their RefDes to be under the component symbols. To change the RefDes location, select both transistors, right-click on one of them, and select **Properties** from the submenu. In the pop-up dialog box select the **Markings** tab, and specify: "**Justify: Bottom**" in the **Main Marking** section.

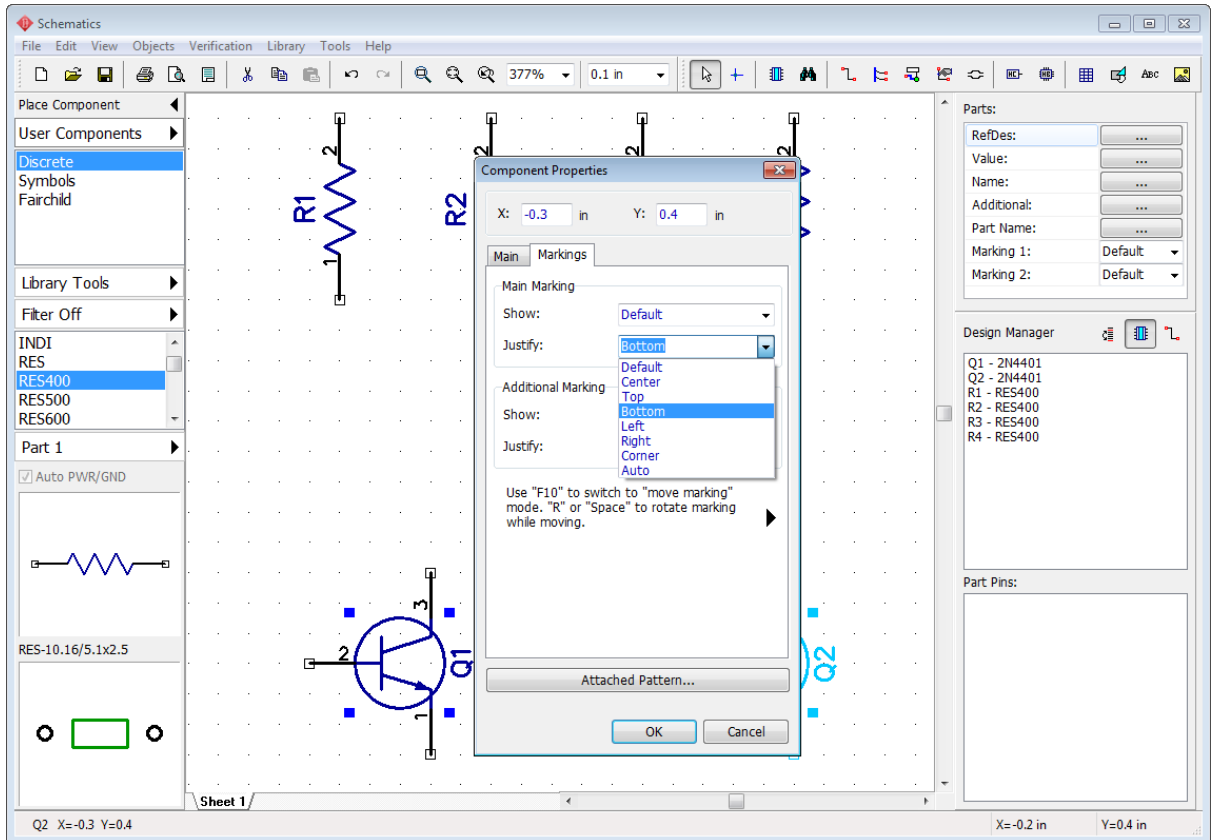

Press **OK**.

Let's display component names for these transistors. Select the transistors again (if not selected yet), and set "**Show: Name and Part**" and "**Justify: Corner**" in **Additional Marking** section in the **Markings** tab of the **Component Properties** dialog box. This will show the names of selected components. Notice that reference designators are already displayed as primary markings. **Default** means using common Schematic settings for all components. Displaying RefDes is a common property.

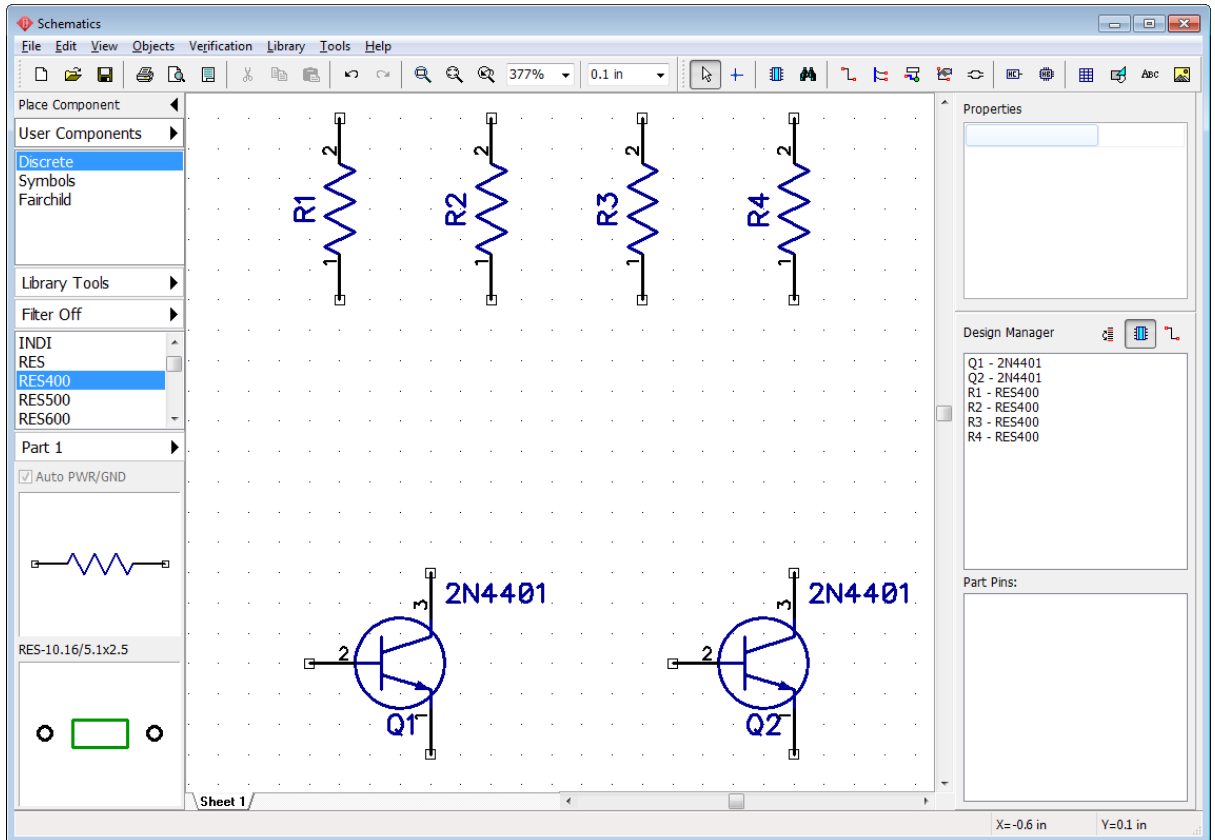

If you want to edit precise markings' positions, press the **Unfold** (right arrow button under the Additional Marking section).



You can show or hide the pin numbers for the entire circuit by selecting "View \ Pin Numbers \ Show" from the main menu if they are not displayed yet. To change pin display settings for selected part, right-click it, and select **Pin Numbers** from the submenu.

However, if you're still not satisfied with location of RefDes, numbers, pin names or any other markings, you can move them around visually with a special move tool. Select "View \ Part Marking \ Move Tool" from the main menu or press *F10*. We recommend to turn OFF the grid for precise moving (*F11* hotkey). You can move and rotate part markings like separate objects with *R* or "Space" shortcuts.

"View \ Part Marking" menu item allows the user to change common settings of part markings. Common settings are applied to all schematic parts, except those with custom properties.

Use **Undo** or **Redo** tools (   buttons) if you are not satisfied with the changes you've made. The DipTrace saves up to 50 steps. Remember to save schematic into the file. Select "File \ Save" from the main menu or press the **Save** button on the Standard toolbar. If current schematic has never been saved, the **Save As** dialog box will pop up to define the file name and location. If the file exists, clicking the **Save** button or pressing *Ctrl+S* hotkeys is enough. You can use the "File \ Save As" dialog box to save the same file under a different name, for example, in order to backup it.

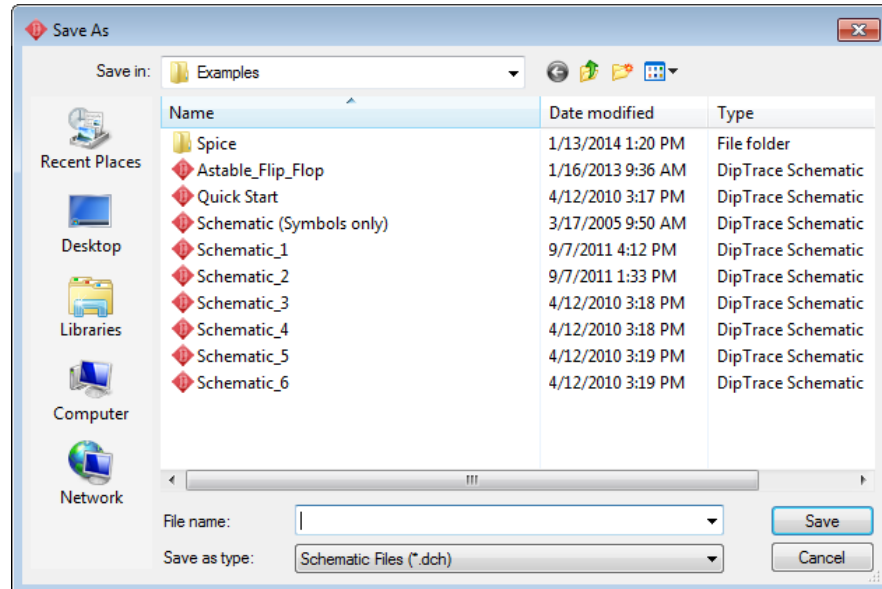

### Create connections

Connect pin 1 of R1 resistor to pin 2 (base) of transistor Q1. You need to make sure that you are in the default mode (  button is pressed). Hover with the mouse arrow over the bottom pin of R1 resistor, and left-click it. Then move the mouse arrow down to the base pin of the Q1 transistor, and left-click it to connect the wire and create the connection between R1 and Q1.

Now we need to mirror the Q2 transistor, this will make schematic more easy to understand. Right-click on the transistor, and select "Flip \ Horizontal" from the submenu.



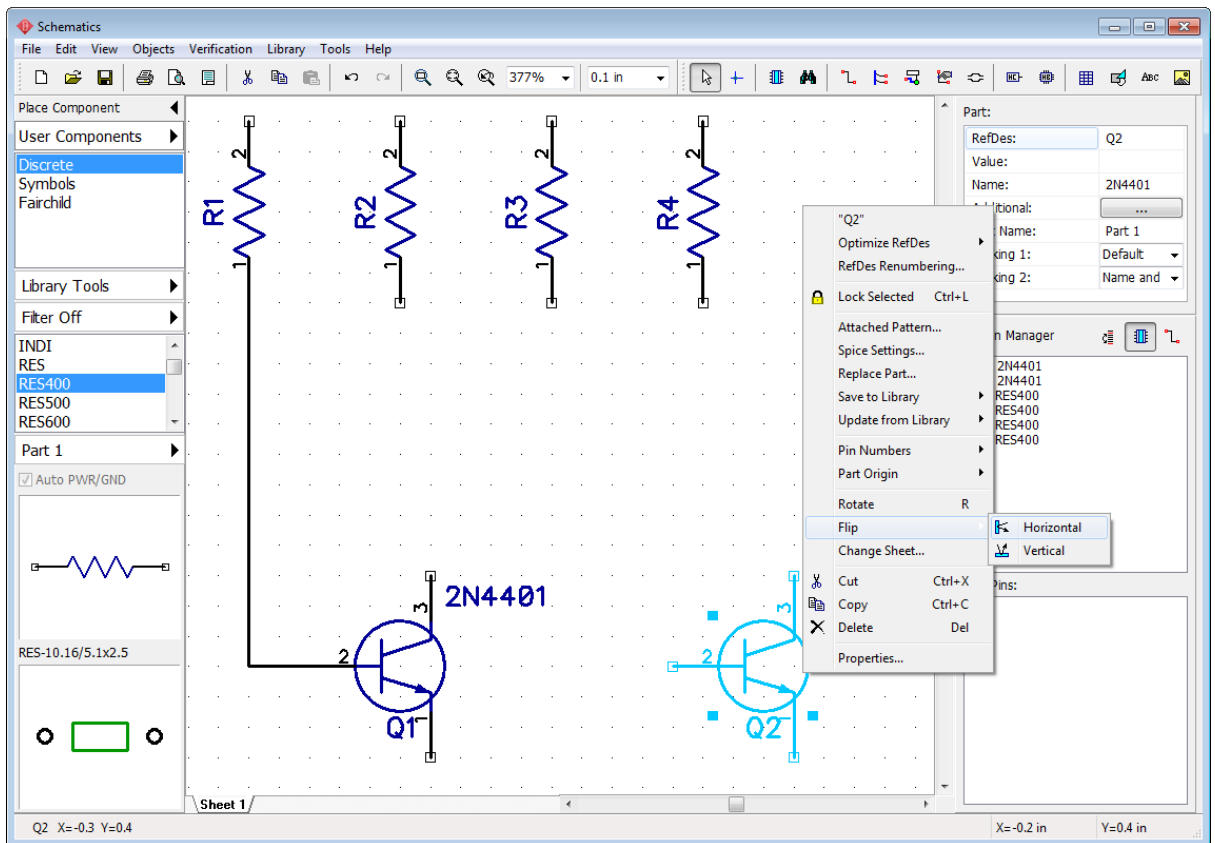

Connect R4 to pin 2 (base) of Q2, R2 to pin 3 of Q1, and R3 to pin 3 of Q2, like in the picture below. You can move components or wires to get straight lines, this is not important for electrical connectivity, but for esthetic pleasure and in order to make schematic well-organized and easy to understand. If you don't like the automatic wire placement mode, you can turn it OFF on the **Place Wire** panel on the **Design Manager** to your right-hand side. Set **Manual** in the **Route Mode** section or just press the *M* hotkey. The Place Wire panel is only visible in the wire placement mode.

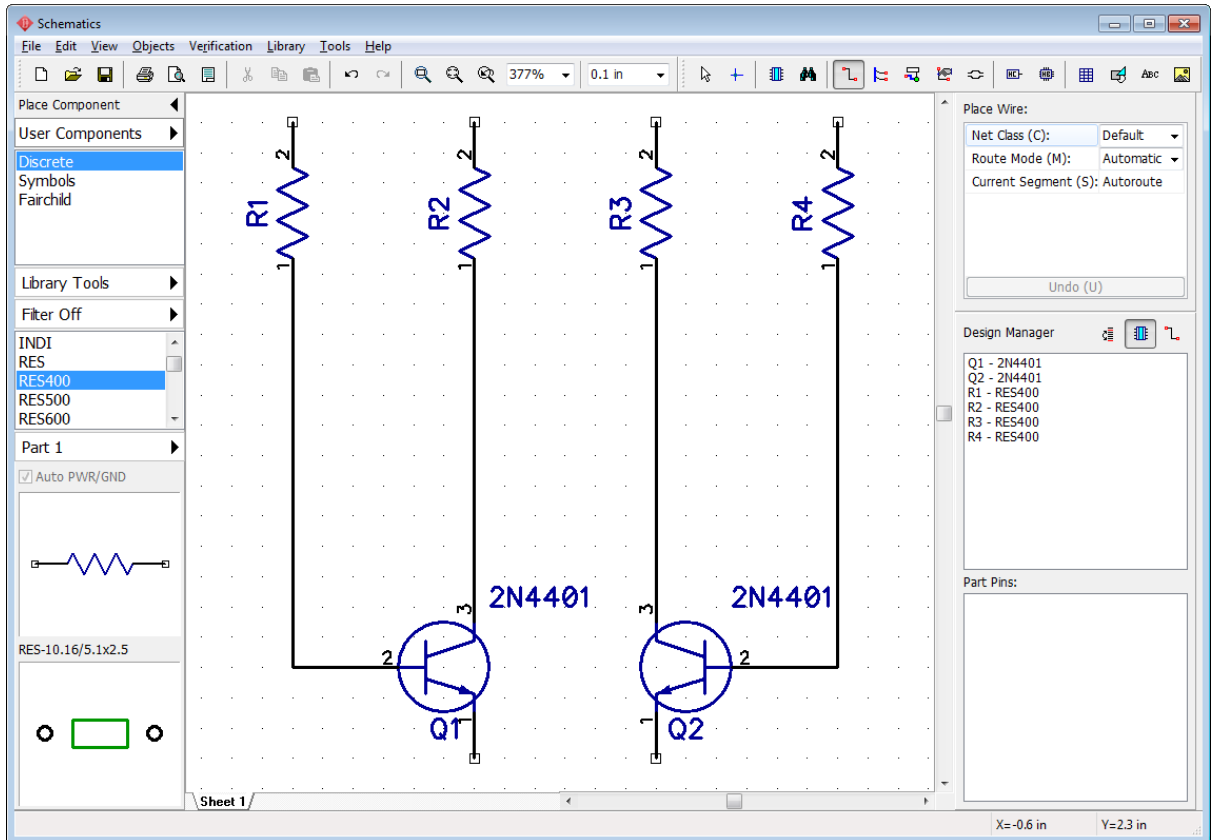

Now select CAP100RP from the Discrete library and place it twice to the design.

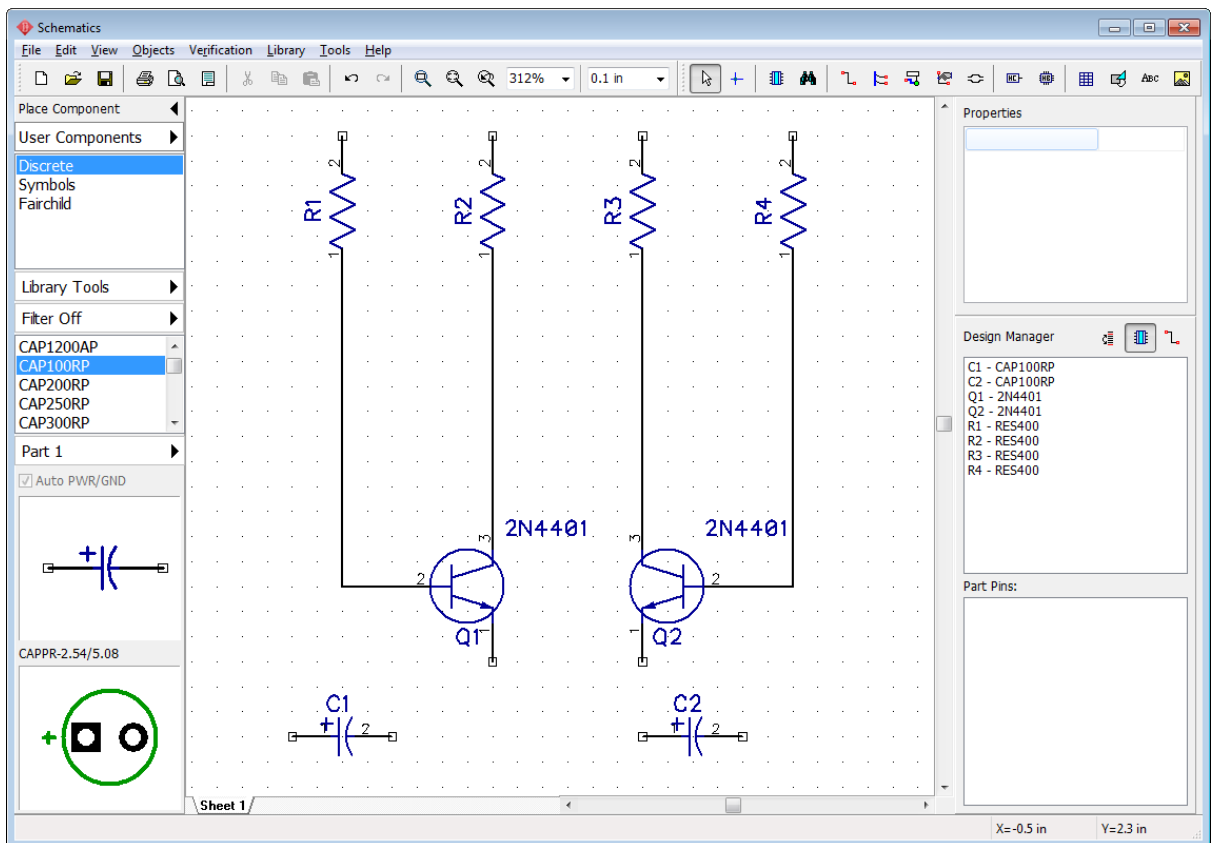

Flip C2 capacitor, select "Flip \ Horizontal" from the right-click submenu. C2 capacitor's positive pin should be facing right.

We need to place two capacitors between the transistors Q1 and Q2 with respect to their polarities.

You might need to move some components to give enough space for the capacitors and connections.

Move resistors a bit upwards, and select Q2, R3, R4 and related wires in order to move them to the right a little bit. Draw the selection box around these objects by holding down the left mouse button.

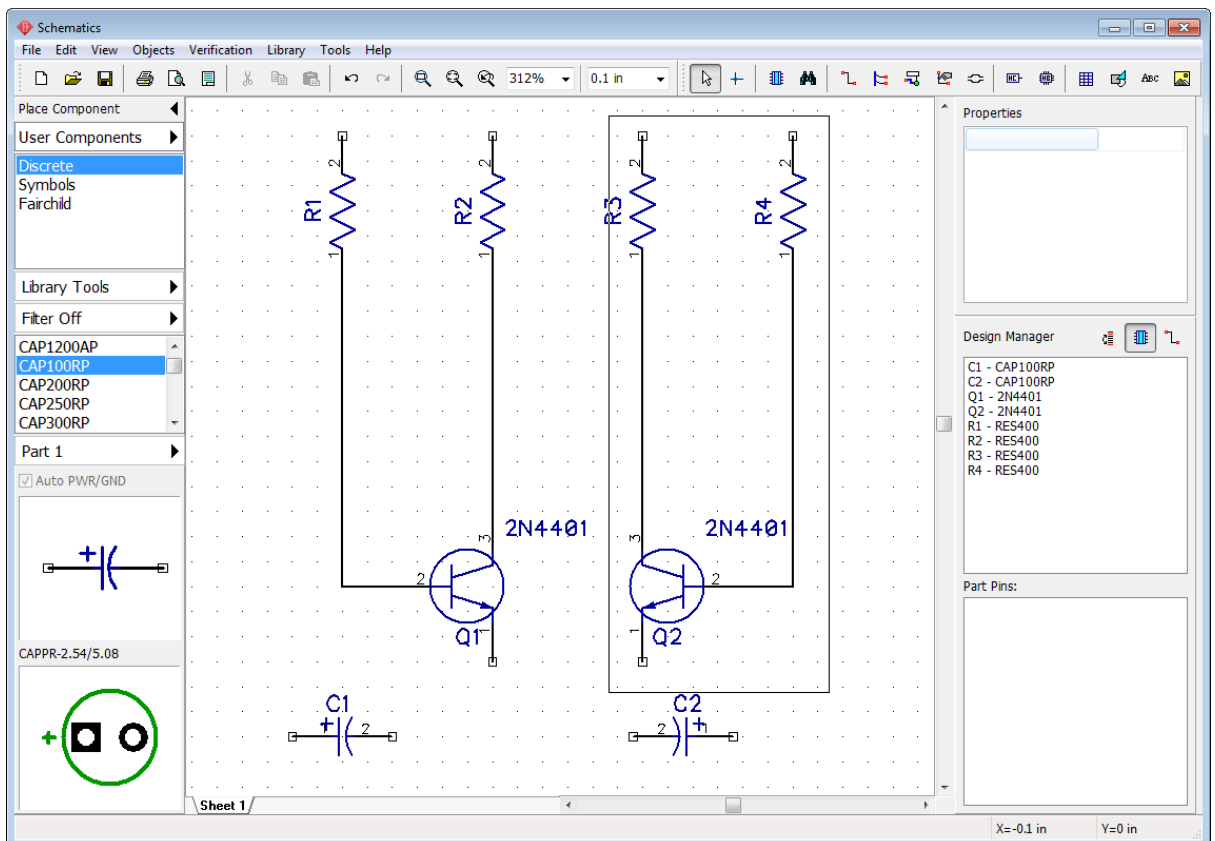

Use the right-click to deselect all if you are in the Default mode, or double right-click if you are in another mode (first click to disable an active mode and the second click to deselect all).

Connect the positive pin of the C1 to pin 2 of the Q1: left-click the C1 positive pin and left-click on the wire between the R1 and Q1, the small circle appears if wires are properly connected.

Then connect C1 pin 2 and C2 pins like in the picture below.

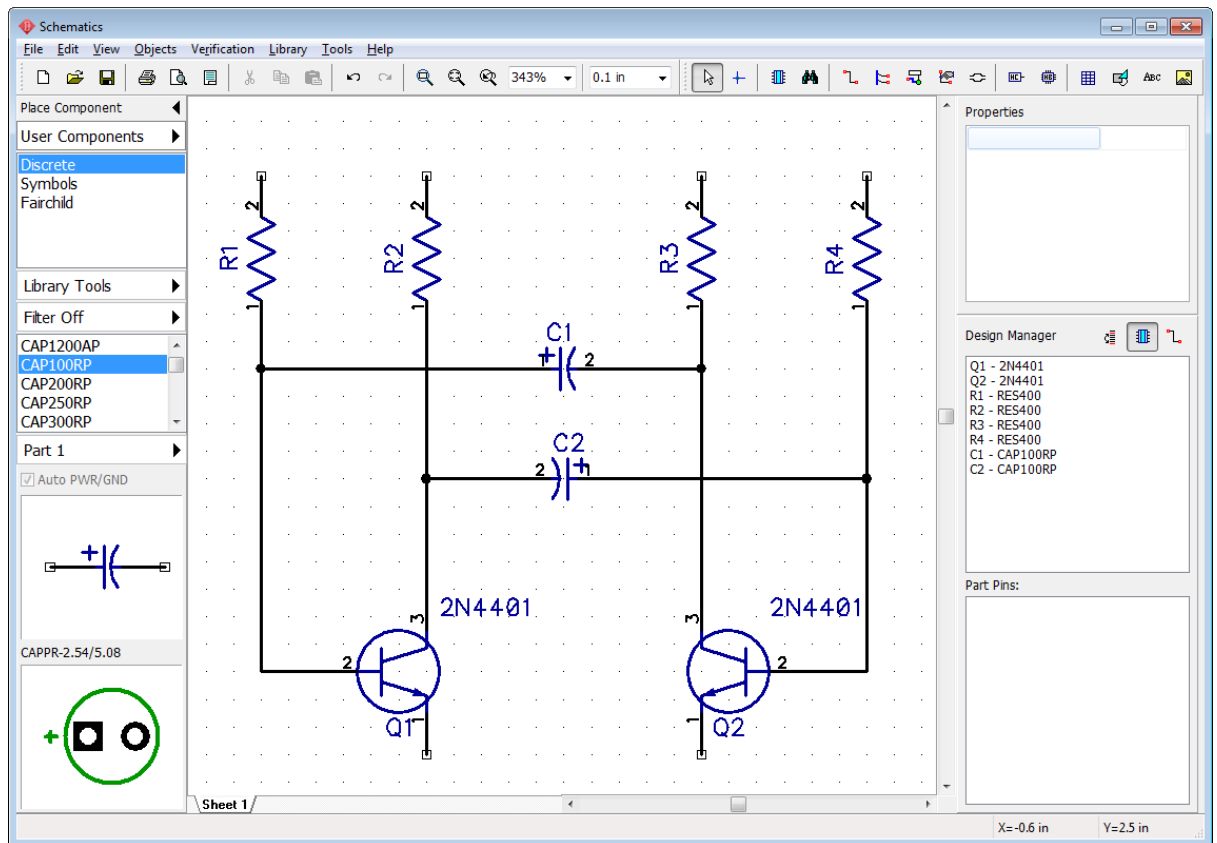

Scroll down the components list (Discrete library) on the **Place Component** panel to find the LED component, and place two of them onto the schematic. Then change the reference designators to "LED1" and "LED2" (right-click on the component, and select the first item from the submenu), rotate these parts with *R* hotkey or *Space* (pressed three times). Probably, you'll need to move and rotate the RefDes with the Move tool (*F10* shortcut). Then connect LEDs to transistors like in the picture below.

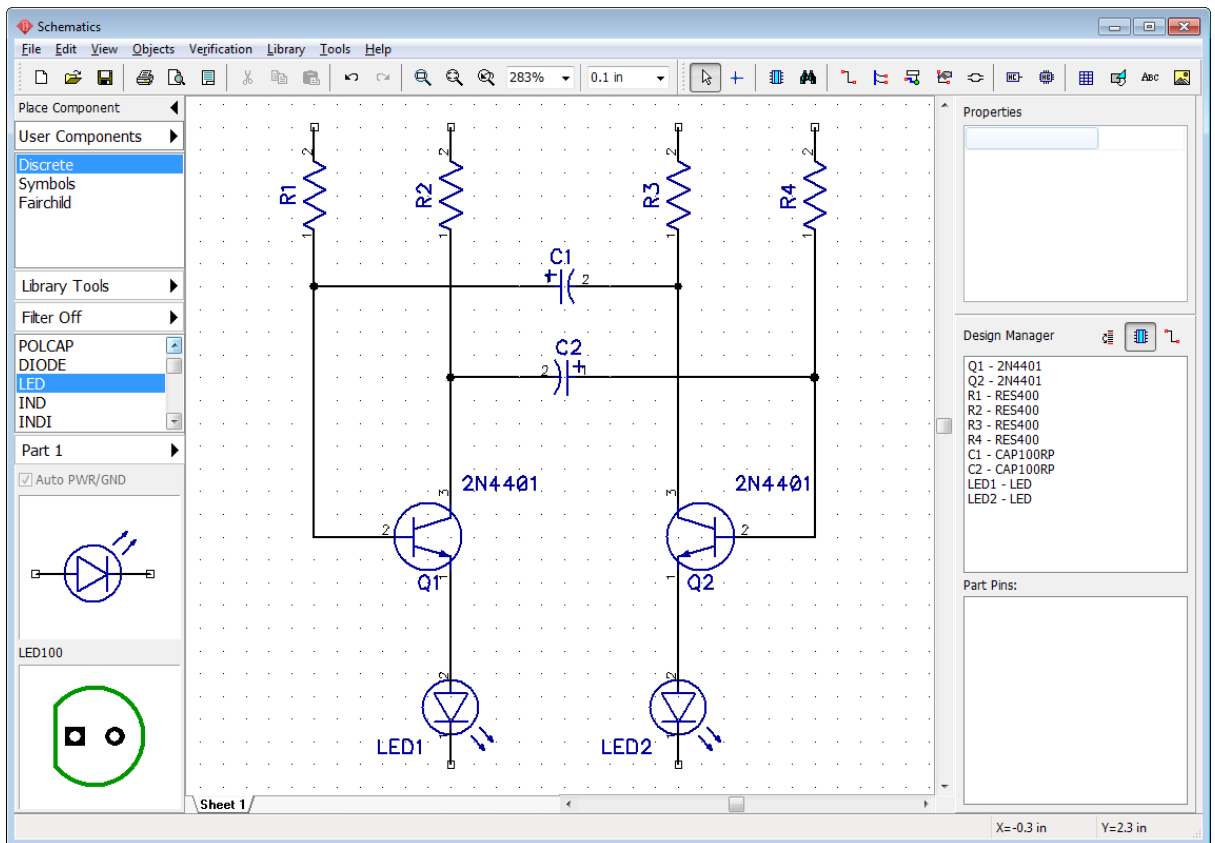

Place a battery symbol SOURCE\_BATTERY2 component from the Symbols library, change its RefDes if you need, and complete the circuit by connecting all the rest (see the picture). Make sure that you see small black circles where two wires connect, if not, then wires are not connected.

Notice that you can align components in rows or columns automatically respective to each other, just select the components that you want to align, right-click on one of them, select **Align Objects** from the submenu, and set up the alignment tool properly. However, it's not needed for the current schematic.

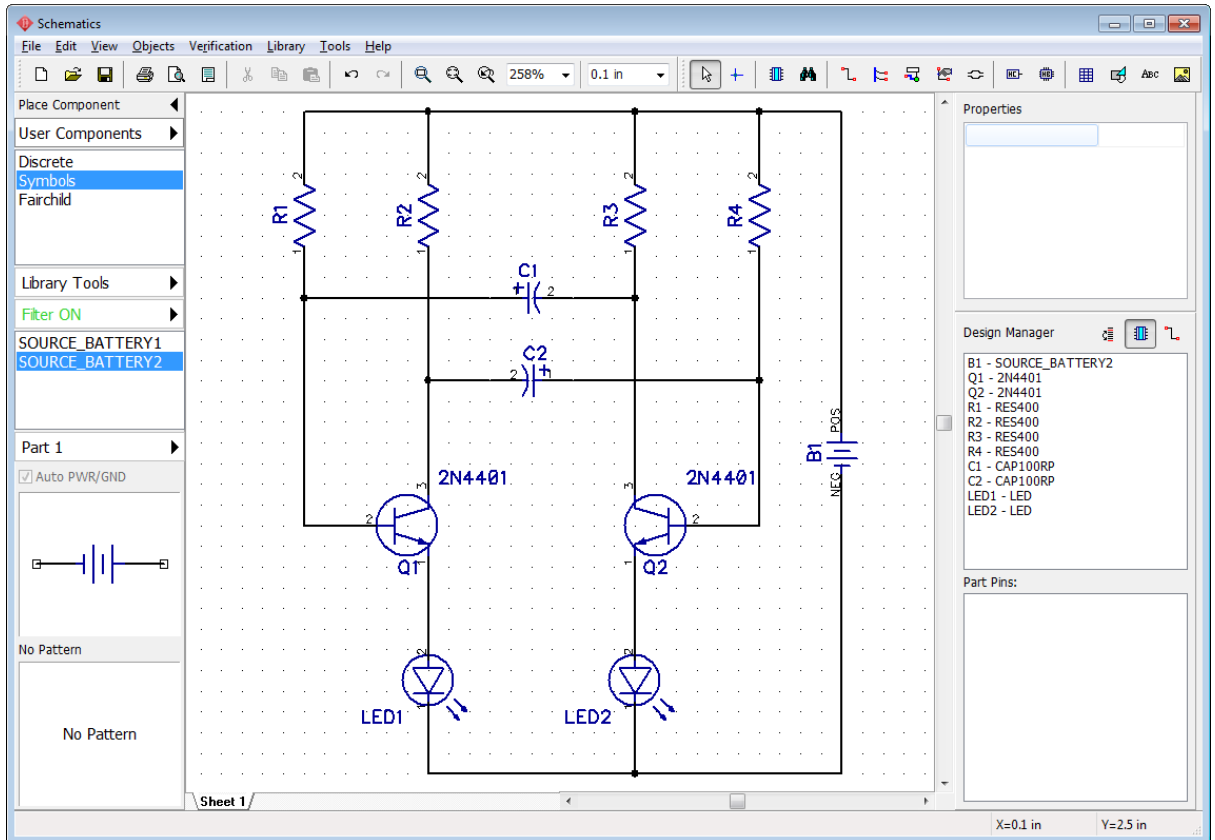

If you want to move existing wire, hover over it with your mouse (the net should highlight and the mouse cursor shows possible directions), then left-click on the wire and move it while holding the left mouse button.

Notice that if you are in the **Place Wire** mode and you click on the existing wire, you start to create a new wire, not editing an existing one. The Place Wire mode is enabled automatically when you left-click on any component pin.

If some objects do not highlight when you hover over them with the mouse, right-click on any free spot on the design area to switch to the Default mode. If you want to delete a wire, right-click it to open the submenu, and select **Delete Wire**. To delete a wire segment, select **Delete Line** from the same submenu. You can use the **Undo** to return to the previous state of the circuit.

Now we will add resistance values "10k " for all resistors on this schematic. Since " " is a Unicode character, it doesn't work in vector fonts, which are set by default in DipTrace. We need to switch TrueType fonts for part markings in order to use the Unicode characters. Go to "View \ Part Marking \ Font \ TrueType". Since TrueType characters look a bit different from Vector ones, you might need to adjust the font size. We made it a little bit bigger (8 pt).

Notice that there are various ways to enter special characters. We recommend to copy symbols from the **Character Map** ("Start \ All Programs \ Accessories \ System Tools \ Character Map" in Windows OS), and paste them in the DipTrace.

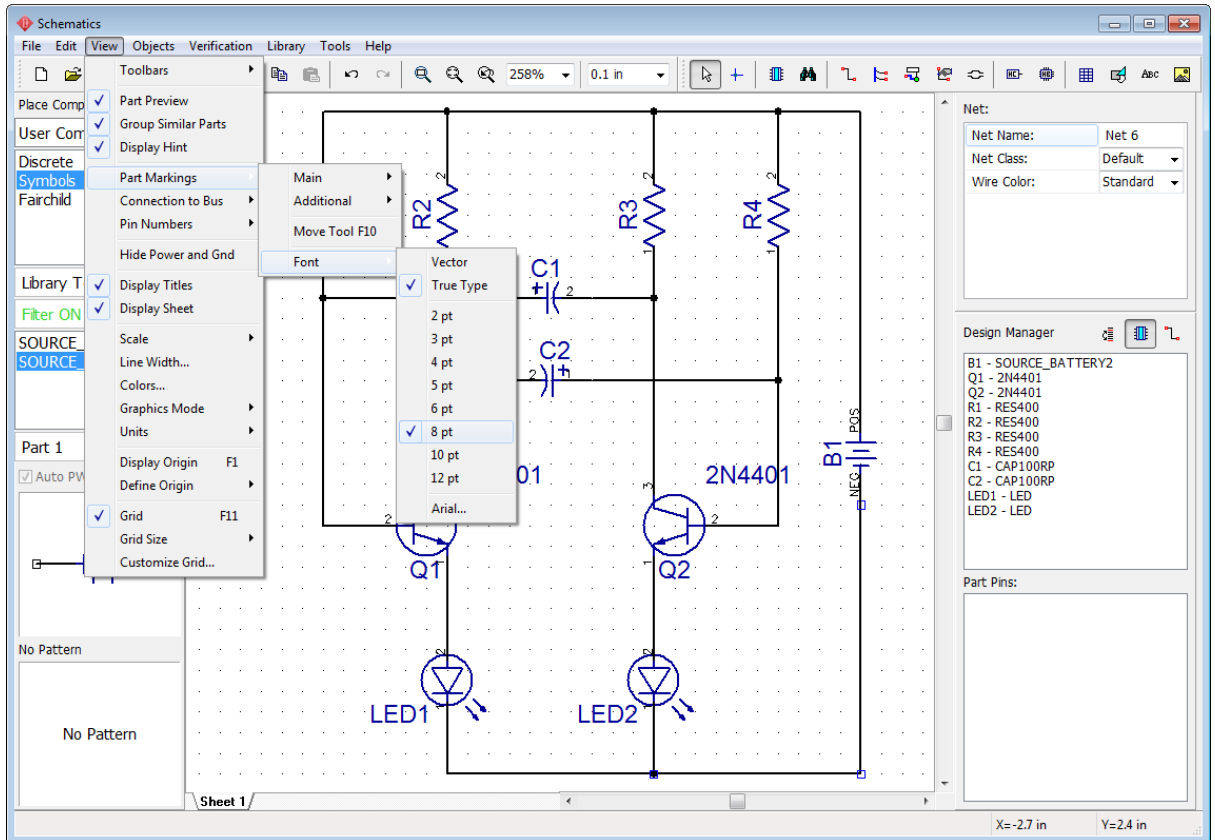

Now select all resistors, then right-click on one of them, and select **Properties** from the submenu. Select the **Main** tab and type "47 k " into the **Value** field. Now click on the **Markings** tab, specify "**Main Marking \ Show \ Value**", then specify "**Additional Marking \ Show \ RefDes**", and click **OK**.

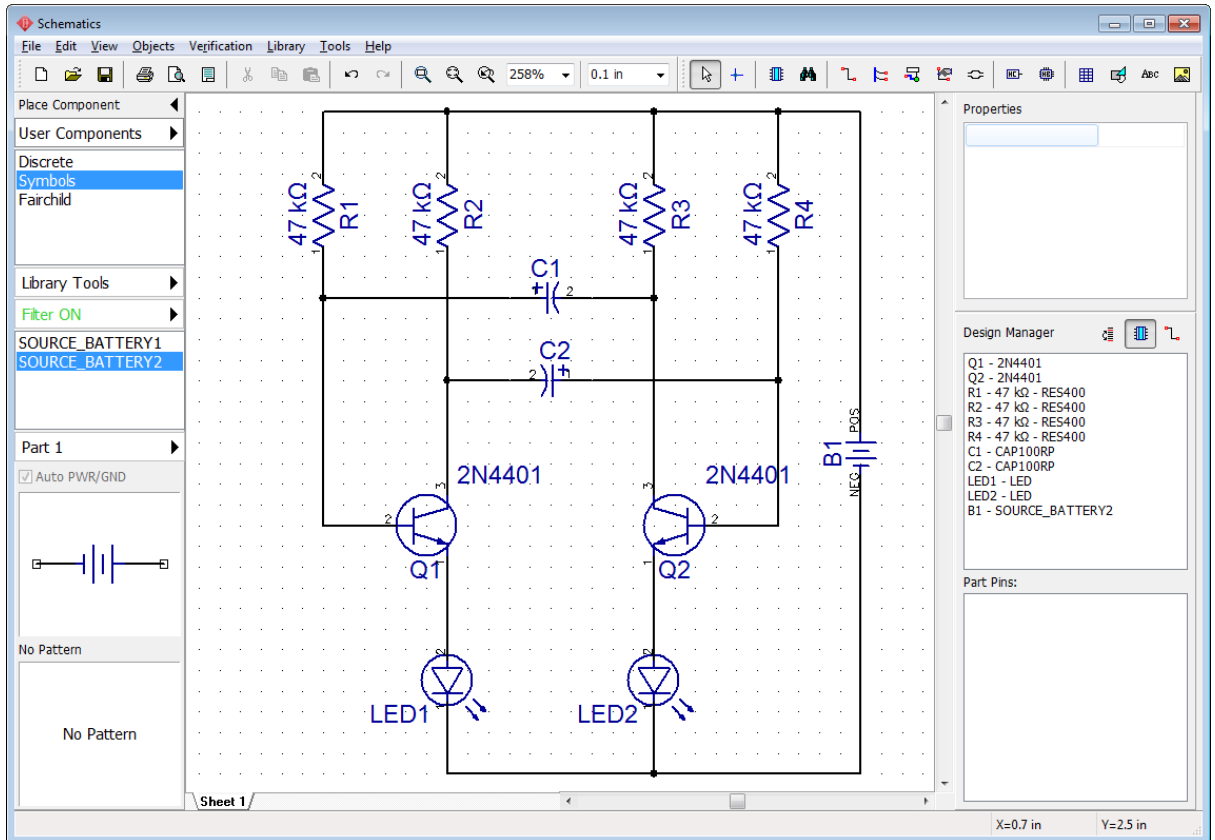

As you remember, we took the battery component from the Symbols library. All components in this library don't have patterns, it's just symbols (pattern preview field on the Place Component panel says "No Pattern"). But in order to proceed to the PCB layout stage, you should attach the related pattern to this symbol. If left blank, DipTrace will not be able to show this component on the circuit board and an error dialog box will pop up.

Hover over the battery symbol, right-click it, and select **Attached Pattern** from the submenu. In the pop-up dialog box you can see the list of all components of the current circuit in the left part of the dialog box, make sure "B1-SOURCE\_BATTERY2" is selected (you see the battery symbol in the preview field).

Select **Patterns** library group from the **Pattern Libraries** drop-down list on the right. This library group contains all standard DipTrace pattern libraries separately from the symbols. Select **Misc** library from the list and find the **BAT-2** pattern in the pattern list at the bottom-right of the dialog box (use the search filters if you want). In most cases, DipTrace automatically assigns pin-to-pad connections according to the pad numbers, but this is not the case with this battery symbol.

Positive pad is usually square shaped and negative is round. Click on the corresponding row in the **Pin to Pad Table**, and type in related pad number in the **Pad Number** column (NEG pin should refer to Pad #2, POS pin – to Pad #1).

You can visually set pin to pad connections, just left-click on the pin in the symbol preview field, and then on the corresponding pad in the pattern preview field.



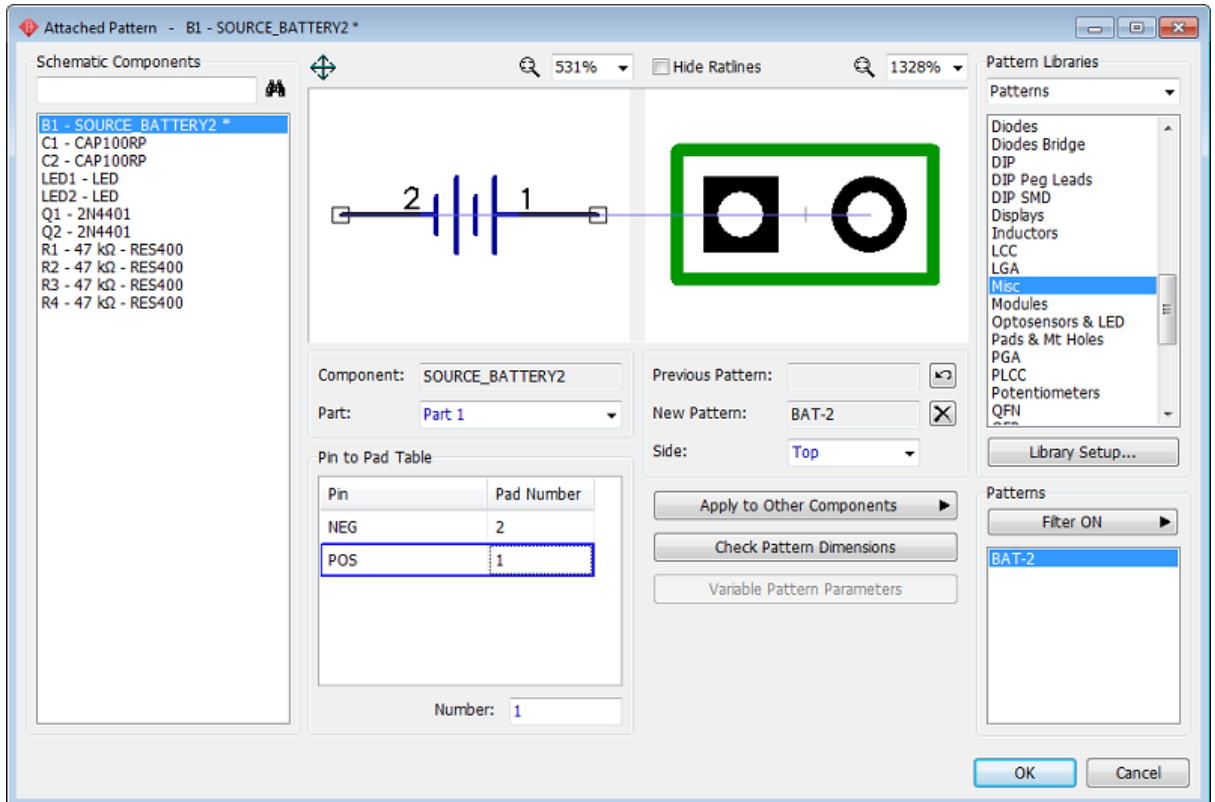

Press OK when ready to close the **Attach Pattern** dialog box.

*Notice that some symbols in the libraries are intentionally made without attached patterns (for example, VCC, GND or other logical connectors, Net Ports).*

Our schematic is now ready to become a PCB. Do not forget to save the schematic, select "File \ Save" from the main menu or click on the **Save** button or simply **Ctrl+S**.

You can print schematic or save it in BMP or JPG file. To print in PDF, you need to install any of the free PDF printers widely available online, and select it in the printer selection dialog box.

Select "File \ Preview" from the main menu, in the pop-up dialog box customize the preview, and press **Print All** to print all schematic sheets, or press **Print Current Sheet** to print selected sheet, press **Save** to create a BMP/JPG file with defined resolution.

## 1.5 Converting to a PCB

You can open DipTrace schematic files (\*.dch) in PCB Layout module but if you want to save your time, select "File \ Convert to PCB" or press **Ctrl+B** hotkeys directly in the Schematic. In the pop-up dialog box you can use Schematic rules or load rules from any other PCB layout file. When you press **OK**, the schematic will open in the PCB Layout.

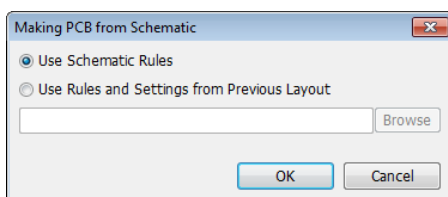

In case of incorrect exit from the program or if you somehow forgot to save the project, it is possible to recover the latest schematic by selecting "File \ Recover Schematic" in the Schematic or "File / Recover Board" in the PCB Layout module.

If you want to hide the Design Manager to get more space on the design area, press *Ctrl+3* hotkeys or uncheck "View \ Toolbars \ Design Manager" main menu item.

## Part II: Designing a PCB

### 2.1 PCB Layout UI

DipTrace PCB Layout's main window includes the design area, the main menu, toolbars, the Place Component panel, Design Manager with layers/objects/properties panel, and the status bar.

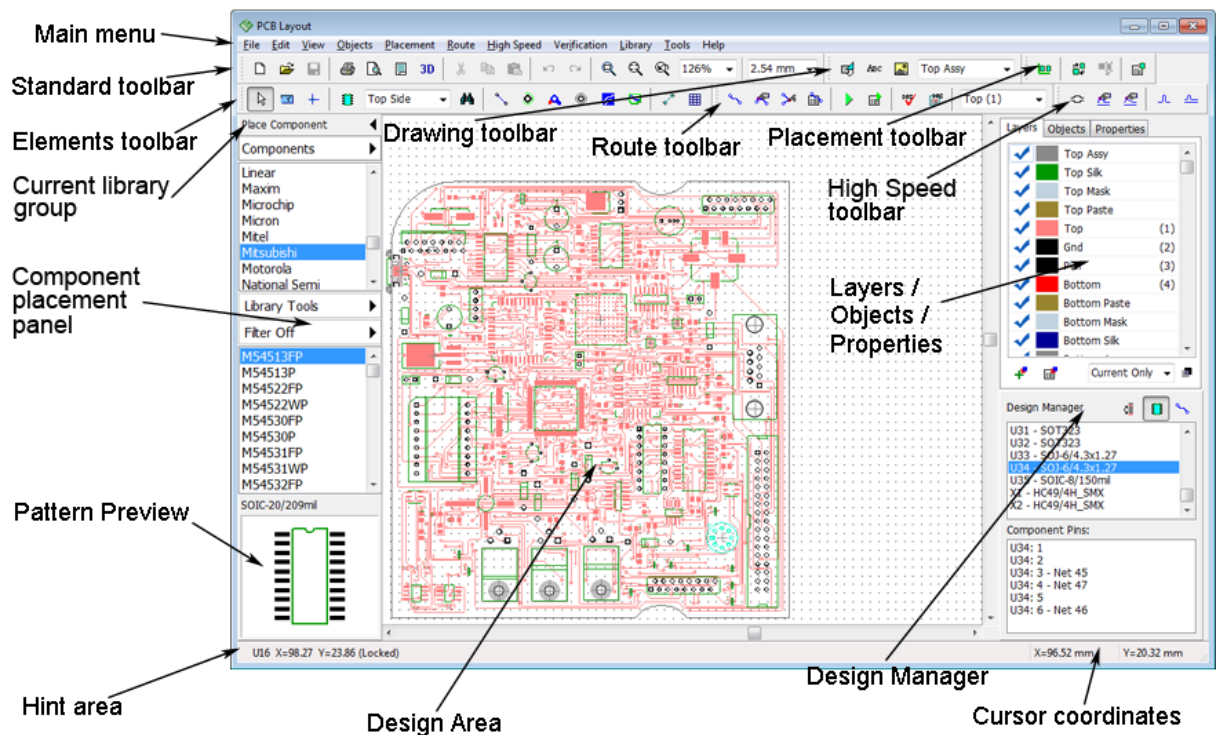

You can place and edit different objects (components, ratlines, traces, copper pours, shapes, tables etc.) on the design area. The main menu provides access to all common features.

Other interface elements:

**Standard Toolbar** – tools to work with files, cut/copy/paste objects, print, preview and configure titles, launch 3D Preview, change scale and grid size.

**Elements Toolbar** – tools to switch to the default mode, measure, change origin, place components, ratlines, pads, vias, mounting holes, copper pours, dimensions, and tables.

**Route Toolbar** – tools to create and edit traces, create a board outline, run and setup the autorouter, check design rules, select current signal layer.

**Placement Toolbar** – placement and auto-placement tools.

**Drawing Toolbar** – tools to create shapes, text, insert images, and select shape and text placement layer.

**High Speed Toolbar** – define differential pair, edit single trace of a differential pair, free

single trace editing mode, add meander, and phase tune tool.

**Place Component panel** – select library, select component and place it on the design area. Library groups, library tools, search filters, pattern preview.

**Layers / Objects / Properties panel** (active tab depends on current selected object/tool mode).



The **Layers** tab allows for working with layers (show/hide, add/delete/edit, change position and layer color) and changing layer display mode;

The **Objects** tab allows the user to show/hide different objects on the design area and block certain objects from being selected;

The **Properties** tab shows properties of selected tool/object and allows the user to change them.

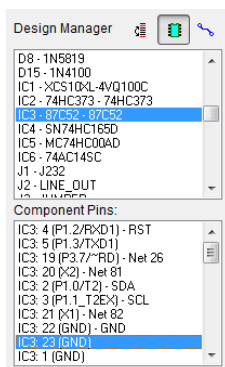
**Design Manager** – allows to quickly find any component or net in the circuit board, the same as in the Schematic.



Press  button to see the list of components, or press  button to see the list of nets. Select component or net in the list, and all pins of selected component or net will appear in the list right below. Left-click in that list to highlight object, or double click it to pan the design area to selected object.

Press  to sort the list of components or nets alphabetically (useful when changing the RefDes array or adding new components).

**Status bar** – shows a current hint to the left and cursor coordinates to the right.

Go to "View \ Toolbars \ ..." to hide/show any of the UI toolbars (or use *Ctrl+1* through *9* hotkeys). See DipTrace Help for details ("Help \ PCB Layout Help" from the main menu).

## 2.2 Preparing to route

The routing itself is one of the final stages of board design, but its quality greatly depends on the preparation.

Right after converting to the PCB, the circuit looks chaotic. Press  button on the Placement toolbar or select "Placement \ Arrange Components" from the main menu, all components will be placed near the design center (blue line cross) and arranged according to the placement settings.

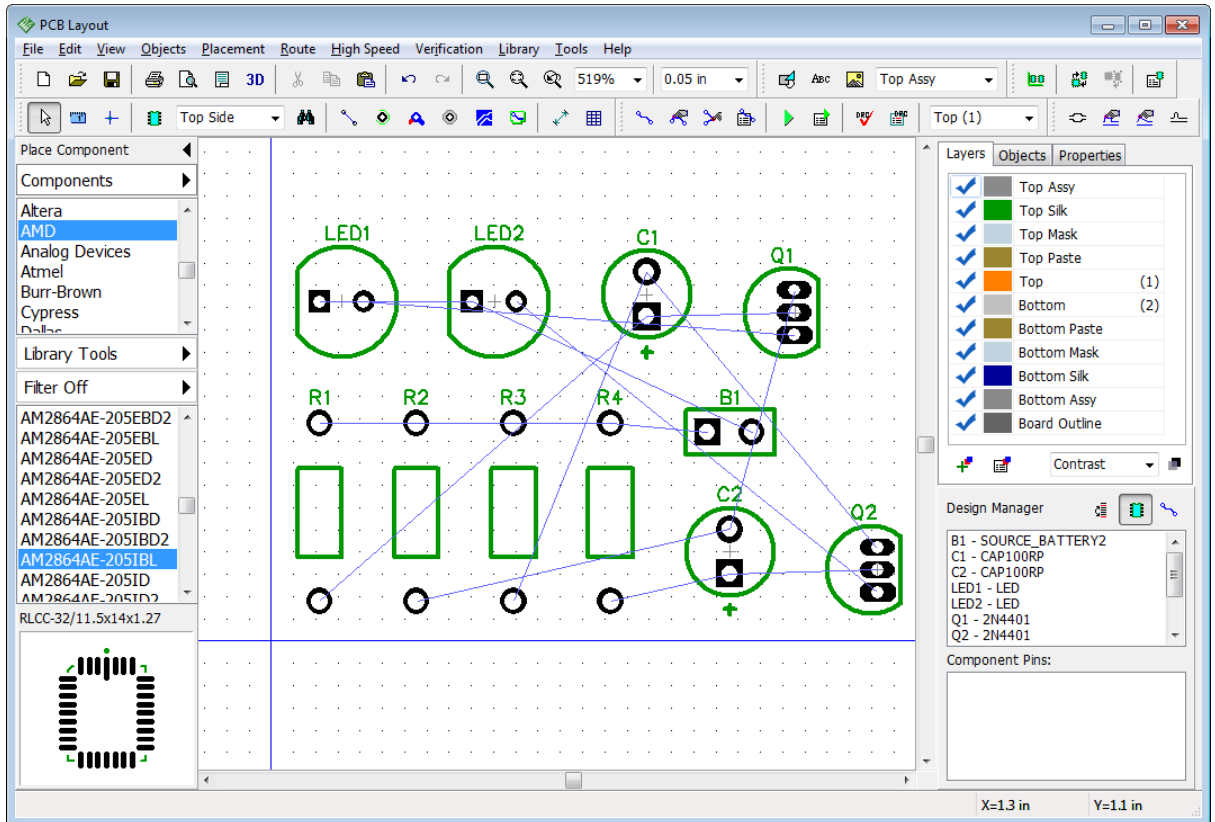

You can use Auto-placement or Placement by list features after converting to PCB. These are very convenient and useful tools which allow the user to get advantages of both automatic and manual placement modes. We will try to place components automatically in [Part III](#)<sup>(173)</sup> of this tutorial with more complex circuits.

### Component markings

Make sure that reference designators are visible. Select "View \ Component Markings \ Main \ RefDes" from the main menu, this command shows the reference designators of all components, except those with individual settings. If marking's text location doesn't look acceptable, you can justify it, select "View \ Component Markings \ Main \ Justify \ Auto" or select another mode. To increase the size of the marking text, select "View \ Component Markings \ Font \ 5pt" from the main menu. You can choose another size, but don't make it too big.

For the PCB Layout we recommend vector font for most of the time. Switch to TrueType, because **only TrueType fonts support Unicode and non-English characters**. Go to "View \ Component Markings \ Font \ <Font Type>" from the main menu. Vector and TrueType fonts look a bit different.

To define custom component marking parameters for selected components, right-click on one of them, select **Properties** from the submenu, then select the **Markings** tab in the pop-up dialog box. Remember that you can use the move tool – F10 or "View \ Component Markings \ Move Tool". This option allows for moving and rotating (90 degree step) any text object on the board.

### Manual placement

Now place components manually, according to your preferences and design rules. It is a good practice to keep power supply components in one area and functional blocks in another.

Apply appropriate layout rules and differential signaling for high frequency circuits. Notice that we use 0.05 inch (1.27 mm) grid, change it with a drop-down list on the Instruments toolbar. Select "View \ Units \ Inch" main menu item to change the measurement units or press *Shift+U*.

Create a layout similar to the picture below, with resistors at the top and LEDs at the bottom of the board. Drag and drop components to move them on the board. Press *Space* or *R* default hotkeys to rotate selected components 90 degrees. If you need to rotate to a different angle, select component, then right-click on one of them, and choose **Define Angle** or **Free Rotate** for precise and visual rotation respectively.

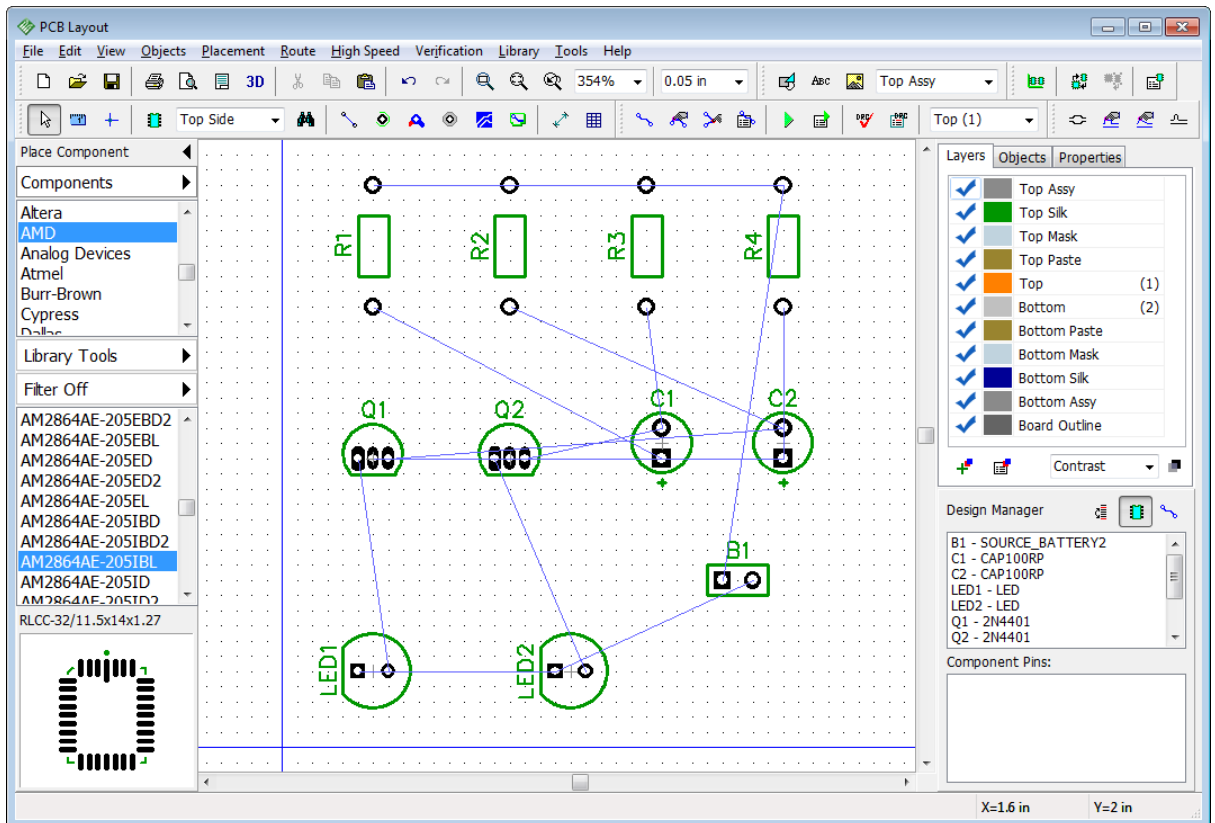

### Aligning objects

The project is simple, but you can use the **Align Objects** tool to align components in rows and columns automatically. For example, select four resistors (use the box selection or the *Ctrl* key to select multiple objects at a time), then right-click on one of them, and select **Align Objects** from the submenu. In the pop-up dialog box, set **Horizontal** direction, check the **Distribute Equally** and **Spacing** checkboxes and enter 0.35 inch in the **Spacing** field. The **Align By** section of this dialog box does not matter to us because we are aligning similar footprints.

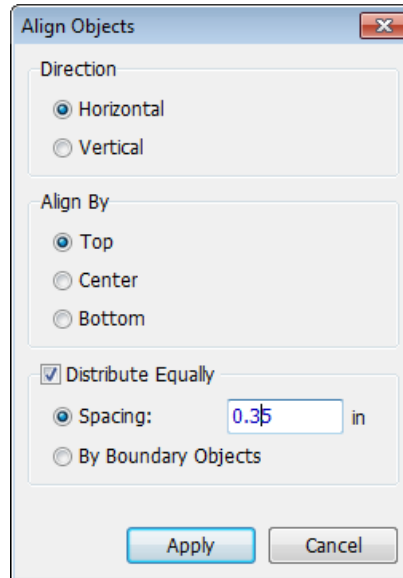



Press *F12* to optimize how connection lines visually appear on the screen (this does not change the net structure).

### Changing the net structure

We're going to practice in changing the net structure on the board, adding and removing connections. Blue thin lines between pads show logic connections, these lines are called "ratlines".

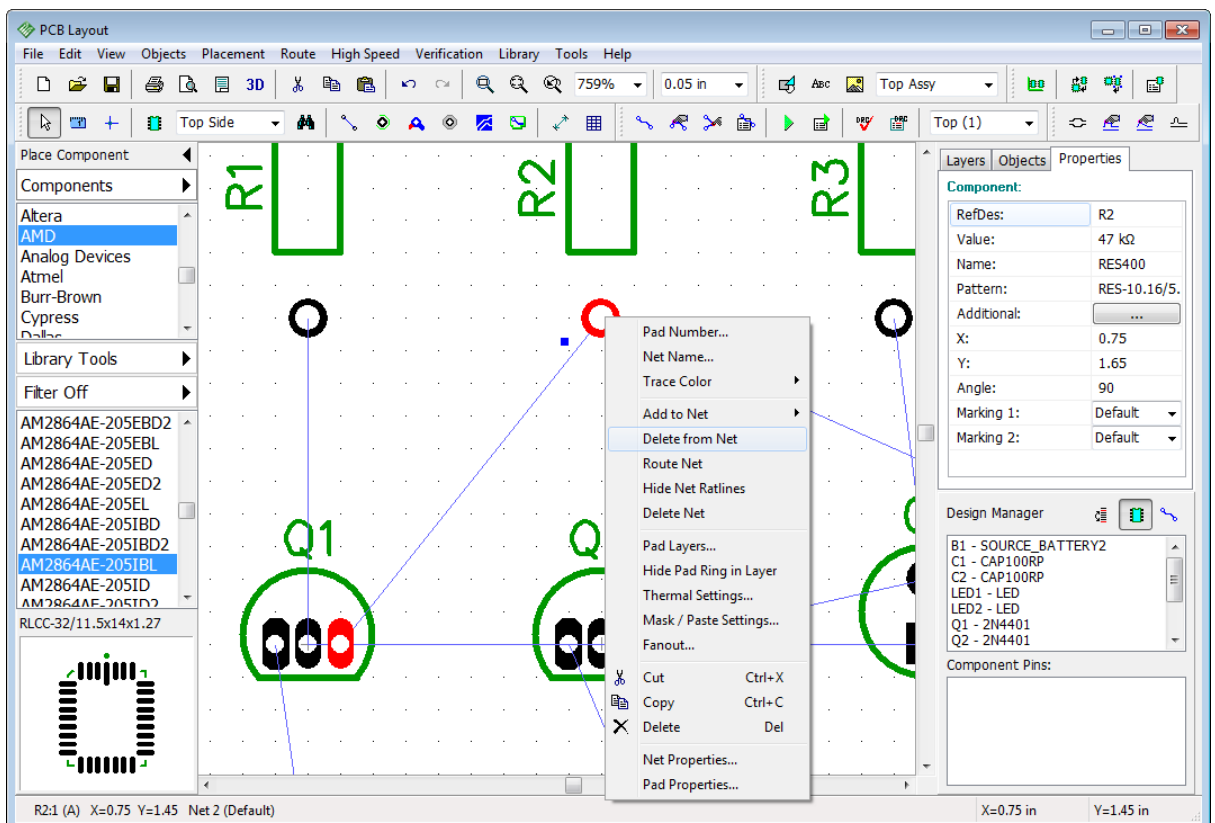
Hover over any pad with the mouse, right-click it, and select **Delete from Net**, the pad will disappear from the net. This pad is no longer connected with a blue line.



You can create a pad-to-pad connections visually. Select "Objects \ Place Ratline" from main menu or press  button on the objects toolbar. Then hover the mouse pointer over unconnected pad, left-click it, and move your mouse to any other pad (connected or unconnected), and left-click it. A new wire or a new net (in case if both pads were unconnected), represented as a thin blue line (ratline) will appear. To delete existing connection, just select **Delete Connection** from the right-click submenu on the pad.

If you would like to add selected pad to some net without creating a connection visually on the design area, hover over the pad with the mouse, right-click it, and select **Add to Net**, then select net from the list of all nets of the project or point it with the mouse cursor on the design area.

However, the most convenient way to add, delete or rename nets, as well as add or delete pads to/from the nets is the **Connection Manager**. Select "Route \ Connection Manager" from the main menu to launch it. Connection manager is easy and friendly.

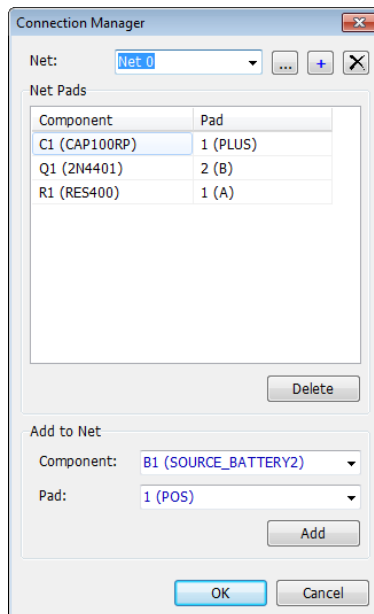

Select net from the **Net:** drop-down list and you will see all pads of the net in the table, you can delete them anytime. If you want to connect some pad to the net, select component and its pad, using the drop-down menus at the bottom of the dialog box, and press **Add** button.

If you have changed the net structure, please press **Undo** until previous design is restored. Close the connection manager. By the way, if you lose design or schematic because of incorrect exit from the program, use "File \ Recover Board" in the PCB Layout and "File \ Recover Schematic" in the Schematic to recover the latest project version.

To protect the net structure from accidental change, go to "Route \ Lock Net Structure" from the main menu.

## Board outline

We haven't determined the board outline yet. If you will launch the autorouter, it will create an appropriate rectangle board automatically but in real life electronic designer usually has certain board requirements well before starting the project. You can create relatively simple board polygon directly in the DipTrace or import it from the DXF file (if the shape is complex).

Select "Objects \ Place Board Outline" or press  button on the Routing toolbar, then place the board outline by left clicking the key points on the design area. Right-click on the final point of the polygon, and select **Enter** from the submenu or press *Enter* on the keyboard. For this design we require a simple rectangle board near 2 inches in size, see the picture below (notice that the origin point is hidden with *F1* hotkey).



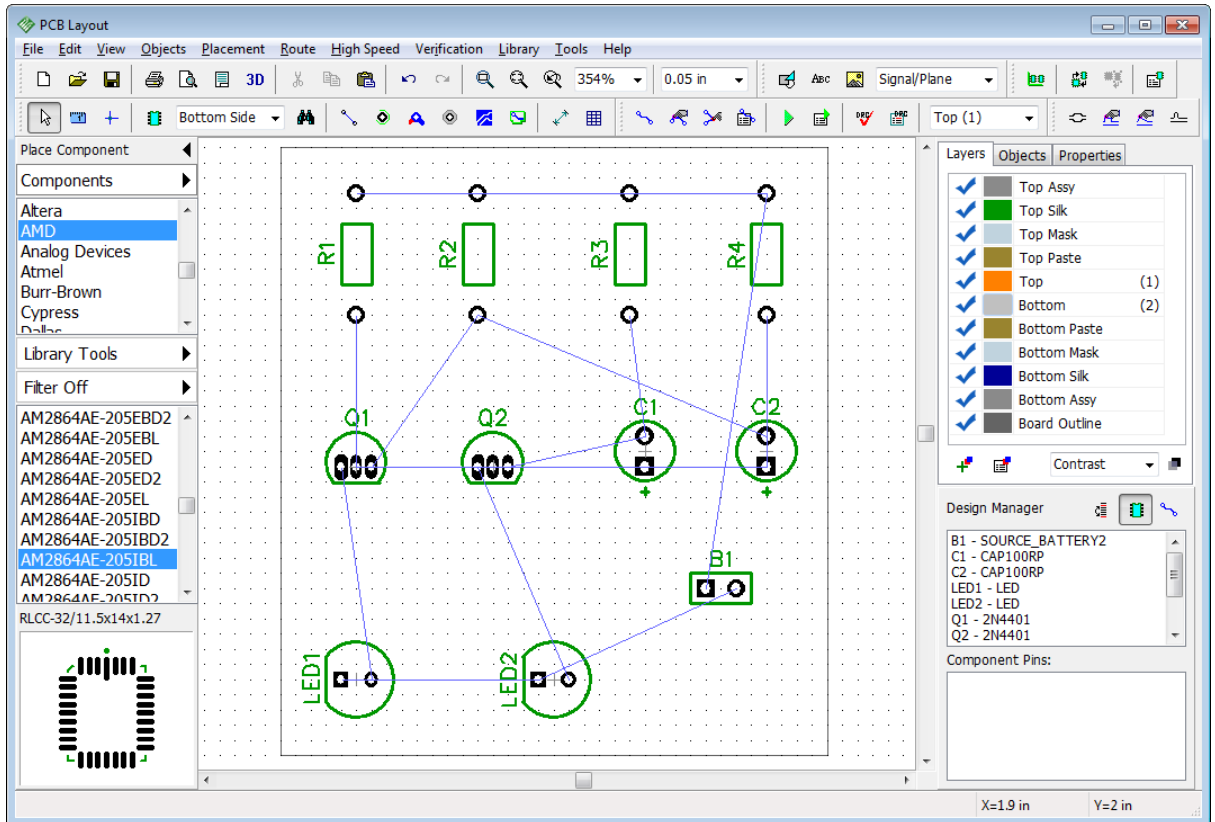

Notice that you can create arcs in the board outline by selecting **Arc Mode** from the right-click submenu while drawing the polygon.

You can insert new points into complete board outline polygon, or move each point or entire polygon on the design area. Point coordinates appear as a hint when cursor hovers over it.

There is another way to create board polygon that does not involve drawing it on the design area. Select "Objects \ Board Points" from the main menu.

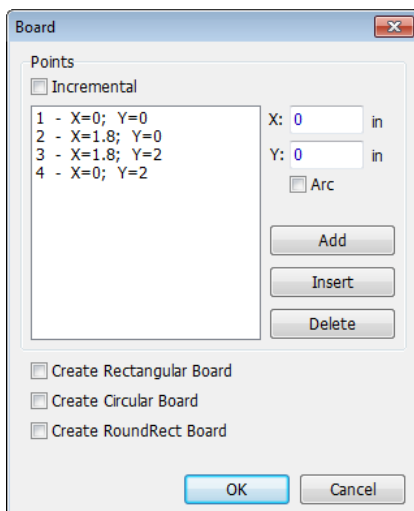

In this dialog box you can Add, Insert and Delete key points. Coordinates are shown and can be edited in absolute or incremental mode. If you check the **Arc** checkbox for some point, that point will become a middle point of an arc and the neighboring points will become the arc's first and end points. For rectangular boards, check **Create Rectangular Board** box and simply define the first point (base), width and height of the board. It is also possible to make circular and rectangle boards with rounded corners automatically.

Press **OK** to apply changes or **Cancel** to close the dialog box.

Notice that you can use "Objects \ Delete Board" from the main menu if you want to delete the outline polygon.

### Origin point

Correct board origin is important, because it is the reference point and beginning of the coordinates for the circuit board. Bottom-left corner of the board outline is the best place. If



you strictly followed the instructions given before in this tutorial, then you should see two blue lines crossing exactly there. However, in the case you do not see the origin point or it is not in the bottom-left corner of the board, select "View \ Origin" from the main menu or press *F1* hotkey to show it. If the position is wrong, go to "View \ Define Origin \ By Mouse Pointer" from

the main menu or press  button on the Instruments toolbar, and left-click on the design area (DipTrace helps to target on the key points).

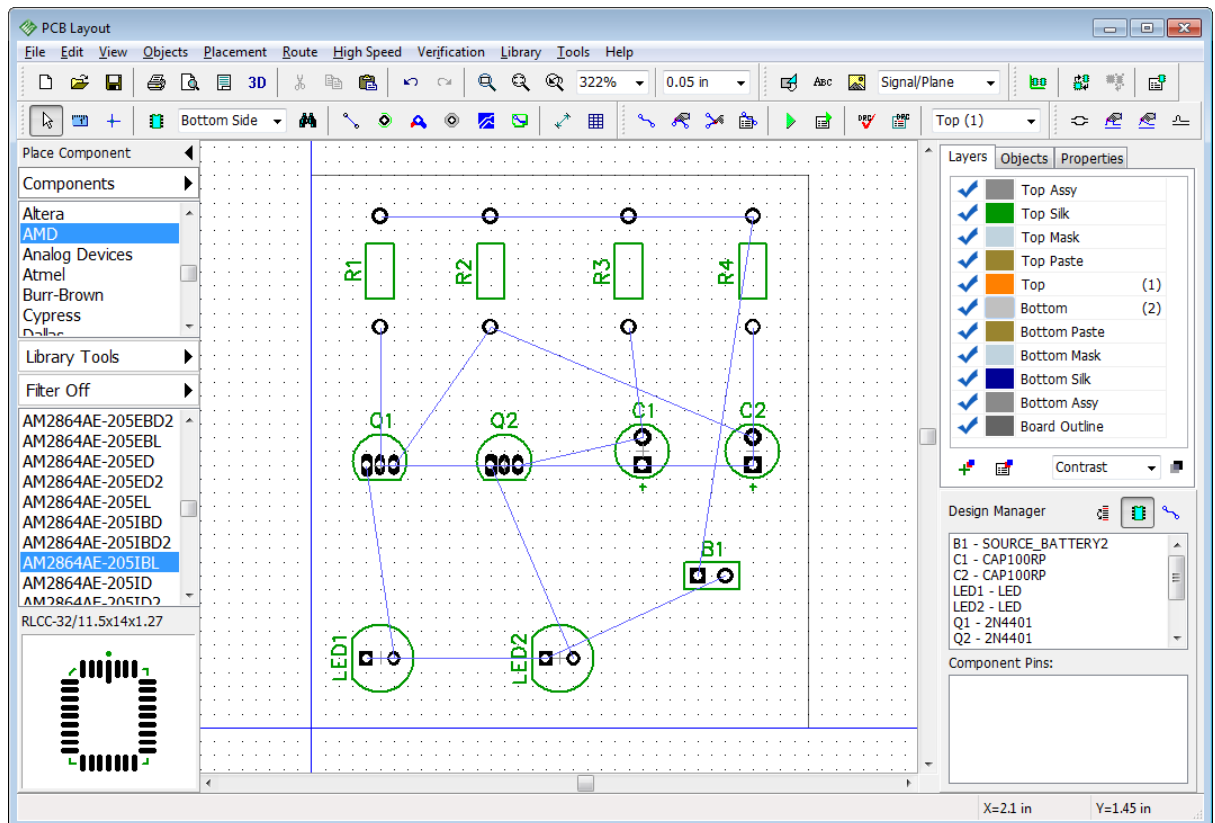

Now all coordinates in the PCB Layout will be displayed and edited relatively to the origin but you can change the origin's position at any moment.

*Notice that coordinates of components on the board are calculated by pattern's origin point. It is defined in the Pattern Editor. To show or hide an origin of selected component/s, right-click on one of them, and select **Pattern Origin** from the submenu.*

### Board cutout

DipTrace allows the designer to create board cutout polygons. You can create a cutout of any shape but in our case, we will create a simple rectangle cutout between LEDs and transistors just to show you how to do this.

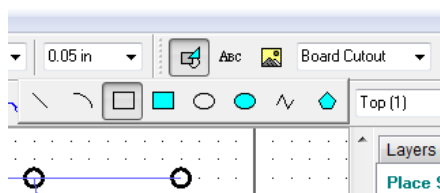

Select **Board Cutout** layer in the drop-down list on the drawing toolbar, then choose the rectangle drawing tool, and draw a rectangle cutout on the board on the design area. Pan, zoom and change the grid size for precise drawing. Board cutout is now ready.

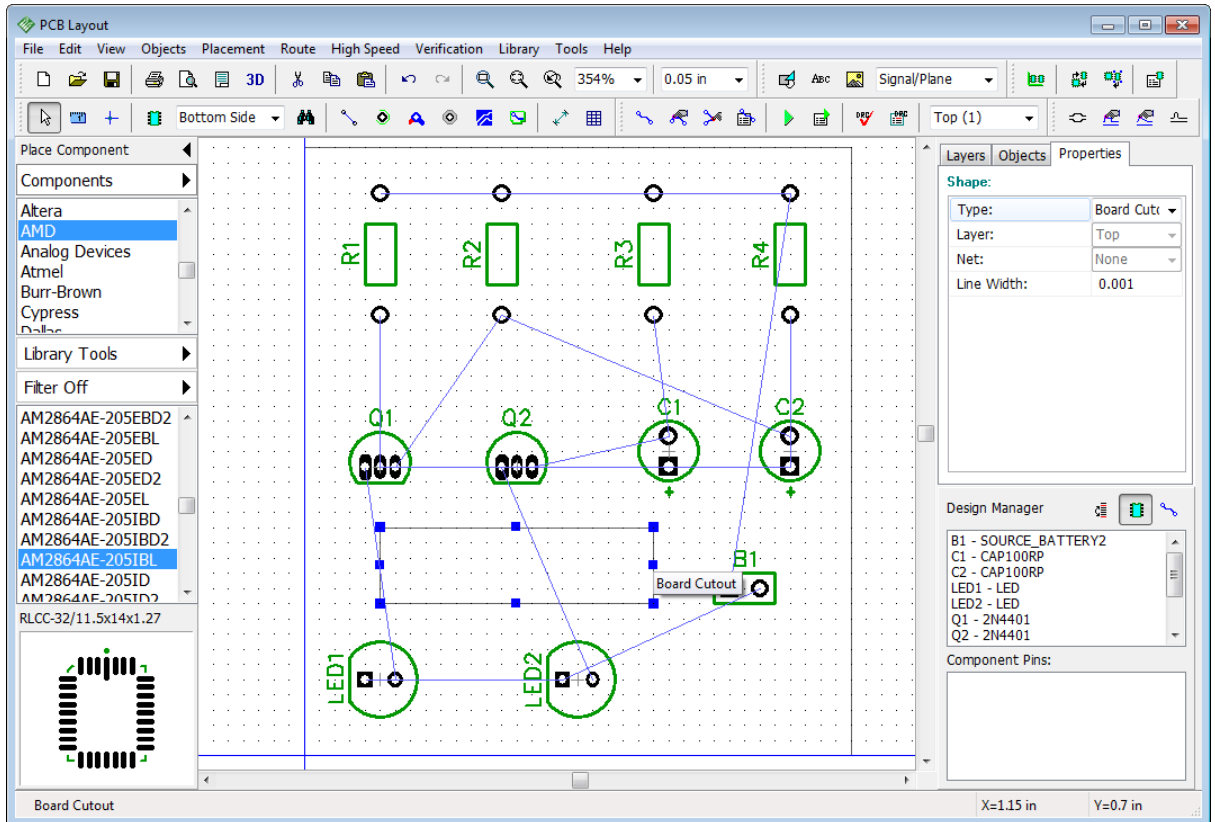

There is another way to create cutouts. Just draw a shape on **any** layer of the board or import it from the DXF file, then right-click on the shape, and select **Properties** from the submenu. In the pop-up dialog box, select **Board Cutout** from the **Type** drop-down list, and press **OK**.

*Notice that board cutout does not visually differ from the board outline, you should be careful not to place a cutout instead of an outline.*

### Route Keepout

Route keepout is an area on the board not intended for any copper. Autorouter does not draw traces there, and the program will report errors if you draw them manually. Board cutout shape does not have a clearance parameter like the board outline.

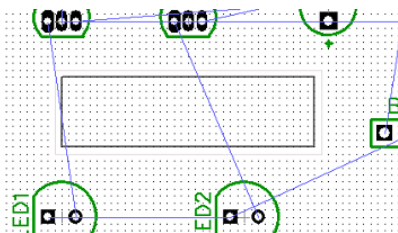

The route keepout around the board cutout will do the job. This allows for the clearance between the copper and the cutout. Since we plan to have copper traces only on the bottom layer, select the Bottom layer with 2 hotkey, then select **Route Keepout** layer in the drop-down list on the Drawing toolbar, and draw a shape on the Bottom layer. Create a rectangle which is a bit bigger than the cutout, like in the picture to the left. Change the grid size to 0.025 in for comfortable drawing. Then switch back to the top layer (press 1 hotkey).

## 2.3 Autorouting

Now it is time to route the printed circuit board. DipTrace has a high-quality shape-based autorouter and the Grid Router suitable for simple PCBs and single-layer boards with jumper

wires. Our project can be routed on a single layer (usually it is a bottom one). Single-layer boards usually have longer traces, but give many other benefits for prototyping. Longer traces do not affect the project this simple.

Select "Route \ Current Autorouter" from the main menu, and choose **Shape Router**, it's the best option for complex and simple designs (unless you need jumper wires). Go to "Route \ Autorouter Setup" from the main menu to set up the autorouter.

*Notice that autorouter settings depend on selected router (different panels for different autorouters).*

In the **Shape Router Setup** dialog box (which is selected now) go to the **Settings** tab, check **Use Priority Layer Directions** box, select **Top** in the list of layers, and set **Off** in the **Direction:** drop-down list below. This means that autorouter will not create any traces on the Top layer.

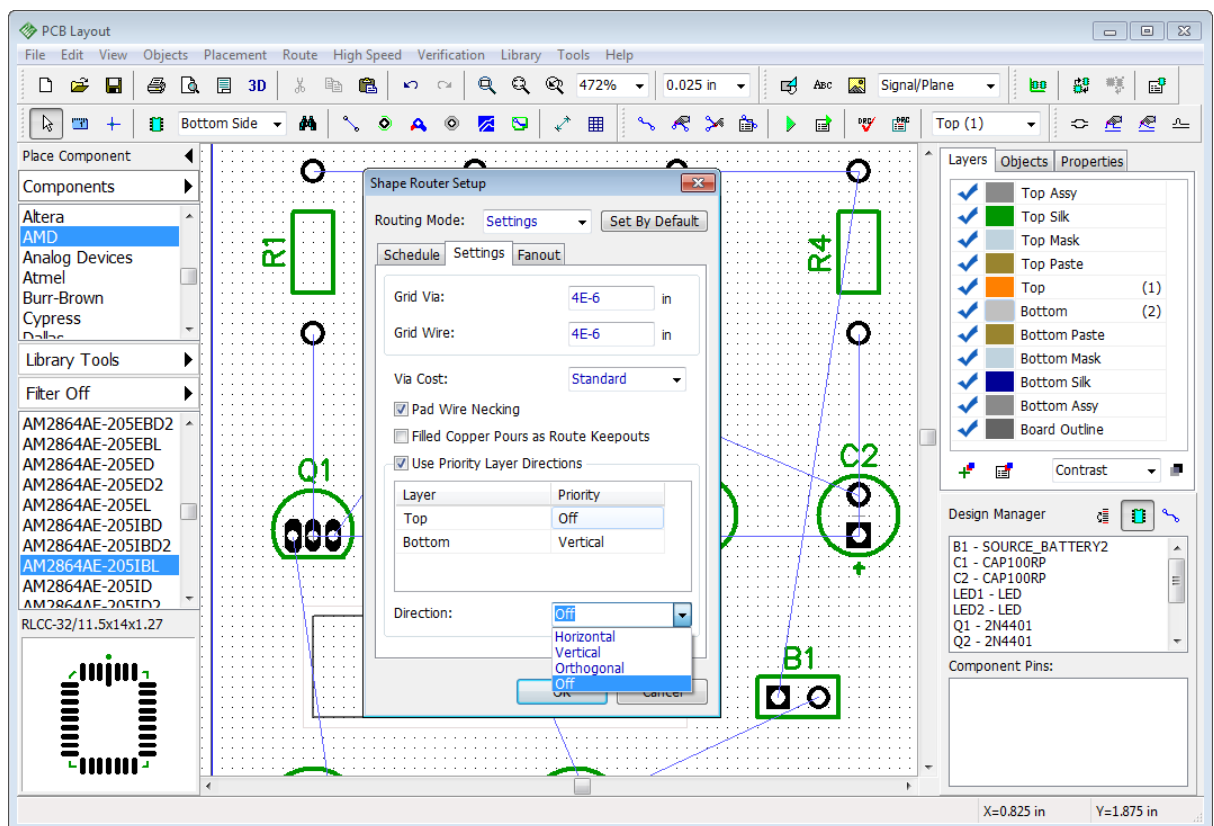

If you want to route the board with jumper wires you need to select the Grid Router, and check **Allow Jumper Wires** box in the **Autorouter Setup** dialog box. In our case, we don't need that. Press **OK** to apply changes. Then select "Route \ Route Setup" from the main menu. In the pop-up dialog box, you can change the trace width and clearance between traces for **default** net class and the diameter of vias for **default** via style. **Route Setup** dialog box is the quickest way to change these parameters, but more complex projects would require using several net classes and via styles. You can press **All Classes...** and **All Styles...** buttons to access the respective dialogs. We will discuss [Net Classes](#)<sup>[47]</sup> and [Via Styles](#)<sup>[44]</sup> later in this tutorial.

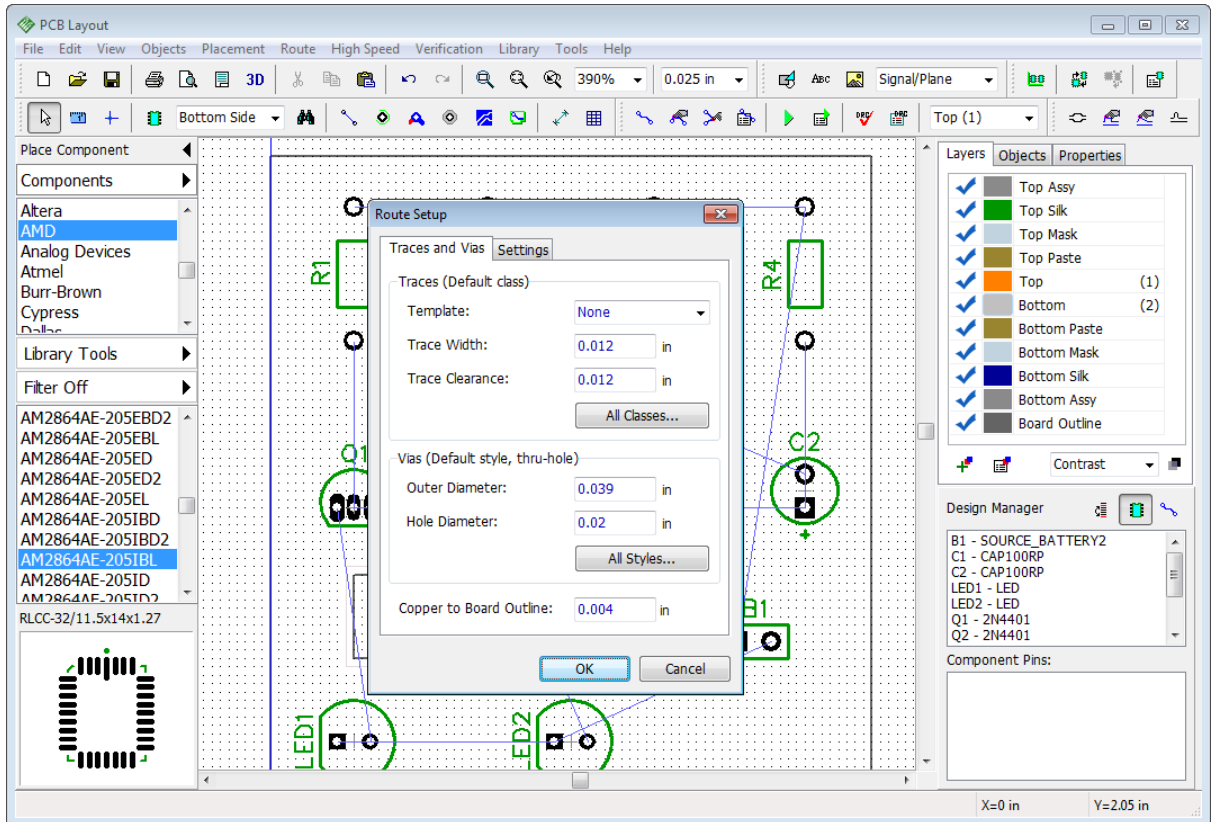

If you are new to DipTrace, we strongly recommend you to use the settings like in the picture above for this tutorial project, it will help to avoid any misunderstandings and errors later. Press **OK** to close this dialog box and apply changes, then change the grid size back to 0.05 inch.

Now it's time to route the circuit board. Select "Route \ Run Autorouter" from the main menu. You'll get something like in the picture below. Your layout doesn't have to be exactly like the one shown, so don't be confused if you are new to PCB design and some traces doesn't coincide with the picture.

*Notice that color of the traces depends on the layer color. We will change it in the next topic of this tutorial.*

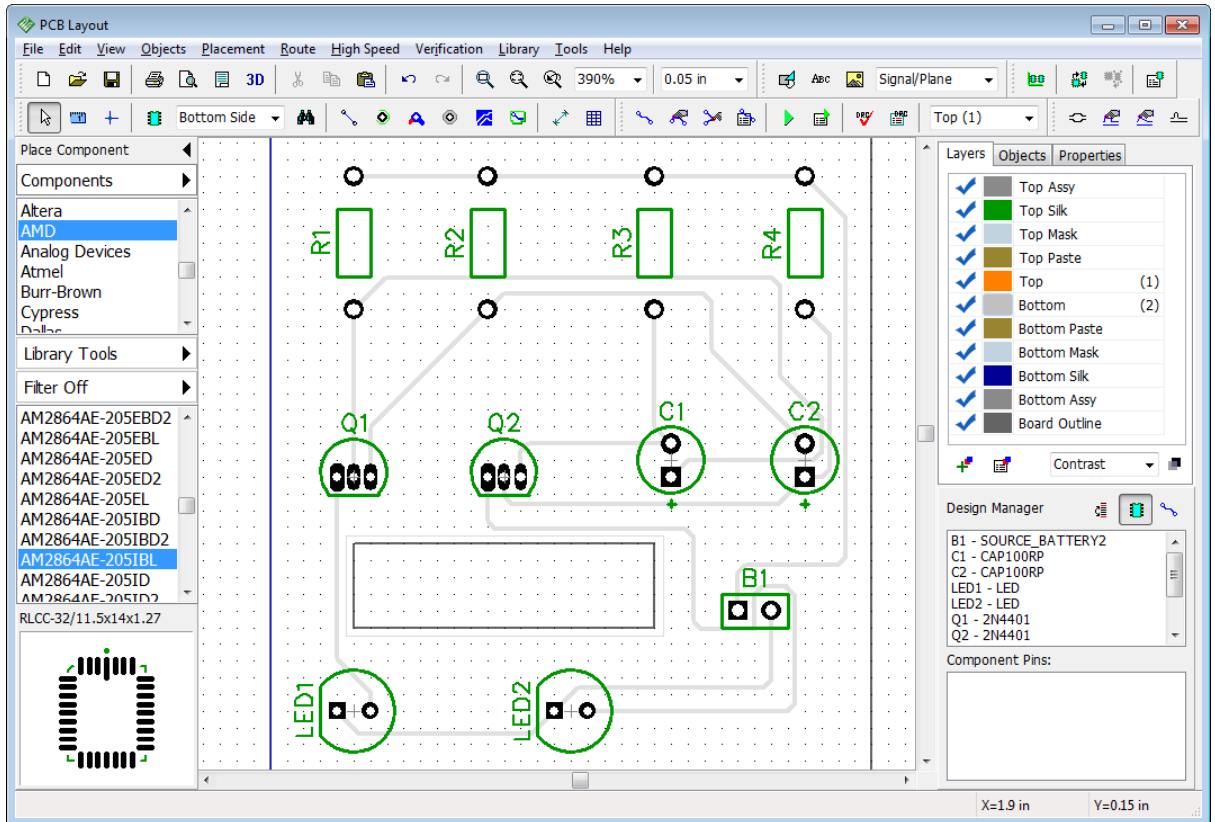

### Automatic DRC

DipTrace has several verification options on different levels of PCB design. For example, Design Rule Check (DRC). It verifies object sizes, length/phase parameters of high-speed nets, and clearances between different objects according to user-defined rules. The DRC results in the error-report list. Violations are marked with red and magenta circles directly on the design area. Design Rule Check in DipTrace operates in regular (offline) and Real-Time modes. If Real-Time DRC is active, you've probably noticed some red circles while moving components and creating traces. But it should be OFF by default, therefore we will discuss verification procedures later.

Regular or Offline DRC (Design Rule Check) runs automatically after autorouting. This project is very simple and you shouldn't get any errors, if there are some, make corrections and relaunch the DRC by selecting "Verification \ Check Design Rules" from the main menu

or press  button on the instruments toolbar. To change design rules, select "Verification \ Design Rules" from the main menu. To hide error circles on the design area, select "Verification \ Hide Errors". To disable automatic DRC after autorouting, uncheck the corresponding checkbox in the "Route \ Current Autorouter" main menu item.

Select "File \ Save" from the main menu, in the pop-up dialog box define the folder, type in the name of the file and press **Save**.

*Notice that now you can skip all topics till the [Printing](#)<sup>[81]</sup>, because your PCB is actually ready to output, but if you want to learn some basic useful features of the DipTrace PCB Layout, we don't recommend to skip those.*

## 2.4 Working with layers

The traces are in lower contrast, because they are on the Bottom layer of the board, while the Top layer is active. We can see those traces because the Contrast layer display mode and 50% opacity between the layers are default settings.

Look at the **Layers** tab on the **Design Manager** (press *Ctrl+3* hotkeys if the Design Manager panel is hidden). If you want to switch to another layer, double click it in the list or press the corresponding hotkey (they are noted in the brackets next to the name of each layer), or you can use *T* and *B* keyboard keys for top and bottom layers respectively. You can also change active layer in the list box near the DRC control buttons.

We double click the Bottom layer in the list to activate it. Make sure you click on the layer name (text) in the list, not on the blue check mark or elsewhere. Grey color is quite dim itself, click on the colored rectangle right next to the Bottom layer and select the red color in the pop-up dialog box. Press **OK** to change the bottom's layer color to red.

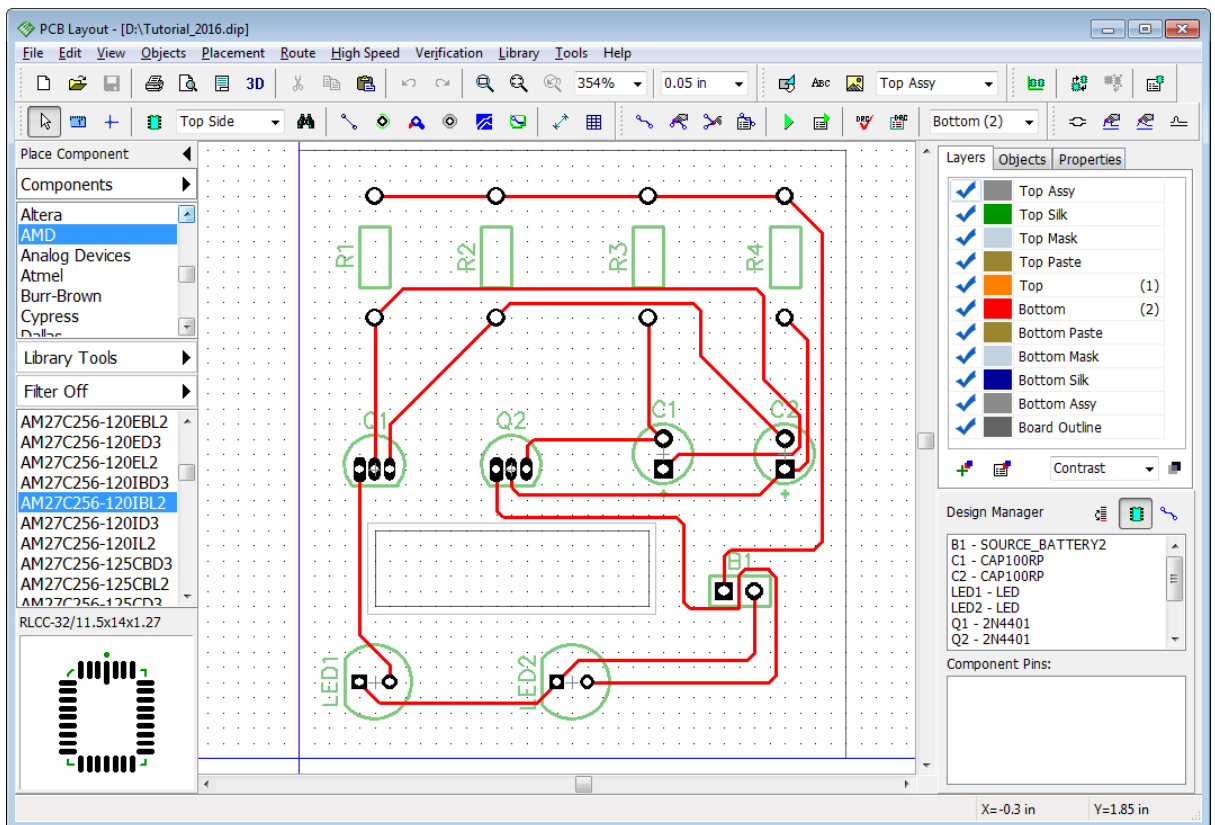

All layers are divided into two basic types: Signal layers and Non-Signal layers. DipTrace user can easily add, delete, and edit both. Our project is a simple circuit board with two signal layers: Top and Bottom. But as you can see in the list, there are much more of them. Assy, Silk, Paste, Mask are non-signal layers. DipTrace creates them automatically on both sides of the board (and gives corresponding names to each of them depending on their side of the circuit board - Top Silk, Bottom Paste etc.). Each layer carries a special type of information.

Top/Bottom Silk are silkscreen layers, all texts and graphical information are automatically added there. Top/Bottom Mask and Paste layers carry information about solder mask and solder paste application zones. Some non-signal layers are necessary for correct board manufacturing, others provide additional functionality, for example, when drilling PCBs at home. More information about each layer in the [Gerber Output](#)<sup>[84]</sup> topic of this tutorial.

## Signal layers

Traces and copper pours can be created only on signal layers. There are two types of signal layers: Signal and Plane. Signal layers usually contain traces and sometimes copper pours, while Plane layers are inner (inside the board), they contain one or several copper pours. Autorouter can create traces only on signal layers.

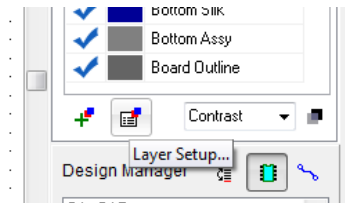

If you want to add, edit, create or delete layer, go to "Route \

Layer Setup" or press  button on the **Layers** tab on the **Design Manager**. In the **Signal / Plane** tab of the pop-up dialog box, you can specify the name, type, color etc. of each signal or plane layer. Notice that you can't change some parameters for certain layers.

We will add a new plane layer called "Tutorial Layer" just to show you how it works. Press **Add** button in the **Layers** dialog box, then enter the layer name, select type and color. Press **OK** to create a new layer, now it appears in the list. Plane layers can be connected to one of the nets, usually it is Ground or Power, in our case it is unconnected. You can also define a single size for all pad rings on the layer. All pads on inner layers are round no matter what.

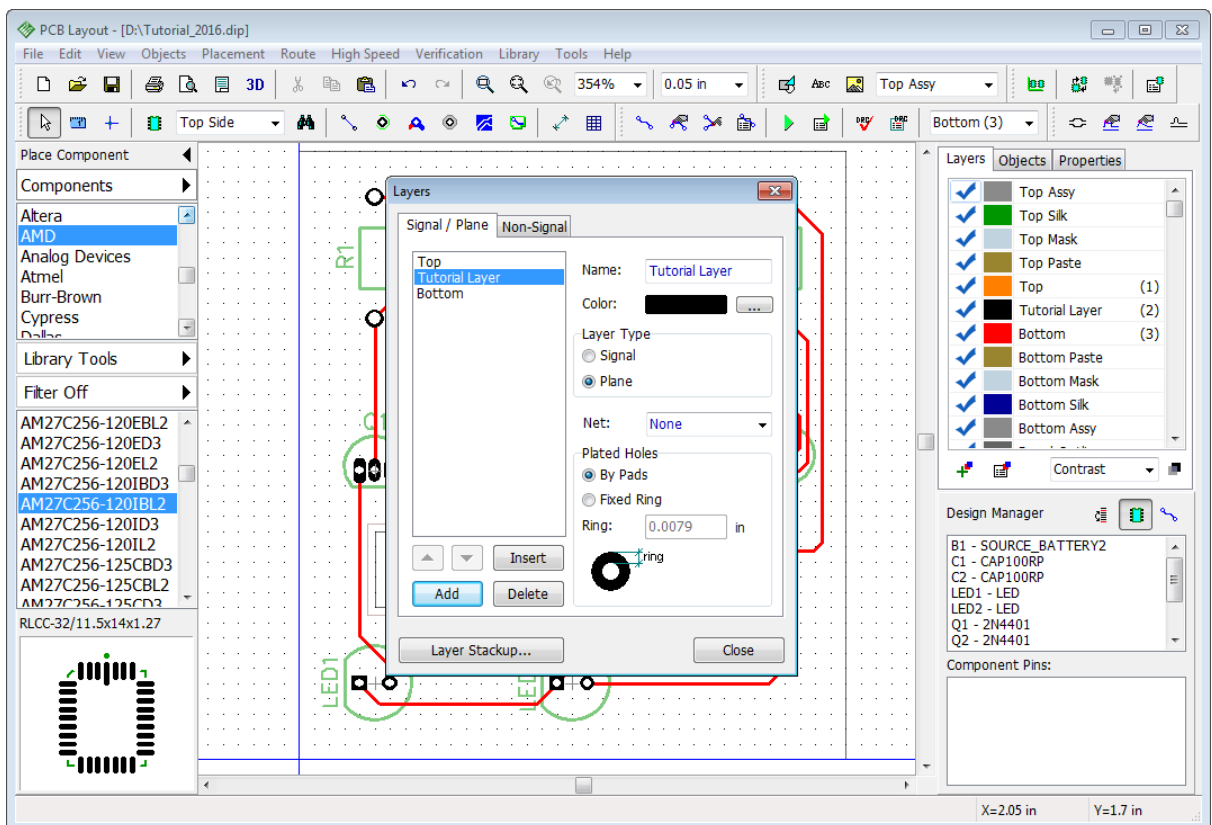

Press the **Close** button to close the **Layers** dialog box, as you can see the Tutorial Layer is already on the layers panel, between Top and Bottom layers.

Create one more **plane** layer, because circuit boards should always have even number of layers. Right-click it in the list on the Tutorial Layer, and select **Insert Layer**, in the pop-up dialog add new plane layer. Now when you right-click on the plane layer in the list you can move it, select **Move up** or **Move down** in the submenu to change the board stack. Click on the color rectangle to quickly change the color of the corresponding layer.



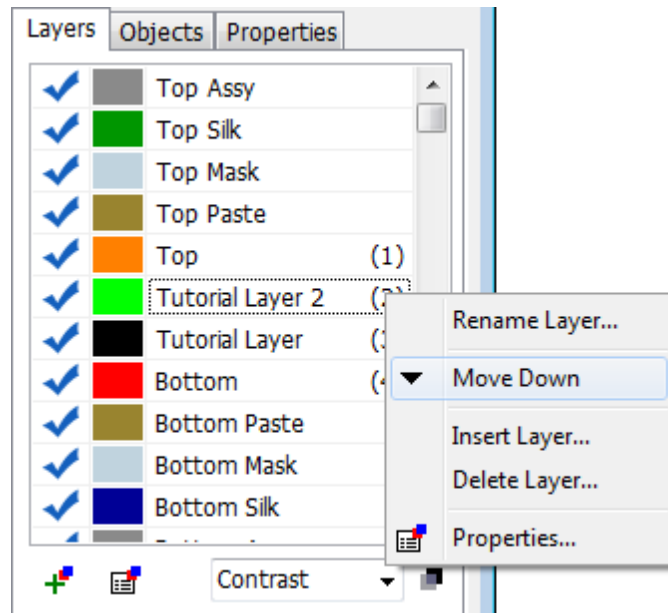



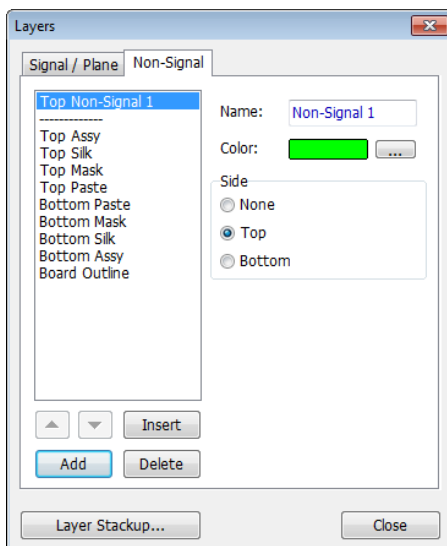

### Non-Signal layers

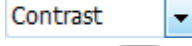

Customizable non-signal layers used for various engineering purposes. They improve speed and total convenience of electronic design in DipTrace. If you need to create a non-signal layer, select the **Non-Signal** tab in the **Layers** dialog box ("Route \ Layer Setup" from the main menu), then press the **Add** button, enter layer name, select color and layer side: None, Top or Bottom. None means that layer will not be locked to some specific side of the board.

We do not need any custom non-signal layers. Close this dialog box.

There are some quick-access buttons on the **Layers** tab of the **Design Manager**:  – Add Layer,  – Layer Setup,  – layer display mode, and contrast level setup – .

Remember to use 1,2,3,4 hotkeys to quickly change an active layer.

Notice that in DipTrace you see the bottom layer of the circuit board like if it was transparent. Pick "View \ Mirror" from the main menu to mirror entire circuit board. Now you see how the bottom layer actually looks like. However, this is not necessary, because Gerber Export automatically creates the correct copper layout on the bottom layer.

Delete non-signal layer if you have created one, we don't need them for this project. But do not delete custom plane layers, we'll use them later for practicing with vias. Save the design.

## 2.5 Working with vias

DipTrace supports through and blind/buried vias (if divided by physical properties). Vias are also divided by two logical types that don't depend on their physical properties:



**Trace Vias** (regular vias), which are technically parts of the traces and appear automatically when you move trace segment to another layer;

**Static Vias** (similar to pads), which are placed manually, they have much more variable properties than trace vias.

*All vias in the DipTrace, disregarding their logical type, are organized to Via Styles.*

We don't need a lot of different via styles for the current project, but we will add some in order to teach you the basic principles of working with vias.

Let's create two additional via styles: one with blind/buried vias of the same size as the Default via style (0.039 inch-diameter and 0.02-inch hole), and the other via style for through vias of bigger diameter. Go to "Route \ Via styles" and check if Default via style has aforementioned parameters. Change them if you need. Then press **Add** button to add a new via style. It will appear under the Default one. Left-click it, and type in the name, change via type to **Blind/Buried**, and specify the layers involved (top and bottom layer of the via). In our case, we make blind vias from Top layer to Tutorial Layer. Specify via properties like in the picture below. Blind vias are impossible on printed circuit boards with only two layers, that is why we did not delete tutorial layers from the previous topic of this tutorial.

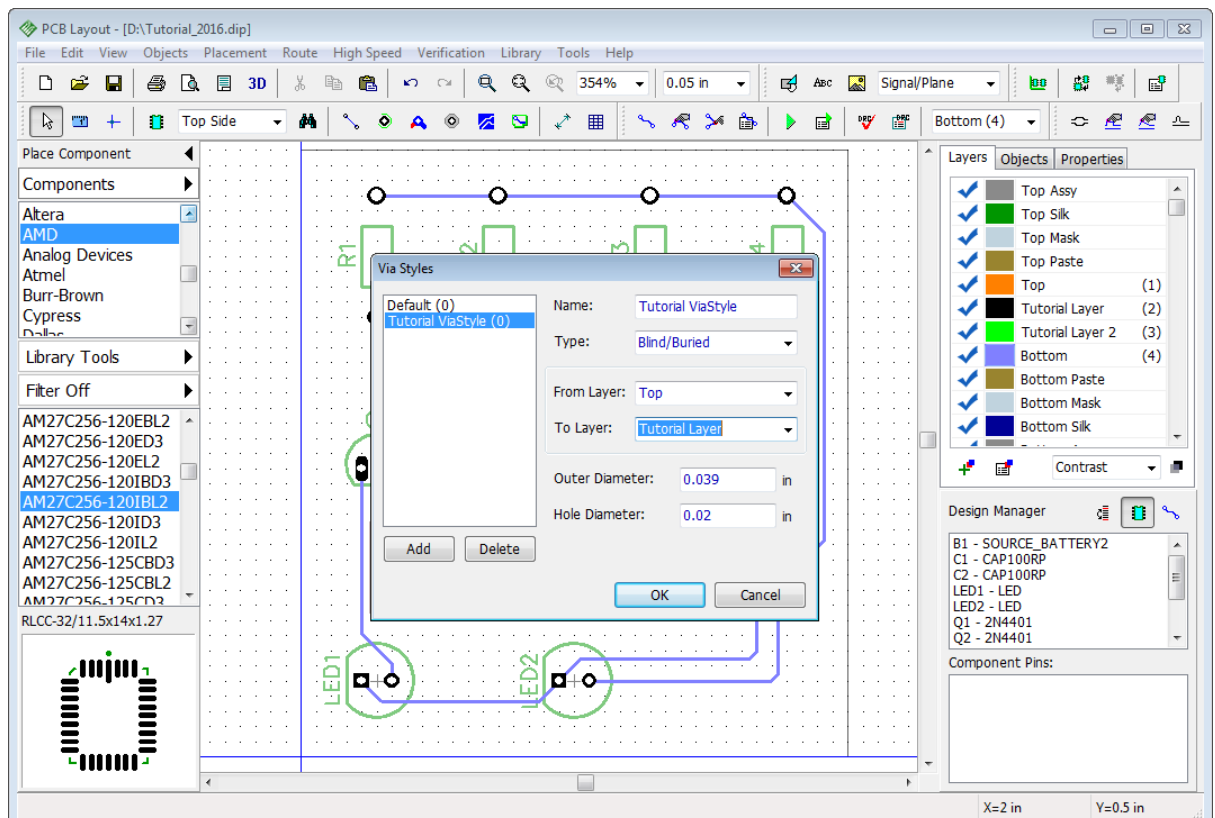

Now add one more through via style called "2 Tutorial ViaStyle", and enter 0.065 inch outer and 0.03 inch hole diameters. Press **OK**.

Notice that we've changed the bottom layer color to violet.

### Trace vias

Now unroute one of the nets (we will route it manually). We have chosen the net that connects resistors' pads with a battery.

Switch to the Bottom layer, then right-click on the net that you want to unroute, and select

**Unroute Net** from the submenu. Go to "Route \ Manual routing \ Add Trace" from the main menu or press the *Tilde Sign (~)* hotkey. Left-click on the first pad (R1:2), then on the second pad (R2:2) to create a trace. Now left-click on the R2:2 again, but do not create a trace all the way to R3 resistor. Just route it to some point between the R2 and R3, left-click to set a trace segment between the pads, then right-click, and select "**Segment Layer \ Top**" from the drop-down submenu (if you're routing on the bottom layer and vice versa). Trace via will appear automatically, now we can continue routing on the opposite side of the board to another pad, and then left-click it. Create one more segment between the R3 and R4 components. Notice that trace color is defined by the layer color. Do not route entire net all the way to the battery.

Start creating the trace heading from the R4 resistor. Select **2 Tutorial ViaStyle** from the **Via Style** drop-down on the **Manual Routing** panel on the **Design Manager** to apply selected via style to the vias being created. Auto means that DipTrace will use a via style that takes less space on the board, but in our case, we select the style with bigger vias (2 Tutorial Via Style). Now create a trace via (go to the opposite board side) and finish the trace to the B1 component.

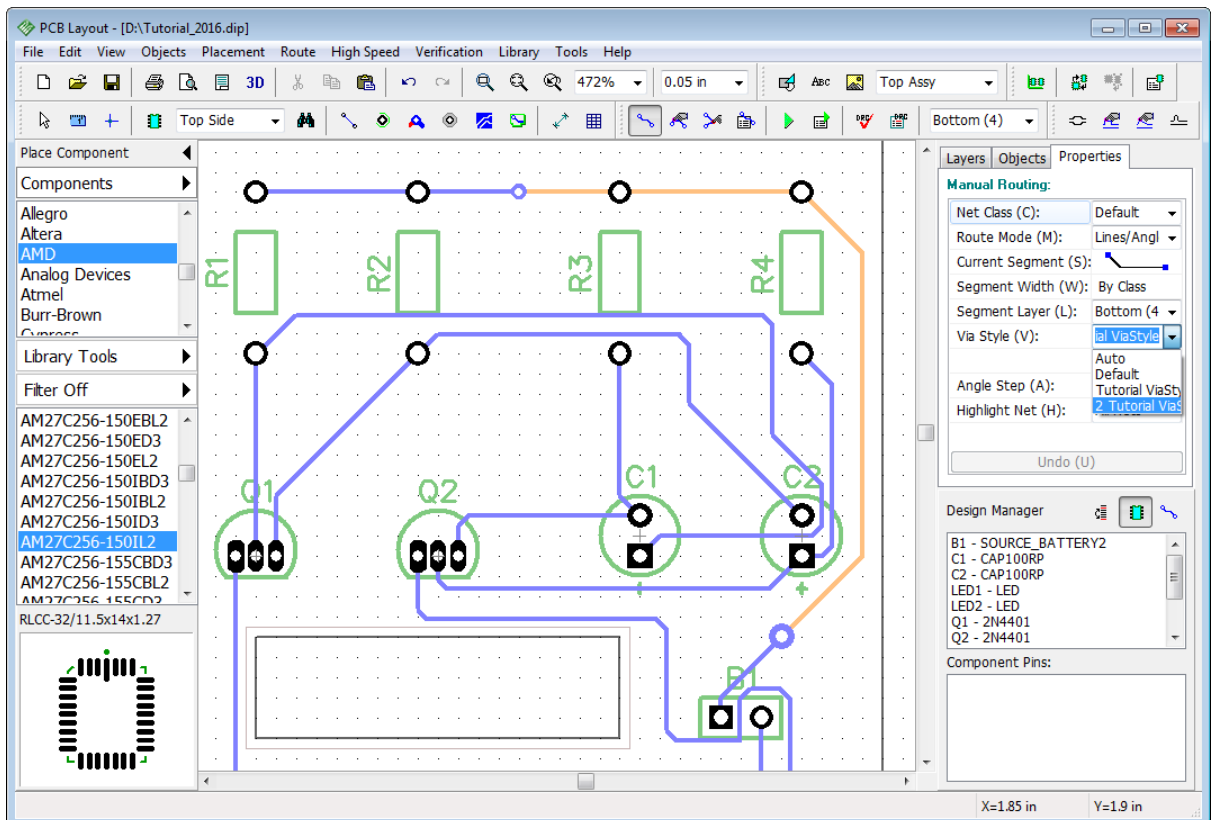

### Static vias

Press  button to place a new static via on the design area or you can make it directly from the trace via, just right-click on it, and select **Convert Via to Static**. Then specify which vias to convert: Current via, Selected segments etc. Static vias behave almost like pads.

*If you change the parameters of some via style, all vias of that style, even those on the design area, will change automatically.*

We can change style, type, diameter of the static via and apply new settings to current or selected vias or nets in the Via Properties dialog box. Right-click on one or several vias, and

select **Via Properties** from the submenu, make some changes, and press **OK**. If there is no via style with the parameters you've entered, DipTrace will ask if you want to create a new via style.

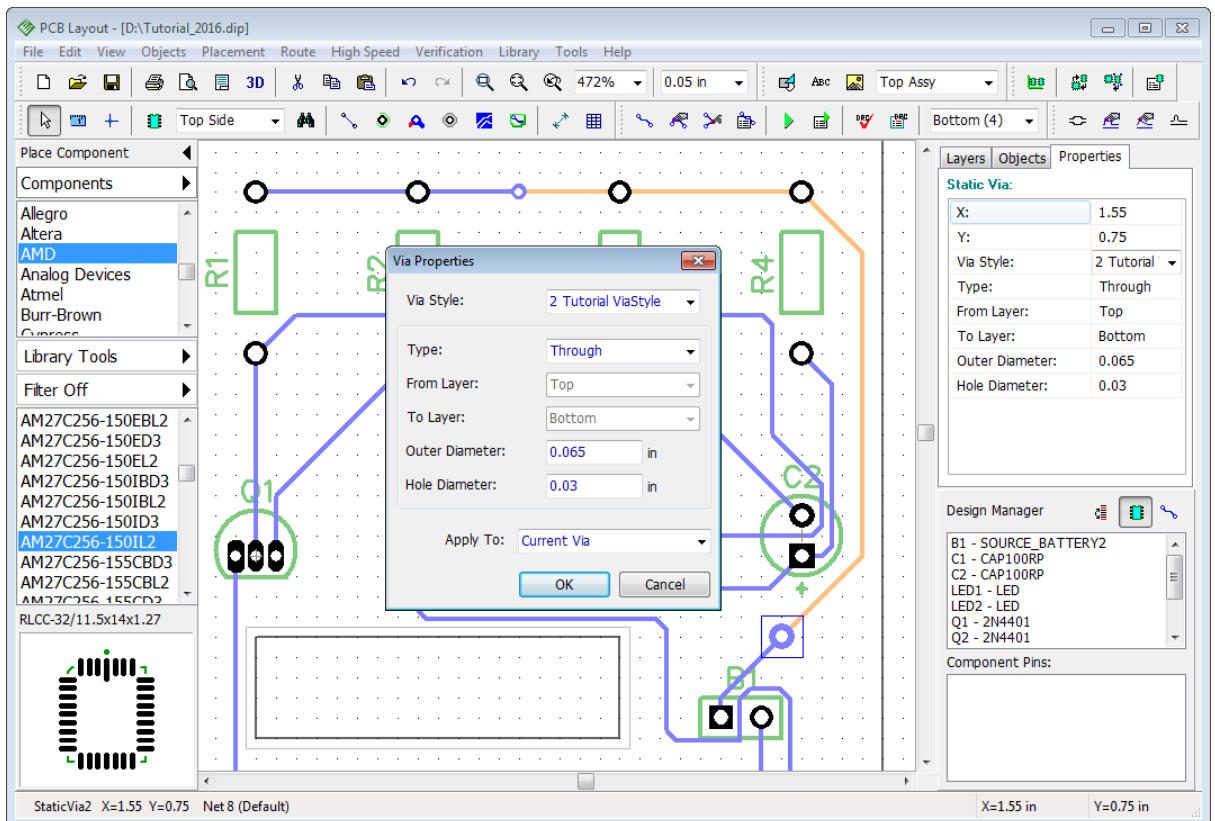

You can convert static vias back to trace vias, right-click on the static via, and select **Convert to Trace Via** from the submenu, and select which vias to convert. If you've placed a static via directly on the design area, you can not convert it back to trace via.

Delete all vias and route the trace on a single layer, but do not use the **Undo** tool, because this will delete custom via styles.

## 2.6 Net classes

All nets in DipTrace are organized to Net classes. Net classes allow the user to apply numerous parameters to any net with one click. Net classes work with manual and automatic routing (Autorouters). Specify net class parameters **before** routing nets.

We are going to practice in working with net classes using the same project, therefore, we need to completely unroute it first. Go to "Route \ Unroute All" from the main menu. Then select "Route \ Net Classes" from the main menu to open the **Net Classes** dialog box. You can see that only the Default net class is available and all nets belong to this class. Press **Add** button and a new net class appears in the list of all net classes, right under the Default. Left-click it, and type in the name.

In the **Class Properties** tab, specify trace parameters and clearance value. In our case, we will make traces of a new net class significantly larger (0.03 in) with 0.05 clearance.

*Notice that Star symbol (\*) in the input field means that it is a default value.*

If you uncheck **All Layers**, the list under this checkbox becomes active, allowing different

trace parameters on different layers of the board. We don't need this now.

Uncheck **Use All Styles** checkbox in the **Via Styles** section, and choose which via styles you want to use with this net class. Just press << and >> buttons to add or delete via styles to/from the list of active. The  button allows the user to preview parameters of each via style. We have allowed only custom via styles for this net class (see the picture below).

New net class exists, but it does not have any sense if no nets belong to it. So we're going to add nets. In the lower-right of the **Net Classes** dialog box, you can see the list of all project nets and the name of the current net class of each net in the brackets. In our case, it is Default net class. Select one or several nets with *Ctrl* key, and press the  button to add them to the net class (**Class Nets** list right above).

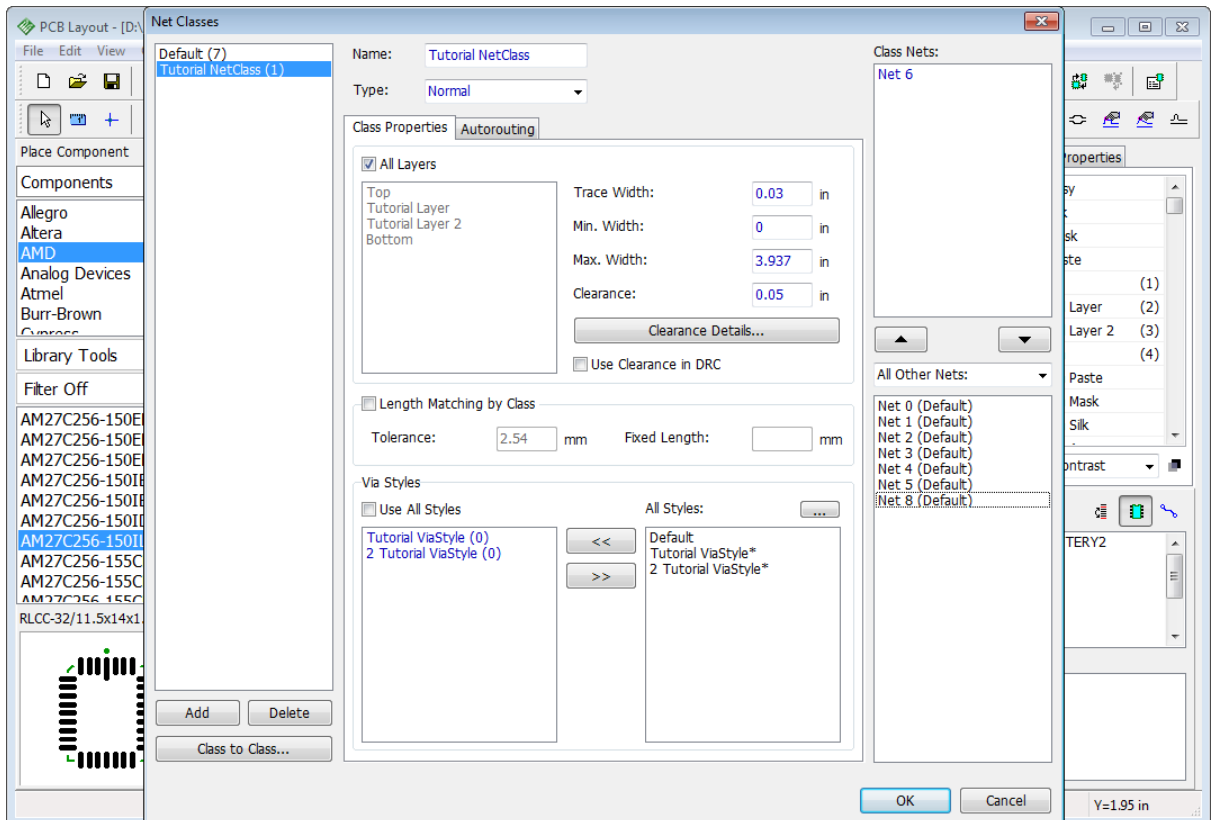

As you can see, the Tutorial NetClass contains one net (Net 6 in our case) with .03 inch trace width.

The **Clearance Details** button allows you to set different clearances depending on the type of the objects. Press **Class to Class...** to specify clearance between the nets of different net classes. Class to class clearance is used by DRC and has priority over regular net class clearances. Make sure **Use Clearance in DRC** item is unchecked, and press **OK** to close the Net Classes dialog box and save changes.

### Autorouting with net classes

Now you have two different net classes, one net belongs to Tutorial Net Class and the rest – to Default. It's time to route the board with autorouter, select "Route \ Run Autorouter" from the main menu or press *Ctrl+F9* hotkeys and you'll get something like in the picture below. As

you can see, the traces on the PCB have different width, because they belong to different net classes with different parameters.

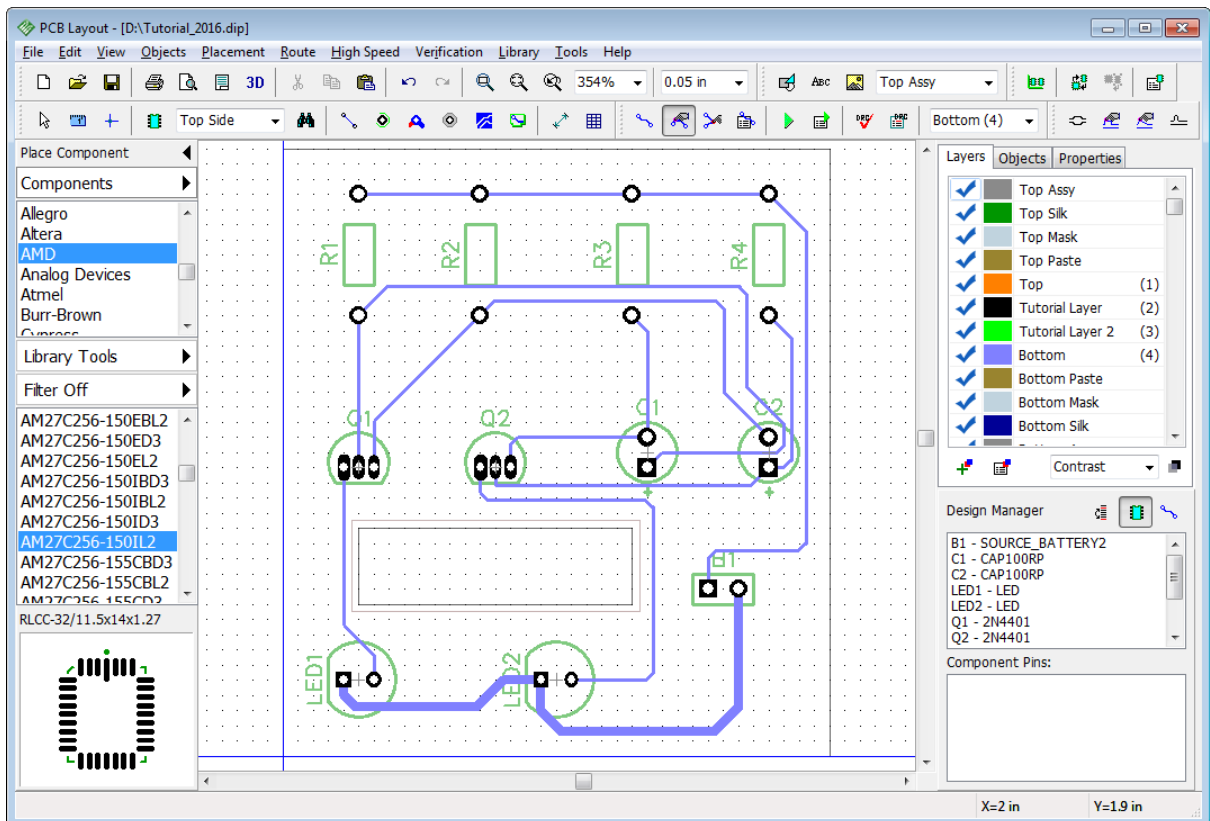

If everything is clear, unroute the board again ("Route \ Unroute All"), open the **Net Classes** dialog box and reassign Net 6 from Tutorial NetClass to Default class (use the  button). Press **OK**, then launch autorouter again and you'll get the circuit board with all traces of the same width. Tutorial NetClass still exists, but it doesn't do anything because no nets belong to it.

### Manual routing with net classes

Select the Bottom layer, and left-click on one of the nets (for example, Net 8 between the resistors and a battery), you'll see the **Net Properties** panel on the Design Manager to your right-hand side. In the Net Class drop-down list select Tutorial Net Class. Then right-click on the same net and select **Unroute Net** from the submenu. Now press the *Tilde Sign* (~) hotkey to activate manual routing mode, left-click on the first pad (R1:2), and create a trace to another pad (R2:2), and left-click it to create a trace segment. You'll notice that the trace is much wider because it is in another net class.

*Notice that DipTrace allows for changing the net class of the routed net, but in order to apply changes, the net has to be unrouted and routed again.*

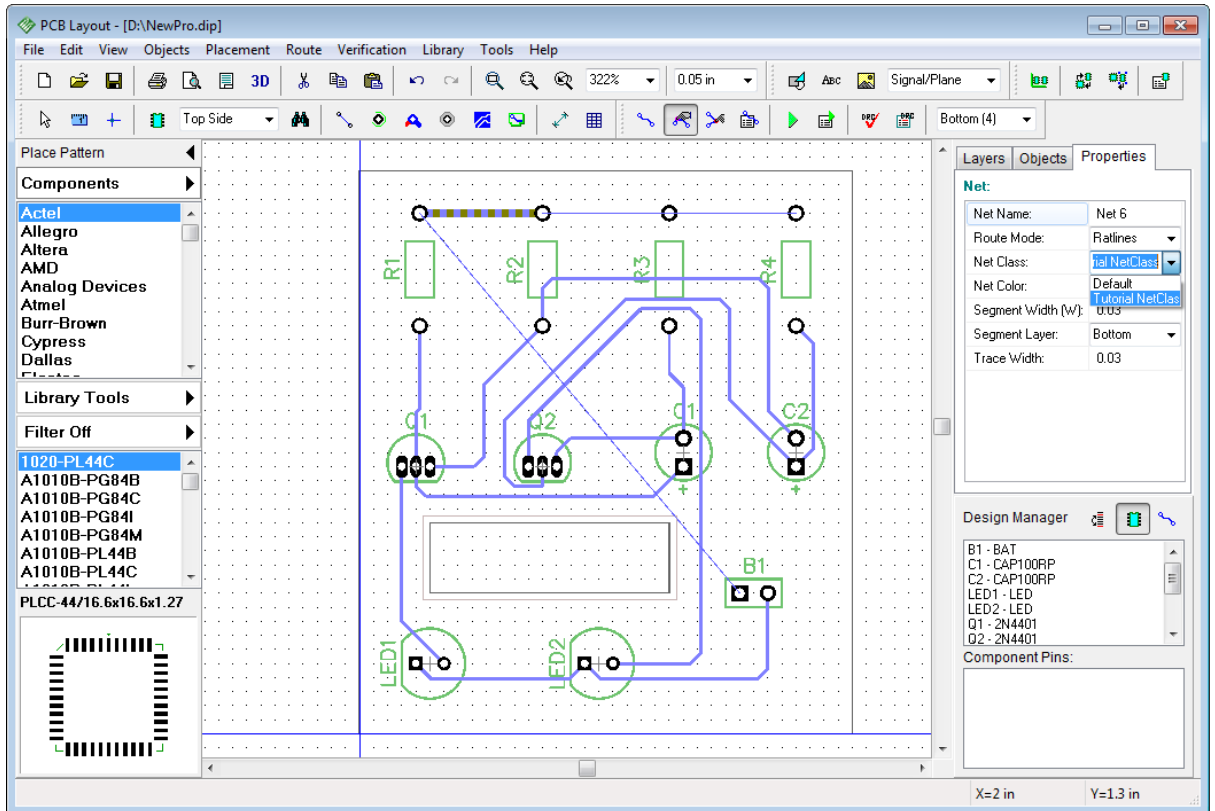

We don't need that trace width diversity on the board. Please **Undo (Ctrl+Z)** several times or manually delete all custom net classes, via styles, and inner layers to get the layout right after [autorouting](#)<sup>38</sup>.

Save the project ("File \ Save" from the main menu).

## 2.7 Manual routing

Simple projects like ours can be routed automatically, but for complex boards, manual routing is a must. Actually, the entire board can be routed manually but because of low speed of manual routing usually a combination of two methods is the best choice for complex projects. This allows the designer not only to get a well-working prototype but to succeed in reasonable terms. Critical nets are routed manually and the rest – with autorouter.

Our simple board is already good enough, but we're not done with practicing yet. Moreover, sometimes you may need to correct traces after the autorouter.

### Editing modes

You should already know how to create traces – select "Route \ Manual Routing \ Add Trace"

from the main menu or press  button, then left-click on the first pad to start routing, and click on the next pad to create a trace. Just make sure that correct layer (Bottom) is selected.

Editing traces is a bit different. Press  button or simply left-click on the trace and drag & drop trace to another location. The **Edit Traces mode** allows the user to move traces with 45- or 90-degree angles. This is very convenient for almost any design, but sometimes you might need traces editing tool with more capabilities. Go to "Route \ Manual Routing \ Free

Edit Trace" from the main menu or press  button on the Route toolbar. Now you can edit traces without any restrictions.

Don't forget to change the grid size (with the  drop-down on the Standard toolbar or *Ctrl+Plus Sign* and *Ctrl+ Minus Sign* hotkeys). To configure the list of available grids, select "View \ Customize Grid" from the main menu. *F11* hotkey hides or shows the grid on the design area.

*Remember, if you don't know which tool you are working with, right-click a couple times on a free spot on the design area and DipTrace will return to the Default mode.*

## Nodes

Any routed net is divided to traces (often called "tracks"). Trace is the copper track between two pads of the net. Trace (track) consists of segments. A segment is a route between two nodes. Node is a point on the route, which divides a trace to segments (red dot and a small square in the picture below). The designer can move existing nodes, add new ones or delete them. This gives more opportunities while editing traces. Left-click on the trace segment, and press *N* hotkey to add a new node in selected place, then select it, and move to some point outside the board outline (**Free Edit Mode** in the picture below).

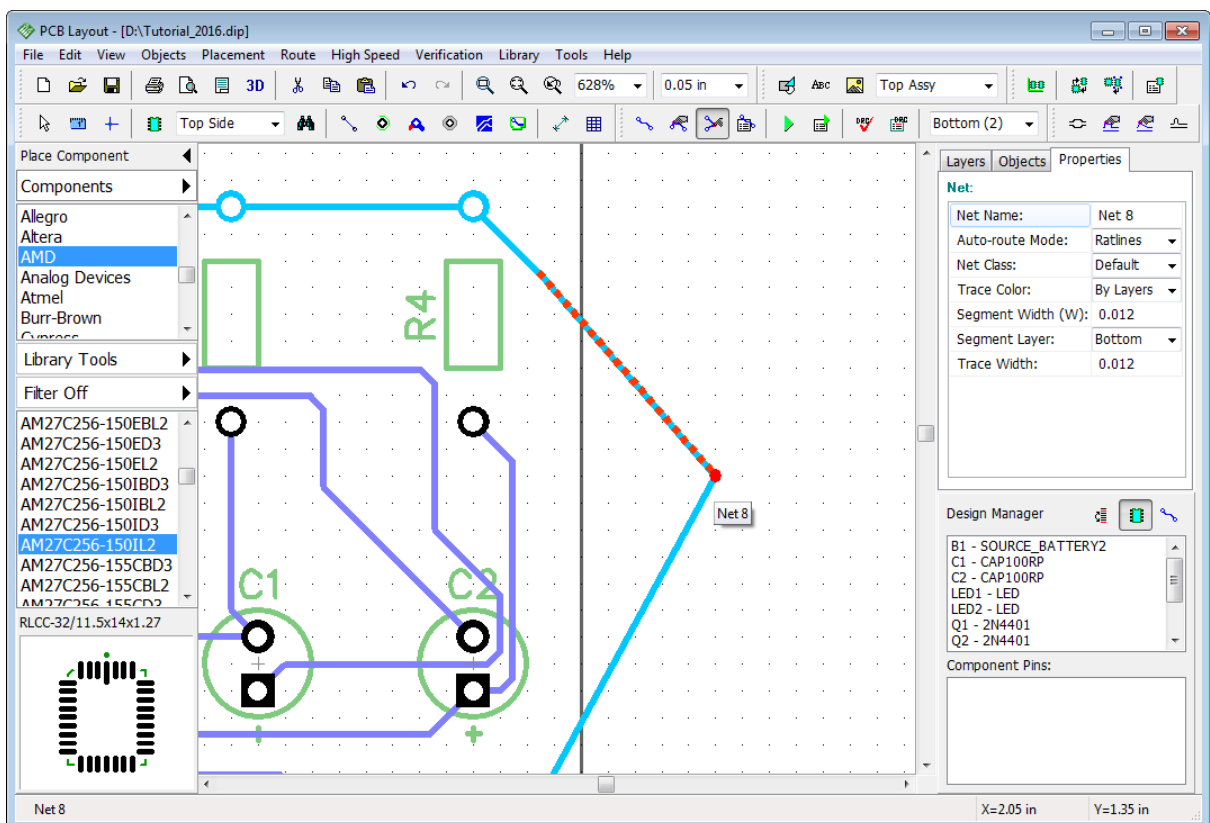

If you don't need some node anymore, you can delete it – right-click on the node, and select **Delete Node** from the submenu. In the same submenu, you can change the name, color, width, and the layer of the net, trace or segment etc.

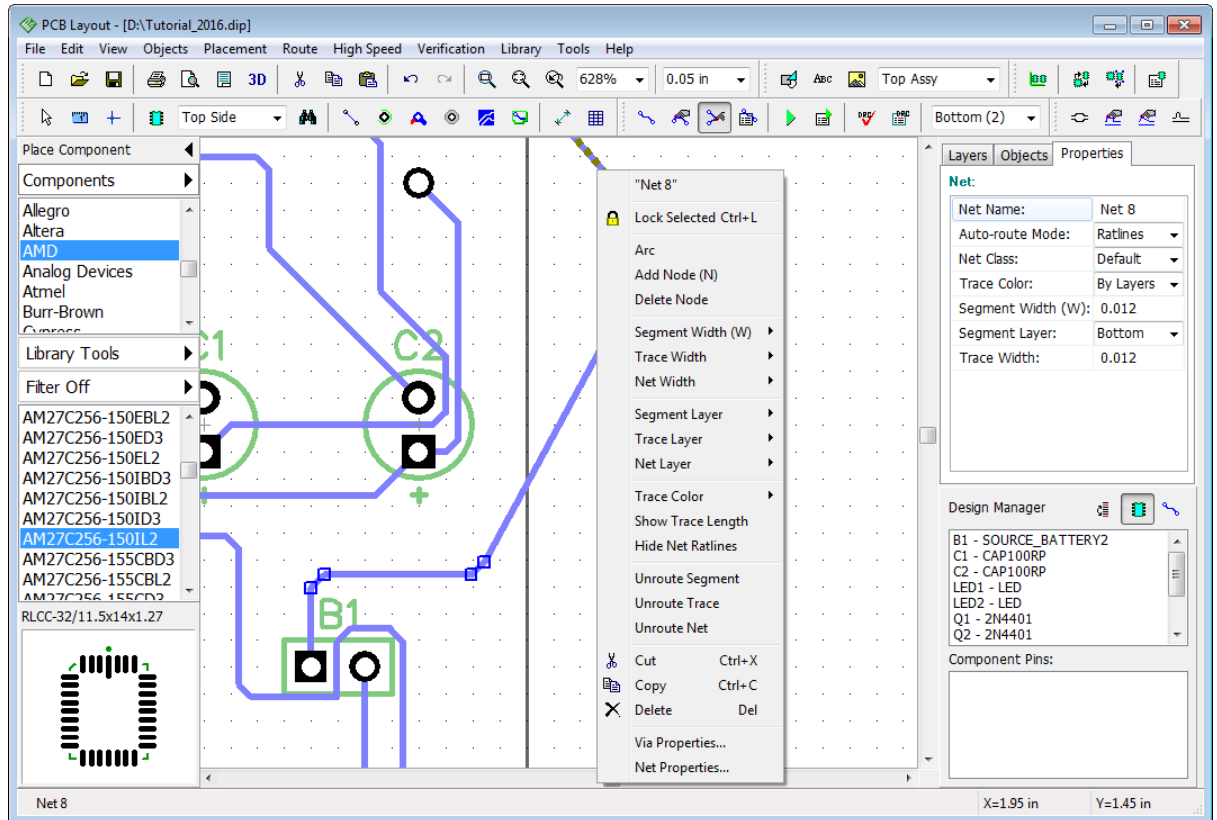

Manual routing offers greater opportunities, but with more chances to commit an error. Fortunately, the DipTrace has Real-time Design Rules Check which verifies board in real time and enables the user to see errors **before** actually making them. We will have a detailed discussion about DRC [later](#)<sup>[73]</sup>.

### Real-time DRC

Let's turn ON Real-Time DRC and continue. Go to "Verification \ Design Rules", in the pop-up dialog box check **Enable Real-time DRC**, then select the **Real-time DRC** tab, and check **Manual Routing** and **Moving Objects** options (if not already selected). Press **OK** to close the **Design Rules** dialog box. You can see that two red circles have appeared at the points where the trace crosses the board outline, these circles show errors.

Now select a random trace and intentionally move it too close to another trace or object. Red circles report a clearance error **before** you place the trace to a new position, the same happens when you move objects or edit components if the corresponding items in **Real-time DRC** tab have been checked.



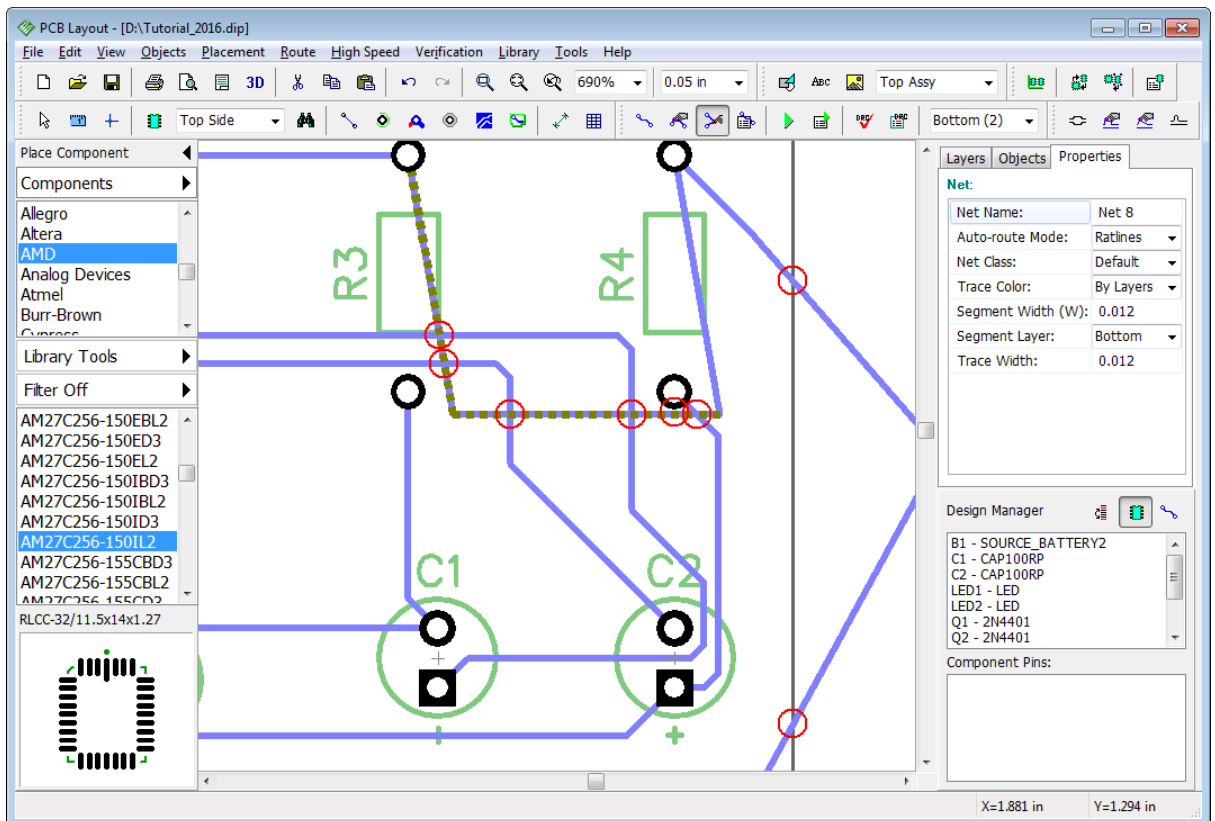

Notice that we have hidden the grid in the picture above (*F11* hotkey) for more precise editing. Now return the trace (between R3 and R4) to its initial position.

### Change layer

DipTrace allows you to move existing net (trace or trace segment) to another layer, right-click on the trace segment of the net, and select "Segment Layer \ Top" or use the **Segment Layer** drop-down list in the **Net Properties** panel on the Design Manager. Two trace vias appear automatically. You can choose several segments of the same or different nets with *Ctrl* or *Shift* buttons and change their properties at a time.

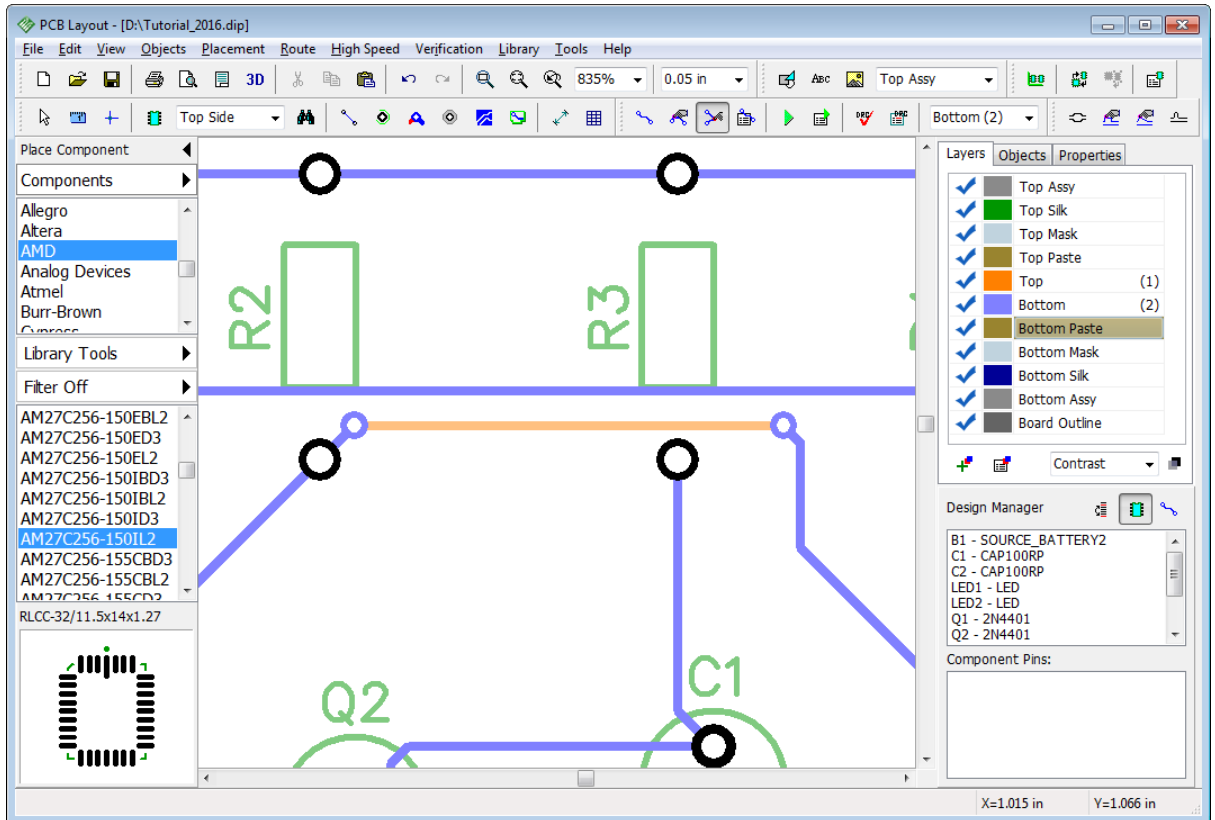

Now return that segment back to the Bottom layer, and select the bottom layer on the Design Manager.

### Manual routing panel

It's time to practice more in the manual routing. Right-click on one of the nets, and select **Unroute Net** from the submenu. We have selected Net 8, but you can choose another one. The "Unroute Net" command from the net submenu applies to all selected nets. Then press



button on the Route toolbar. Manual Routing panel is on your right-hand side (Design Manager panel). Do not try to change the net class of existing net in there, net class should be defined in the Net Properties or Net Classes dialog boxes **before** routing.

*Notice that you cannot change the net class of existing net in the **Manual Routing Panel**. This change will be ignored and applied only to the new net. Don't forget that net exists not depending on whether it is routed or unrouted.*

Fortunately, we have only one net class to avoid confusion and concentrate on the subject.

In the **Route Mode** drop-down list (on the Design Manager) we can specify the group of trace segments that we are going to need for routing, therefore, we will be able to select current segment not from the list of all segments but from the list of segments of one mode. Custom route mode is available.

Select the **Arcs/Curves** route mode, then left-click in the **Current segment** field and select **3-point Arc**. Left-click on one of the pads of unrouted net (this will be the first point of an arc), then left-click on some point between the two pads higher than the blue connection line (this is the second point), like in the picture below.

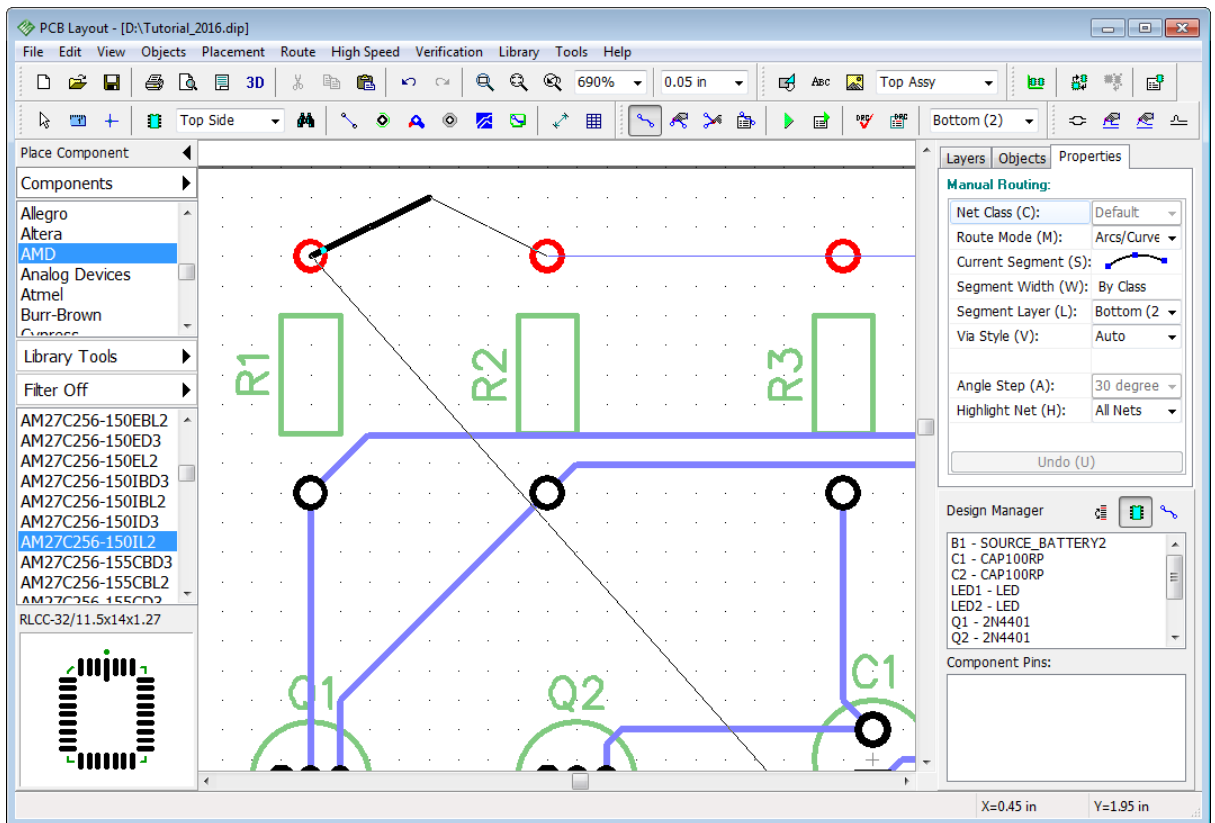

Then move mouse arrow to the second pad, and left-click it. You will see an arc.

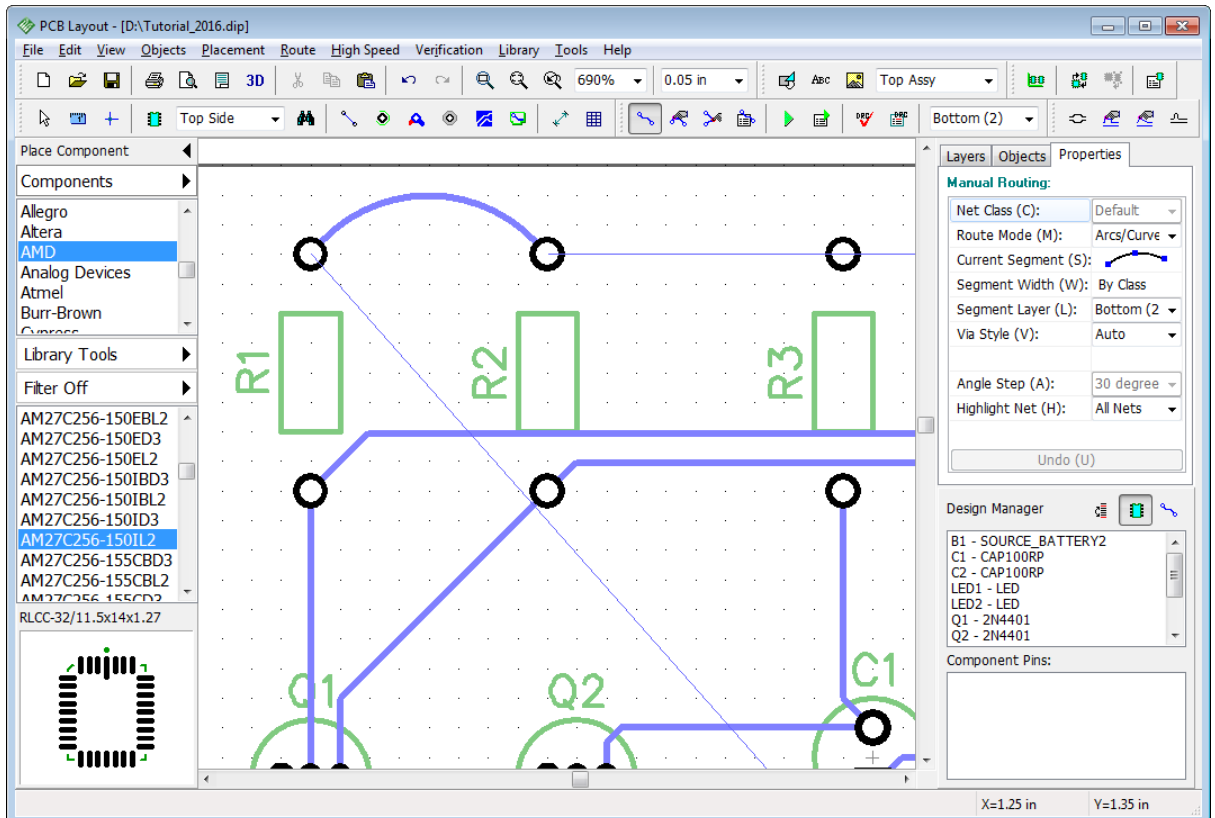

On the **Manual Routing** panel, you can choose highlighted nets. If you highlight only current net – no other nets will glow, even if you'll touch them with the new trace.

You can undo by pressing the *U* hotkey while routing. Notice that there are hotkeys that will make manual routing really easy and quick.

*M* – switch between routing modes,

*S* or *Space* – change current segment,

*W* – set trace width,

*T* – switch to Top layer,

*B* – switch to Bottom layer,

*L* – segment layer,

*J* – switch to jumper wire or back (if you are in Bottom layer, jumper will be placed to Top and vice versa),

*A* – angle step,

*H* – highlight net,

*1 – 0* in the top of keyboard – switching between layers (up to 9).

Go to "Tools \ Hotkey Settings" from the main menu to view and change the hotkeys. Refer to the PCB Layout Help document ("Help \ PCB Layout Help") for more details about custom keyboard shortcuts and manual routing.

Now please **Undo (Ctrl+Z)** several times or change the layout to the state after autorouting (no net classes, via styles, new layers etc.).

## 2.8 Measuring trace length

DipTrace allows for easy and convenient trace measuring. The current project is simple, therefore we don't need to use this tool but if you design high-speed circuits with differential pair signaling, trace length becomes very important. This tool is often used with trace [length matching tools](#)<sup>[186]</sup> which we will review later.

*Notice that hint of each trace already includes its length.*

Please select several traces (you can use box selection or *Ctrl* button). Right-click on one of selected traces, and choose **Show Trace Length** from the submenu.

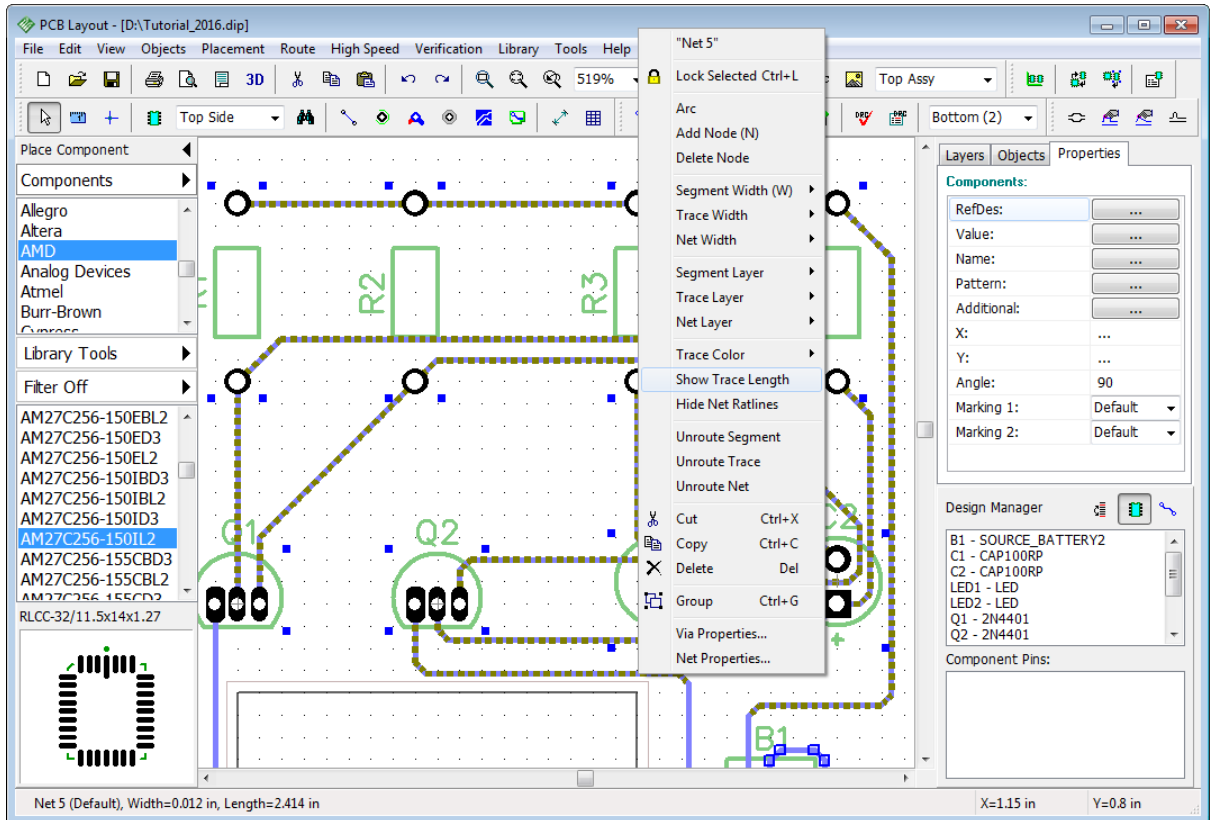

You will see the small boxes with trace length values near all pads of selected nets, they are also highlighted when hovering over the trace with a mouse cursor. Values are in current measurement units (inches in our case), they change in real-time when you edit the trace. Notice that in some situations you may be unsatisfied with the current color. Trace color depends on the layer color.

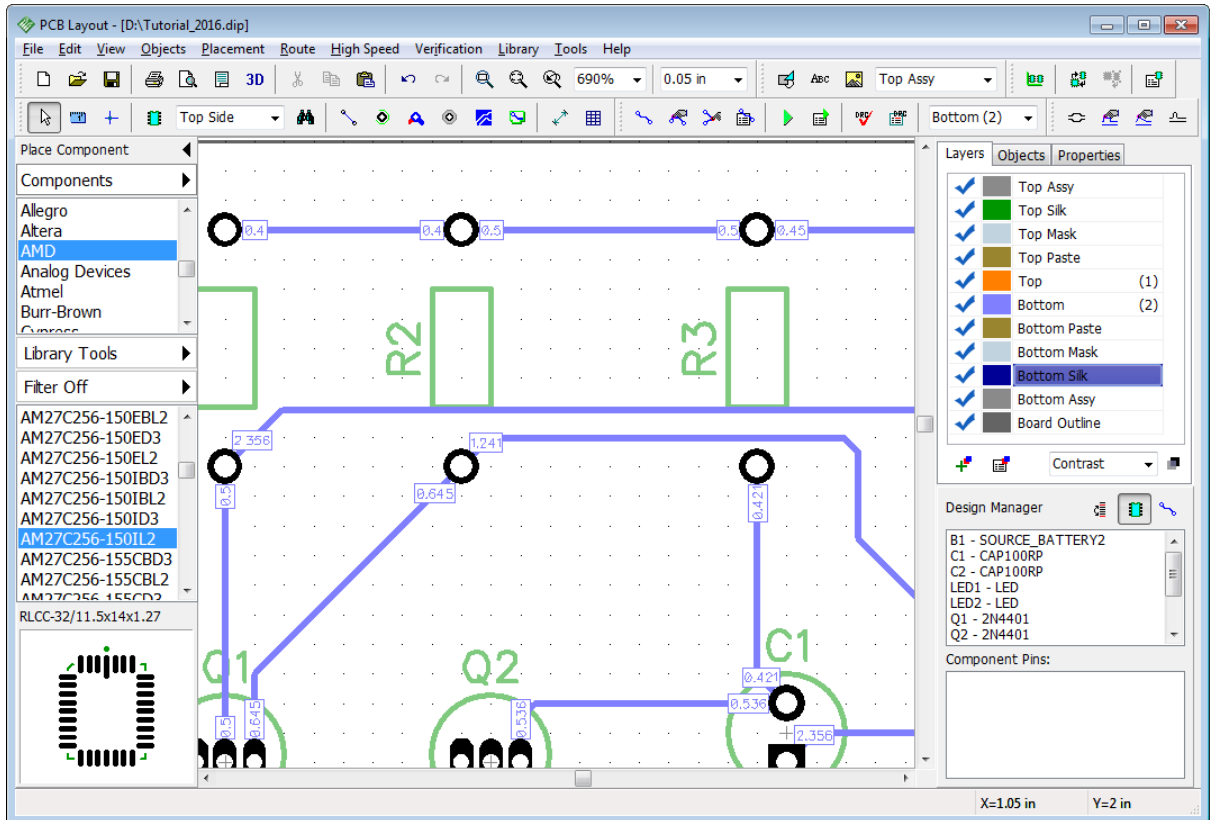

Notice that DipTrace can calculate a phase shift considering [layer stackup](#)<sup>[182]</sup> (via height) and the length of bonding wires inside a component (determined by the [Signal Delay](#)<sup>[191]</sup>).

By default, DipTrace does not consider these values for trace length calculation. If you want to consider them, go to "High Speed \ Length Matching" from the main menu, then press  button, and check **Enable Layer Stackup** and **Enable Pad Delay** in the **Length and Phase Measurement Settings** dialog box.

Now please hide the trace length boxes, using the net submenu (select the same item) or **Undo** tool.

## 2.9 Selecting objects by type/layer

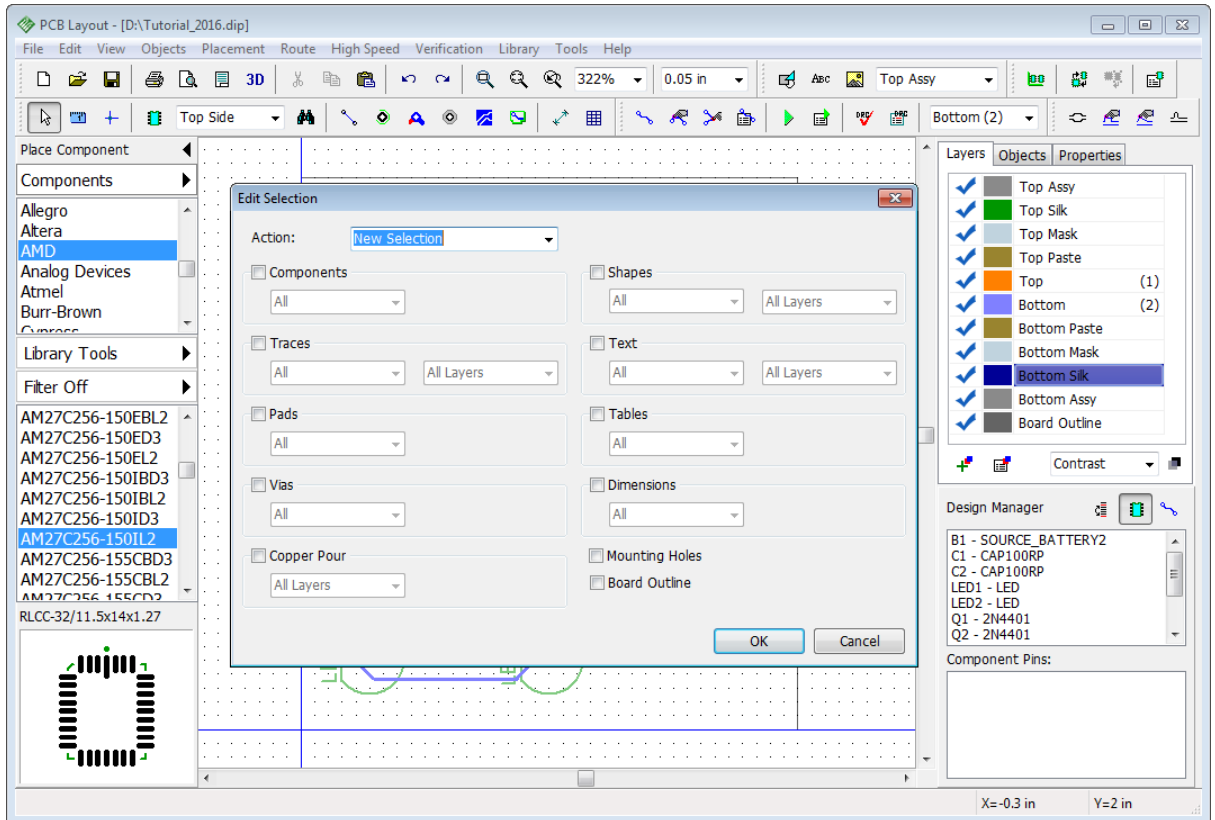

Sometimes it is necessary to select all objects on one layer or exclusively components, nets, vias etc. With the current layout, it is very easy to achieve visually with the mouse and **Ctrl** key, but what if the layout is very complex?

Select "Edit \ Edit Selection" from the main menu.



Check **Components** item, and click **OK** – all components are selected now.

Let's make it a bit harder and model a real-life situation when we need to select only unconnected vias in the predefined area of the board.

First of all, deselect components with a right-click on an empty spot. Then place several static vias and connect **only some of them** to nets randomly, while leaving a couple of vias unconnected. Use "Objects \ Place Static Via" from the main menu or  button to place vias and "Objects \ Place Ratline" or  button – to create connections visually. Left-click on the via, and then left-click on the pad to add via to the pad's net.

Now define selection area using the box selection. This box represents an area where we plan to select unconnected vias so we will not include all vias of the layout to this selection. Notice that we are on the Bottom layer, where we have all the traces.

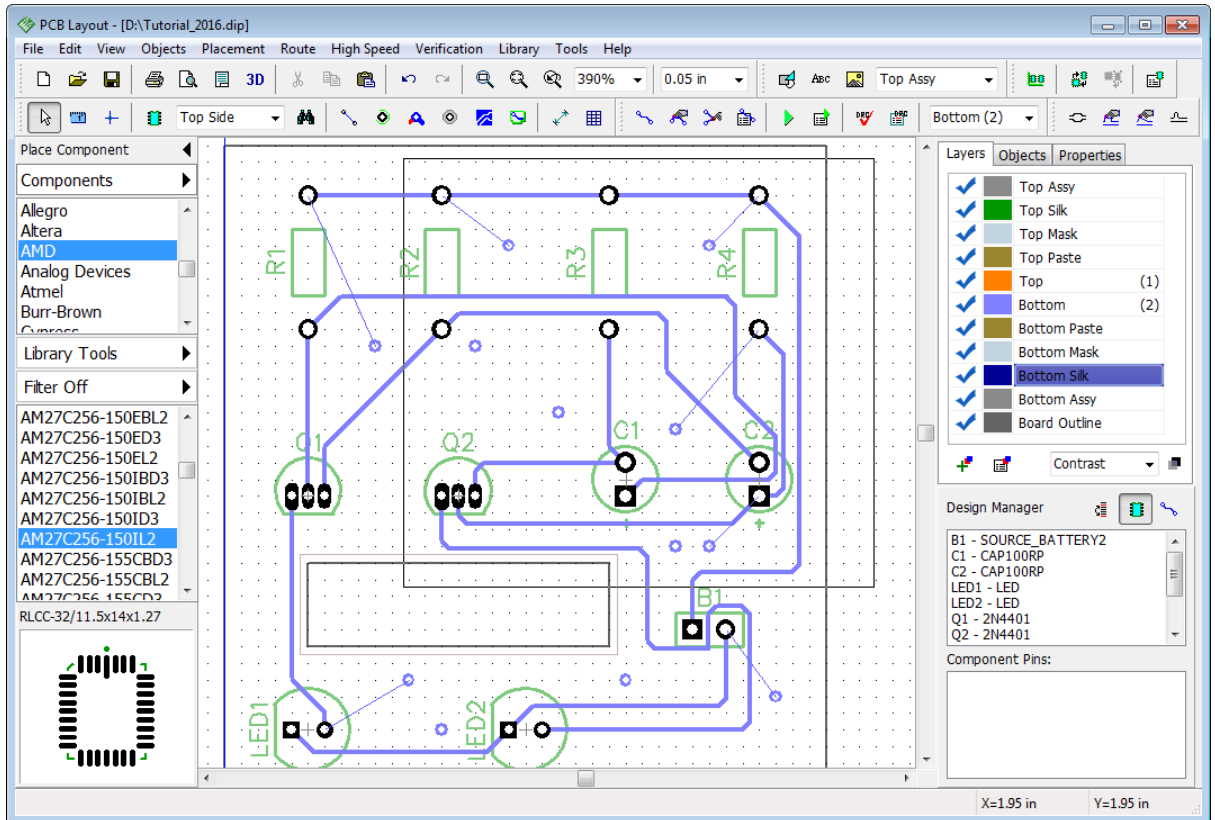

All objects in the box are selected. We need to extract only non-connected vias from the selection. Open "Edit \ Edit Selection" dialog box, choose **Mode: Keep Selected**, check only **Vias** checkbox (other boxes should be unchecked), and then select **Not Connected** from the **Vias** drop-down list. Click **OK** and only unconnected vias becomes selected.

The next step could be connecting these vias to some net, all at a time. In real life, this can be used to connect ground net to plane/copper pours. Right-click on one of selected vias (it should be highlighted in red), select "Add to Net \ Selected Vias" from the submenu, and specify the net in the pop-up dialog box.



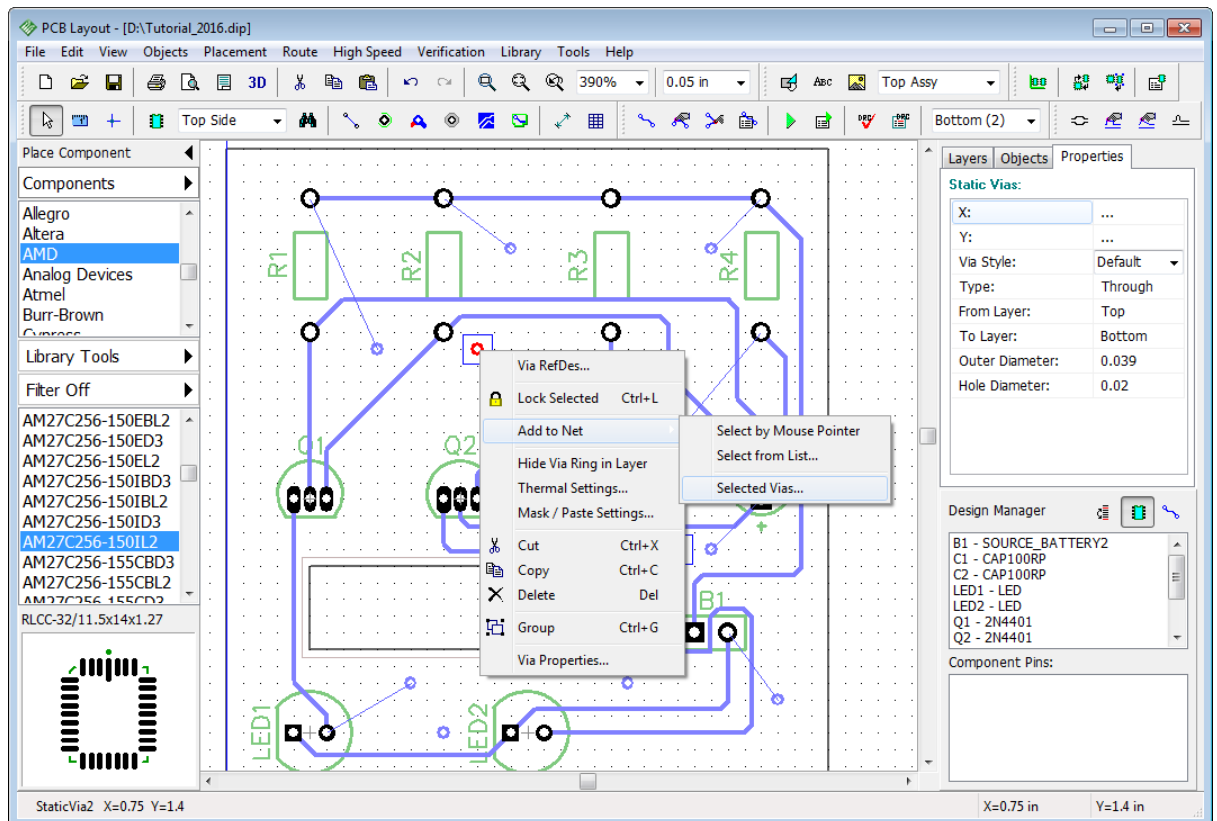

Choose some net from the list, and click **OK**. All vias will be connected. Remove all static vias from the board and return the circuit board to the previous state (select all vias and press *Del* key) or **Undo**.

## 2.10 Placing text and graphics

With DipTrace you can add texts, shapes, and logos in BMP, DXF, or JPEG formats directly on the board and export them to Gerber.

Select the layer where you're going to place graphics, usually, it's a silkscreen layer (Top Silk in our case), double click it in the **Layers** tab of the **Design Manager** panel.

PCB Layout allows the user to change layers with two drop-down lists on the Instruments toolbar and in the Layers tab on the Design Manager panel.

Drop-down list on the Drawing toolbar allows you to select any non-signal or Signal / Plane layer for placing graphics. If you have selected Signal / Plane layer, all shapes, texts and logos will appear on current signal/plane layer, which is specified with the drop-down list on the Route toolbar.

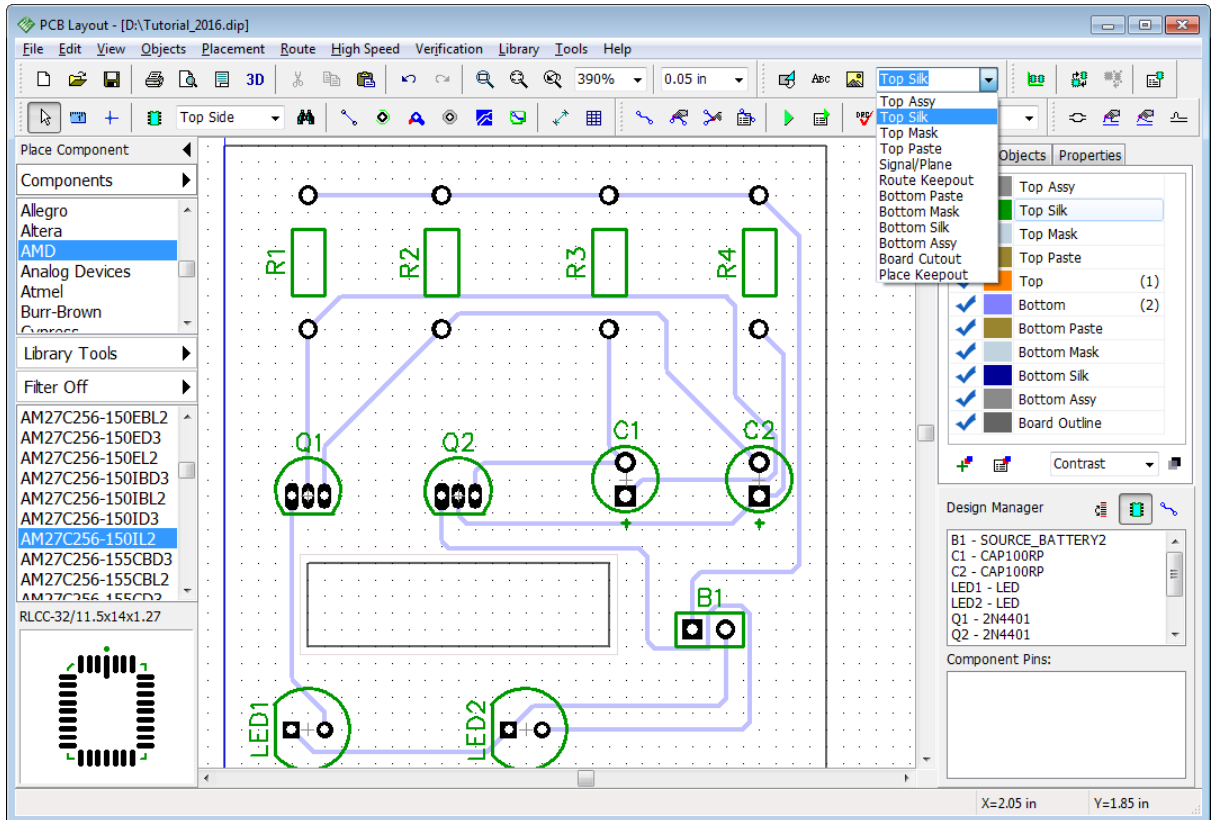

Let's make the board polygon a little bit bigger to place additional text at the top. Drag and drop upper-left and upper-right vertices of the board outline a little bit upwards. Make sure you click on the vertex point, not on the outline. DipTrace makes visual editing very easy with appropriate grid size.

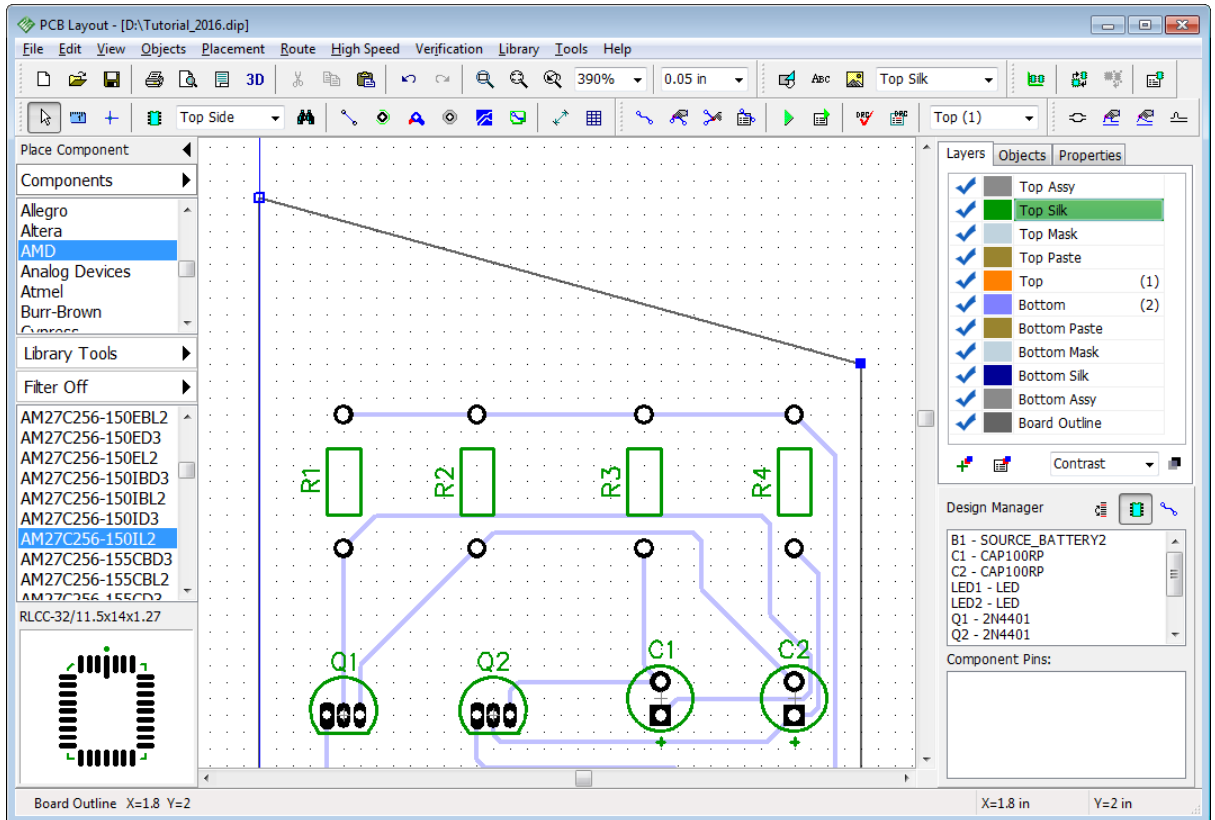

You can move the board outline. Left-click on the line (not the vertex), then drag and drop it.

Remember that if you can not highlight and edit certain objects, probably, you are not in the default mode. Therefore, right-click on a free area to cancel current mode. Objects located on inactive layers of the board can't be edited (unless you are in the Contrast Edit layer display mode).

Press  button, left-click where you would like to place text, type in the text, and press *Enter* to finalize.

Use the mouse to move text around the design area until you'll find a good location. When a text object is selected, font settings, font type (Vector, TrueType), and text layer can be changed in the **Text Properties** tab on the **Design Manager**, or with the right-click submenu. Use vector font, because it is directly exported to Gerber. For Unicode and Non-English characters select TrueType fonts, however, these export to Gerber as small lines (created by a special recognition algorithm).

*Some PCB manufacturers do not accept TrueType text objects in copper layers.*

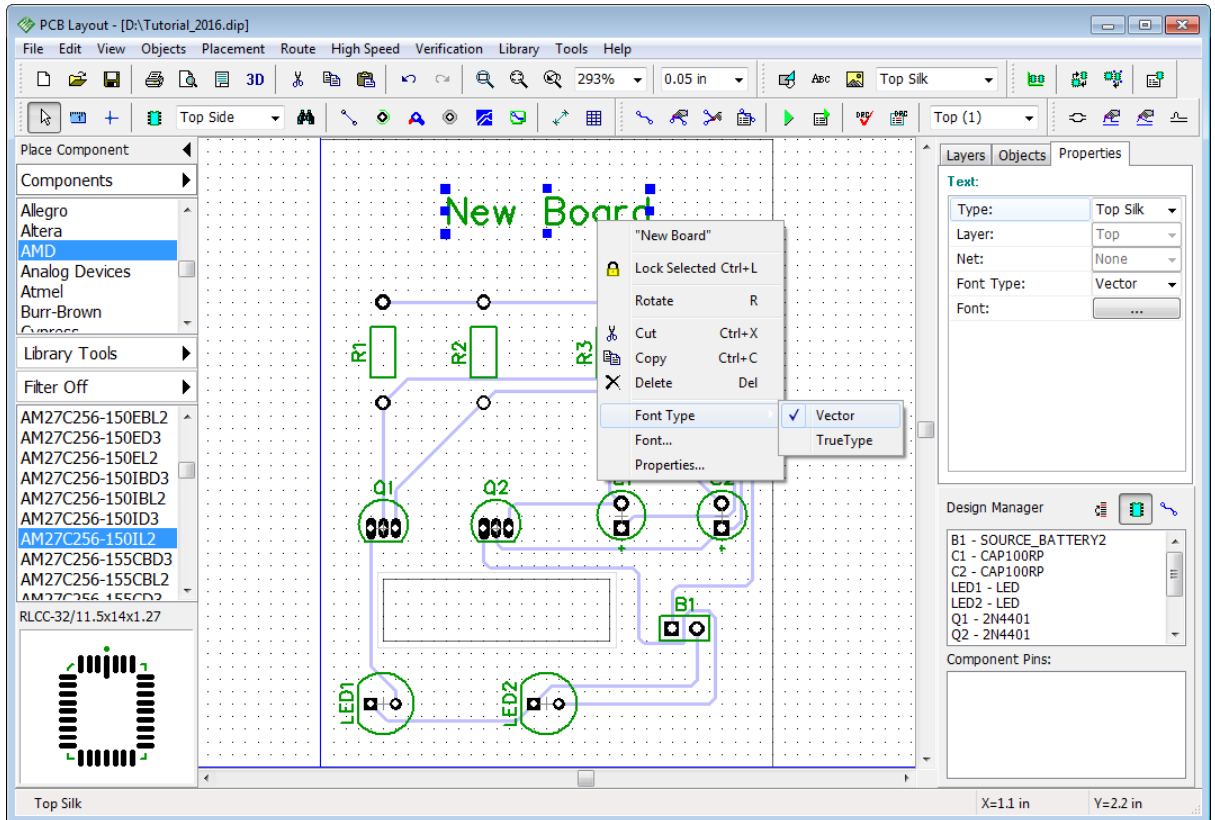

The text object is on the silk layer, it inherits the layer's color. If you need to change the text color, move the text object to the Top Assy layer and then change Top Assy color.

You can change layer of the graphics and text object any time. Select a graphic object, right-click it, and select **Properties** from the submenu. In the pop-up dialog box select another PCB layer in the **Type** field to move the object to another layer or define different properties (for example, create a route keepout used for autorouting, etc.). In our case, we just leave that text on the Top Silk layer.

Notice that you can add shapes to mask, paste, signal, route keepout and board layers. These properties can be defined on the Drawing toolbar or in the Shape Properties dialog box.

## 2.11 Copper pour

Copper Pour is used as a low-impedance conductor for Power and Ground nets. Pours are usually located on inner layers of the board but can be placed on top and bottom sides as well.

### Place copper pour

Change the grid size to comfortable 0.025 inch. Select the Bottom layer, then go to "Objects \

Place Copper Pour" from the main menu or press  button on the Elements toolbar. Now you can draw a copper pour polygon borderline by defining its key points on the design area, then right-click on the last polygon's point, and select **Enter** from the submenu to finish drawing. We need a copper pour that covers the entire bottom layer of the board. You can draw a precise polygon manually or create a random shape (for example, like in the picture below) and use the Depending on Board feature which will pour the entire layer automatically

(regardless of the initial shape). When you select Enter from the submenu, the **Place Copper Pour** dialog box pops up.

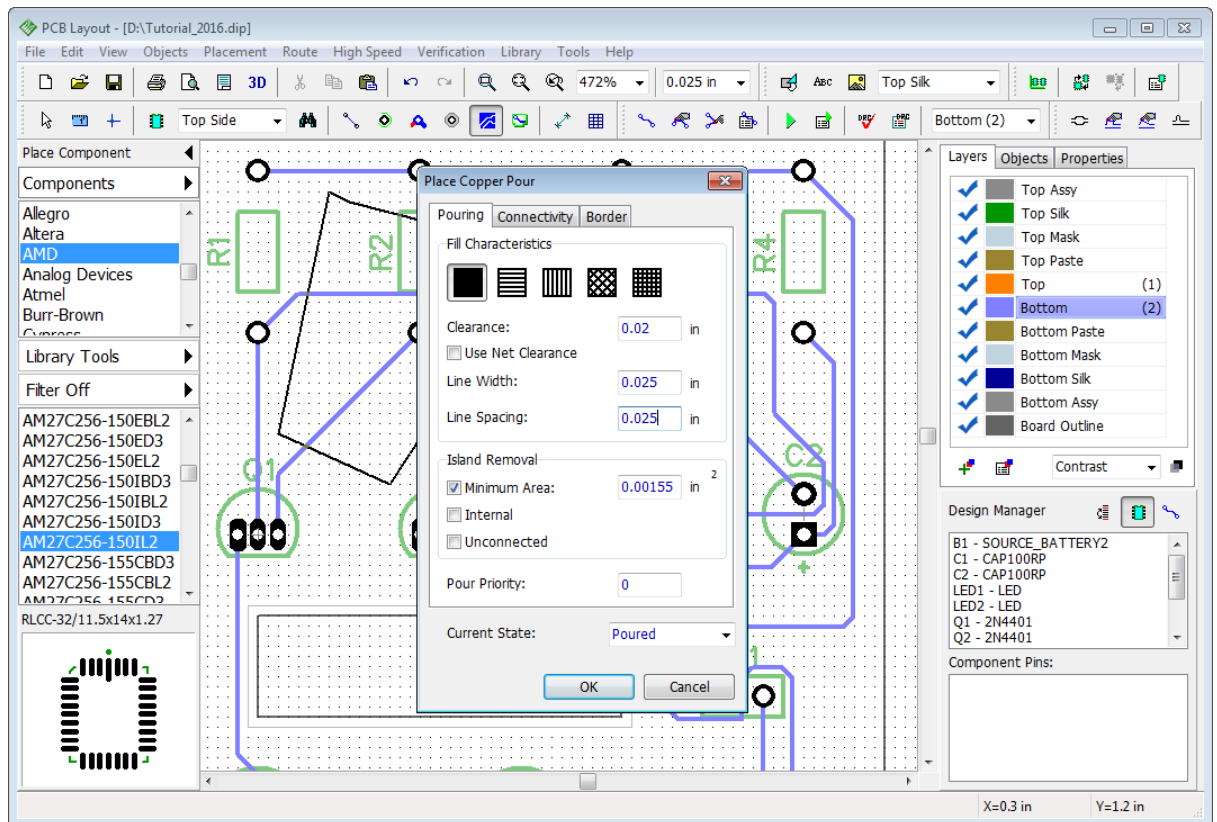

This dialog box has three tabs: Pouring, Connectivity, and Border.

**Pouring** tab allows you to specify different non-solid fills for the copper pour, clearance width, line width, line spacing, island removal options, pour priority, and current state (poured or unpoured). You can also apply net clearances as copper pour clearances by checking the corresponding item. DipTrace has shape-based copper pour system.

**Connectivity** tab – here you can connect copper pour to the net, select thermals and change their settings. DipTrace supports separate thermals for SMD pads. The **Hide Net Ratlines** regime can automatically show ratlines only for unconnected traces or other if specified.

**Border** tab allows you to define the border points and build the copper outline automatically.

Check **Depending on Board** checkbox and keep all other settings like in the picture above. The **Snap to Board** checkbox means that copper pour will resize depending on the board outline. Click **OK** to place a copper pour.

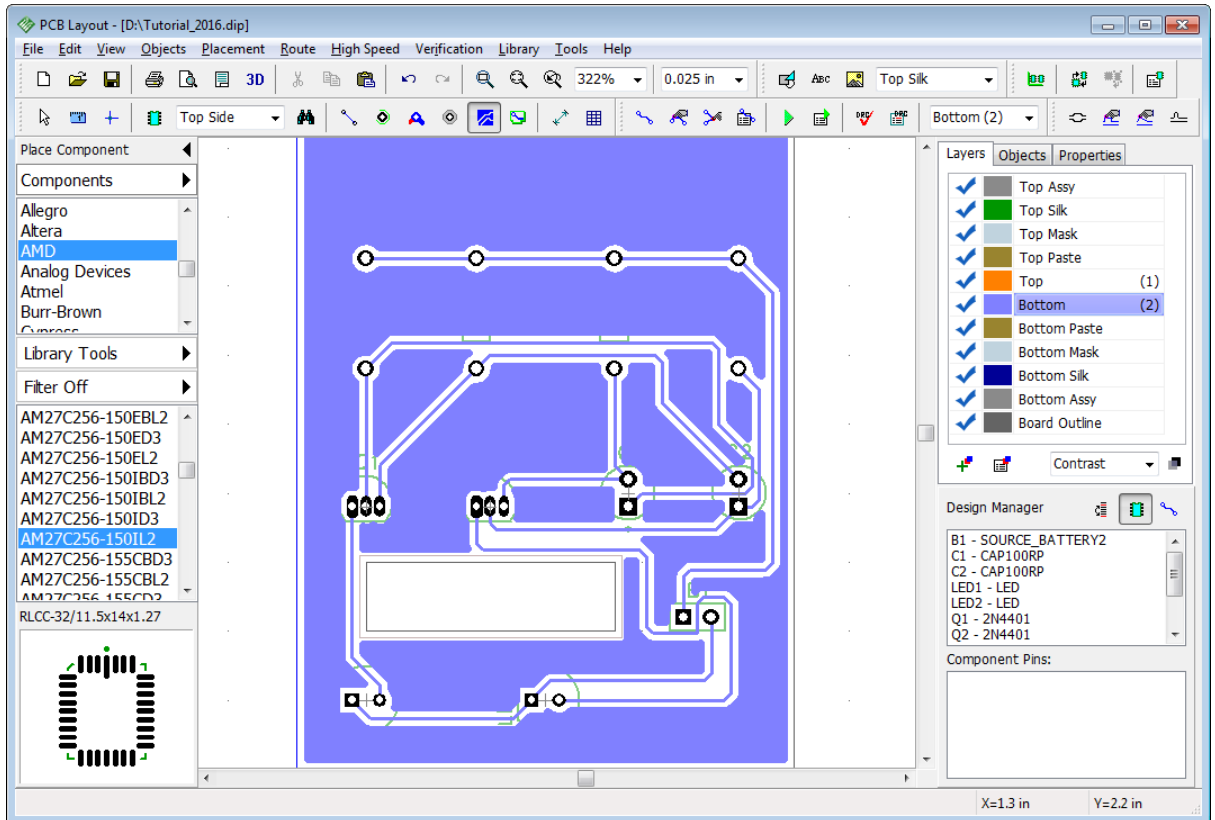

*Board outline clearance specified in the copper pour settings is not applied to board cutouts. Always use route keepout to allow for a certain clearance between the copper pour and cutout, like we did before.*

Copper pour can be in two states: Poured and Unpoured. The second state is often used for editing because only the copper pour border is visible in the Unpoured state. To change the copper pour state **right-click on the copper outline (not on the copper pour's body)**, select **State** from the submenu, and choose the item you need.

As you can see, we have a copper pour, but it is not connecting any net. Now we will practice and connect two different nets using two copper pours on the Bottom layer. Copper pour priority option will help us to achieve our goal.

### Connect copper pour

Unroute one of the nets (for example, Net 8 which connects resistors to the battery), right-click on the trace, and select Unroute Net from the submenu. Remember the net name ("Net 8"). Right-click on the copper pour border, and select **Properties** from the submenu. Go to the **Connectivity** tab, and select **Connect to Net: Net 8**, then select appropriate thermals (for example, **4 spoke**), and press **OK** to update the copper pour.

*Notice that you should click directly on the copper pour border (not on the copper body or the board outline) in order to open copper pour properties dialog box.*

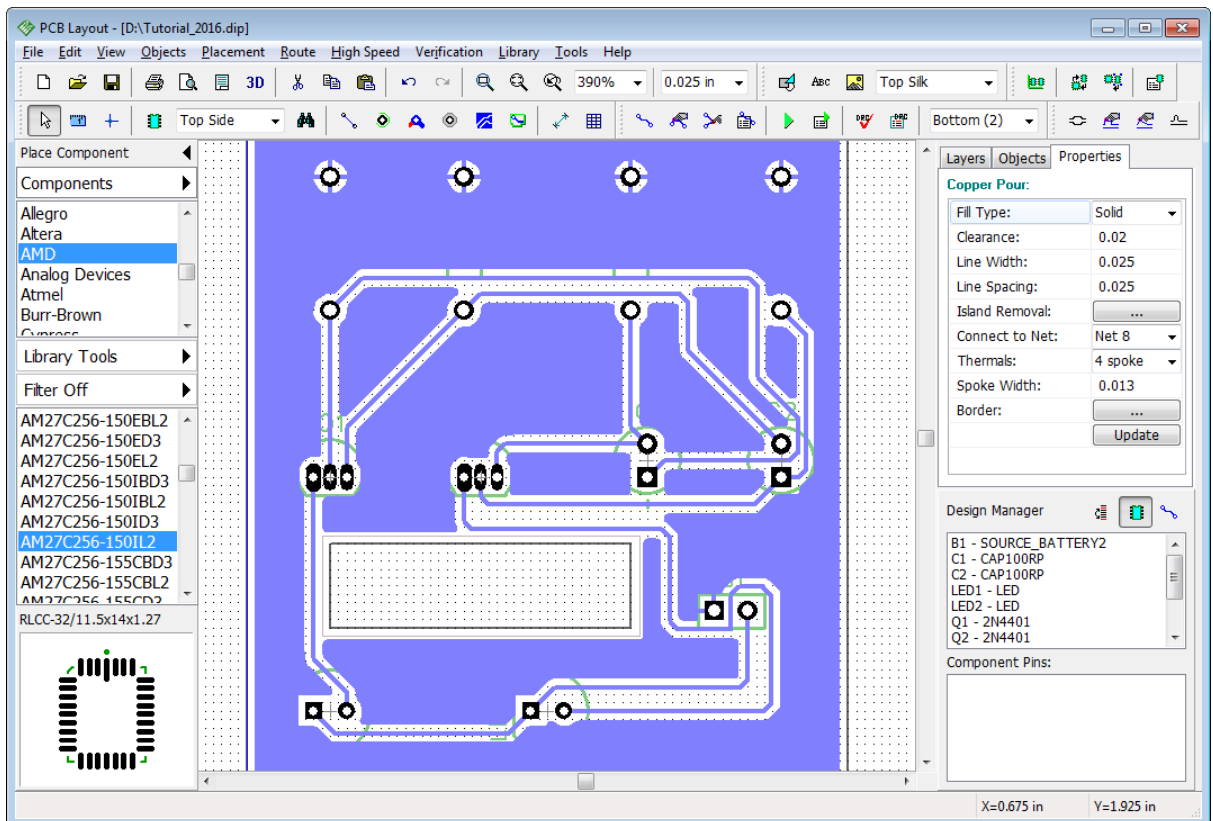

You can see that connection lines (ratlines) are hidden now and the net (Net 8) is connected to the copper pour with thermals of selected type (4-spoke thermals).

Now we will place the second copper pour. Select another net that we will connect with a copper pour (for example, Net 3 that connects R3:1, C1:2, and Q2:3) and unroute it, then right-click **on the edge** of existing copper pour, and open the **Copper Pour Properties** dialog box. Select **Current State: Unpoured**, but do not close this dialog yet.

### Pour priority

Now it's time to change the pour priority for existing copper polygon. Specify: **Pour priority: 1** in the **Pouring** tab.

You can enter any value, depending on how much copper pours you plan to have on this layer. A lower value means higher priority, therefore copper pour with **Pour Priority: 0** will have higher priority than **Pour Priority: 1**.

*Notice that two different-net copper pours with the same priority level will intersect. Real-time Design Rule Check will show numerous errors in this case.*

Press **OK** to apply new settings. Notice that in unpoured state ratlines are displayed automatically. Unroute Net 3, then select copper pour placement tool ("Objects \ Place Copper Pour"), and draw the second polygon that covers pads of the Net 3, like in the picture below.

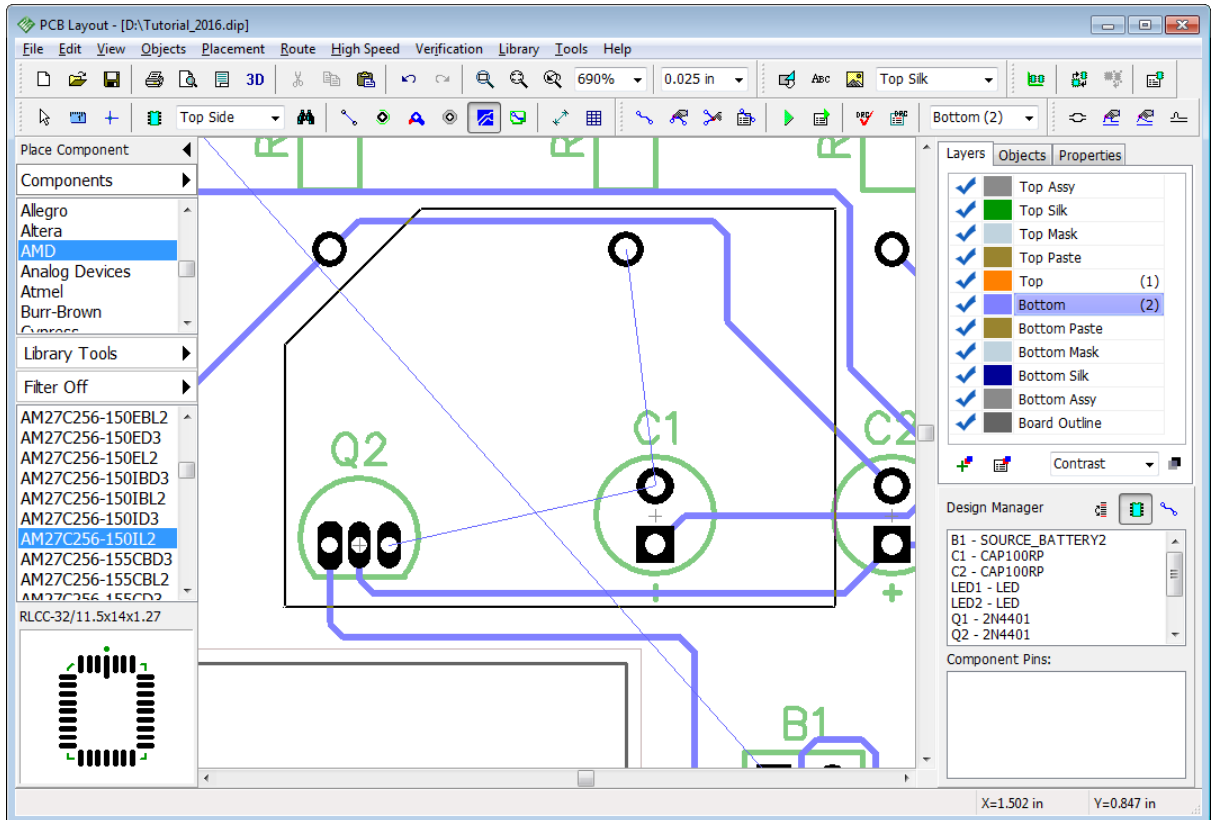

In the pop-up dialog box connect the second copper pour to Net 3, and specify the thermal type (**4 Spoke** should be fine). Press **OK** to close the dialog box and create a copper pour polygon.

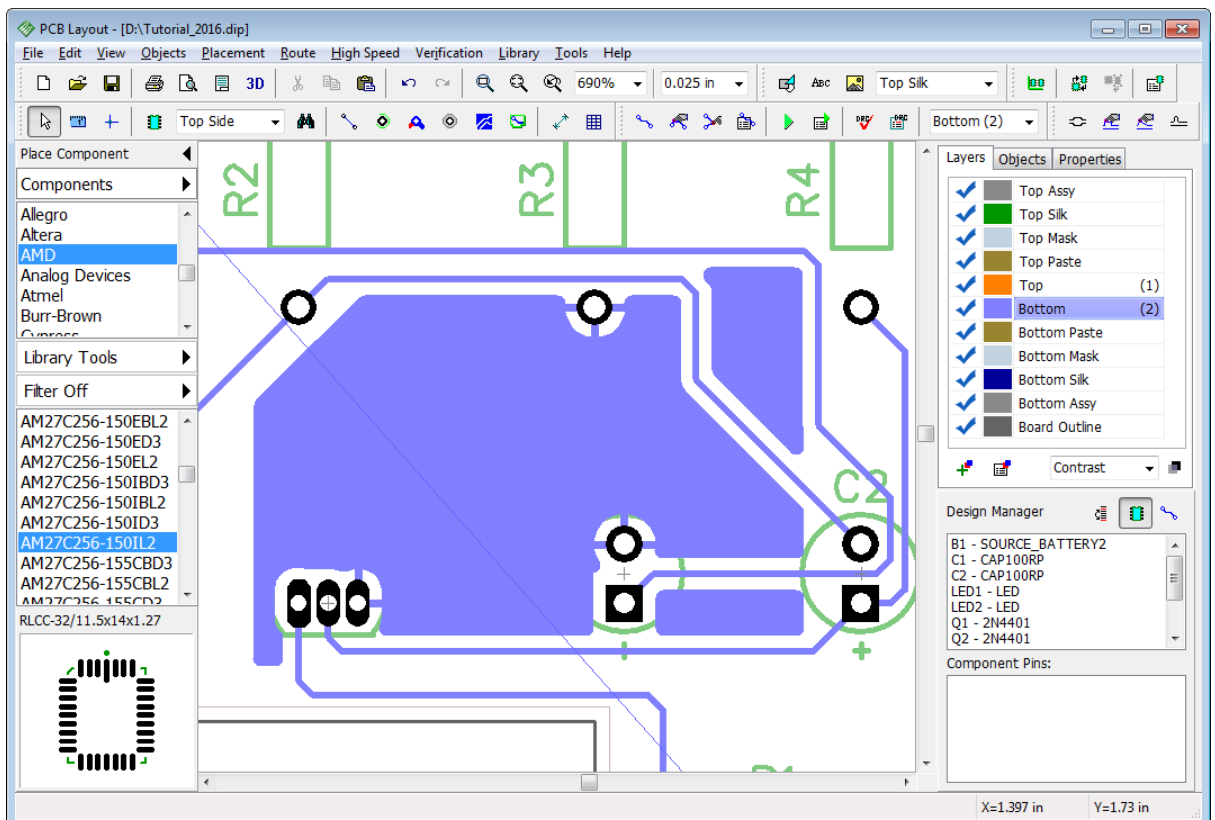



Now select Net 8 copper pour, which is unpoured now. Right-click on its border, and select "State \ Poured" from the submenu. You will see that two copper pours connecting two different nets are independent and Net 8 copper changed according to the Net 2 polygon which has higher priority level.

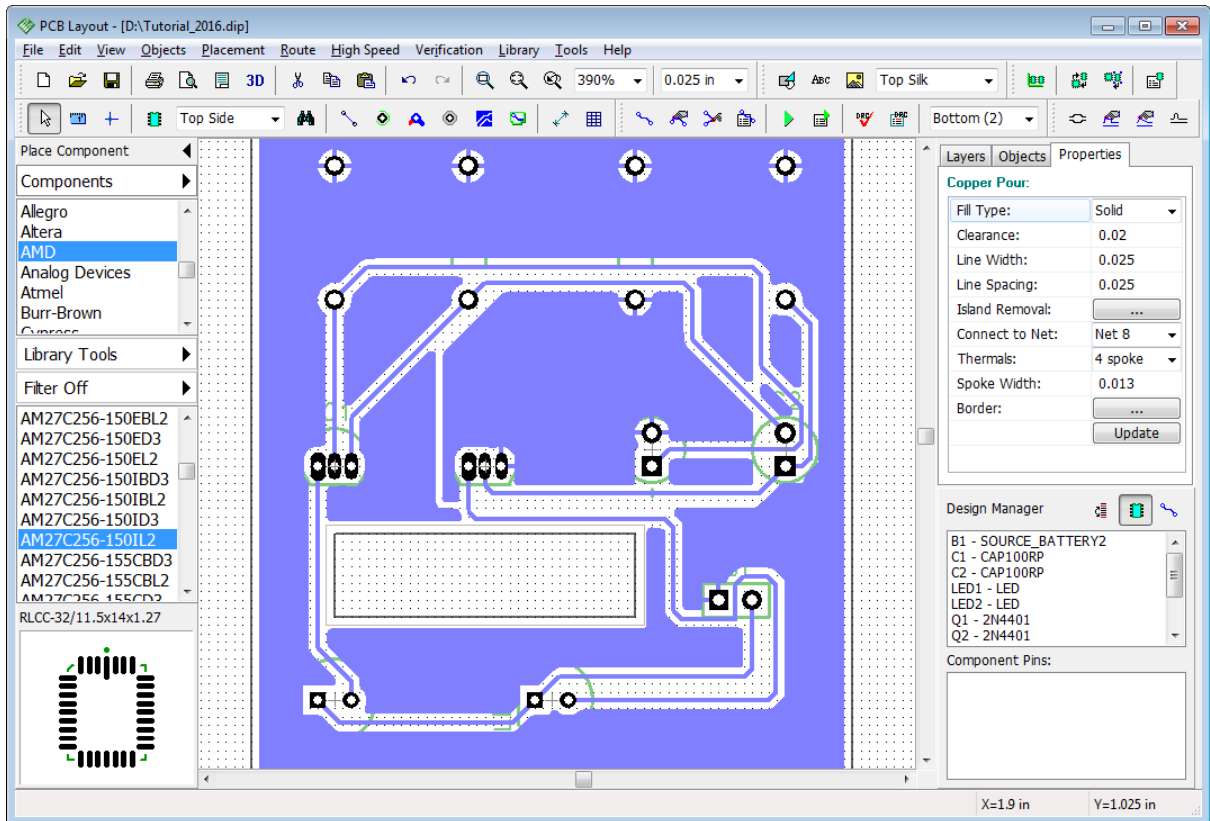

### Thermals

Some pads require custom thermal connections that will be different from the copper pour's thermals. Right-click on the pad (when the pad is highlighted), and select **Thermal Settings** from the submenu, then check **Use Custom Settings** checkbox, and select a new thermal connection.

Some pads can become unconnected after placing a copper pour, because of selected thermal type and the layout structure (net connectivity check will report this), so selecting separate thermal settings for pads will help you to fix those issues.

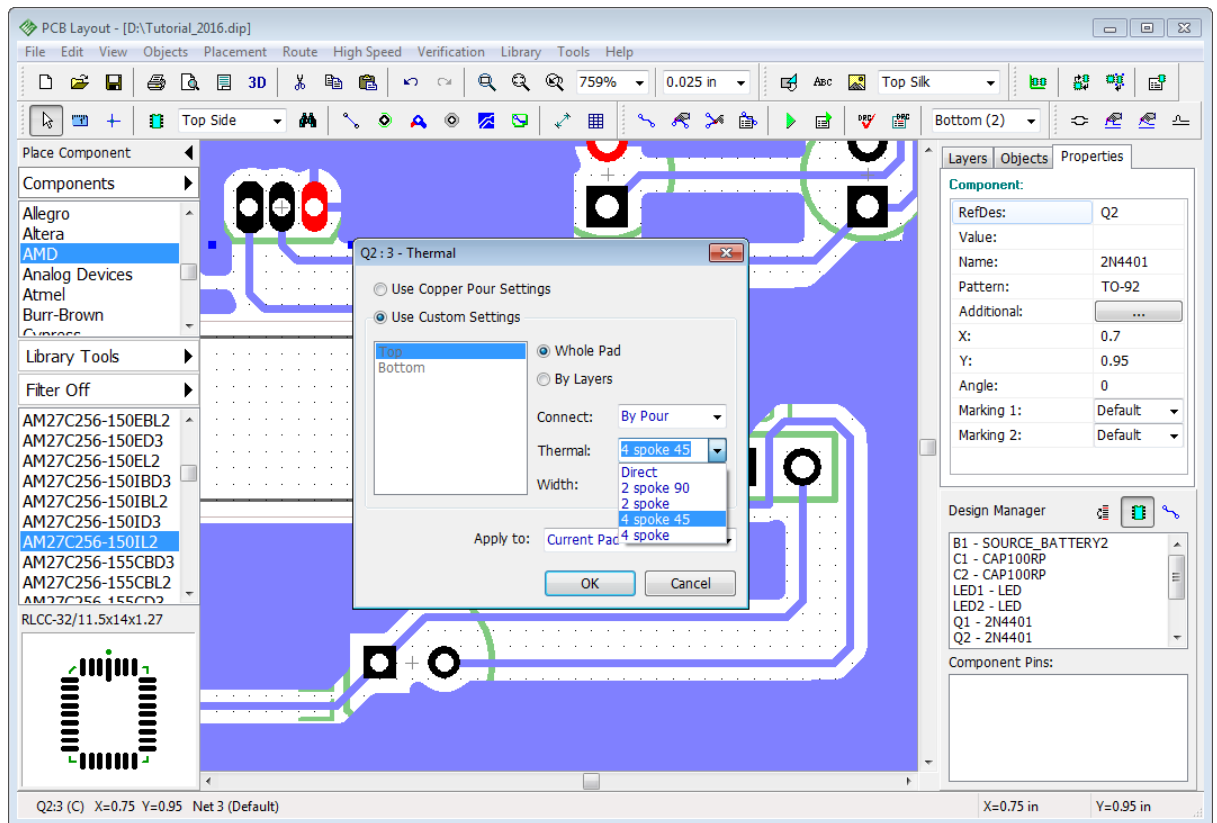

After changing thermal settings click **OK** to close the dialog box, then right-click on the copper pour border, and choose **Update** from the submenu to see these changes applied.

Select "Objects \ Update All Copper Pours" from the main menu to update all copper pours at a time.

We'll try different thermals for pads to show you how it works.

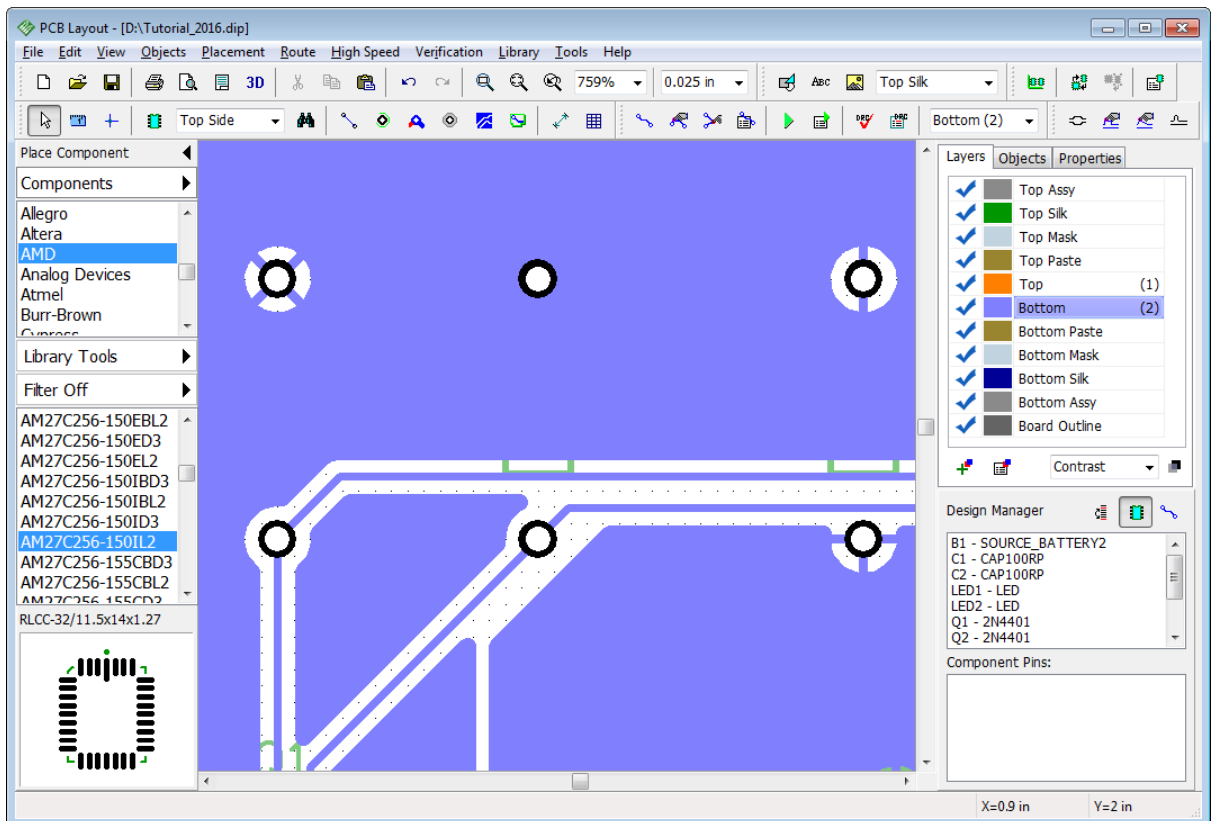

In the picture above, you can see that one pad has 4-Spoke 45-degrees thermal, another one is connected directly, and the third pad has 2-spoke 90-degrees thermal connection.

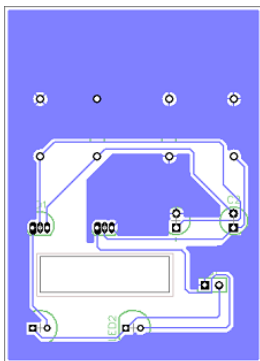

When the copper pours are used as Ground and Power planes, SMD vias usually connect to them by fanouts. You can create fanouts manually with the [Fanout](#)<sup>[208]</sup> feature or automatically by [Shape Router](#)<sup>[38]</sup>.

We have decided to remove all unconnected parts of both copper pours. Go to the **Properties** of each copper pour and check **Unconnected** item in the **Island Removal** section of the **Pouring** tab. Press **OK**. Save the project.

## 2.12 Locking objects

Sometimes while making changes to the schematic or PCB, you need to lock some objects so you don't change them accidentally. Let's see how to do this in the DipTrace.

Switch to the Top layer, select several objects, right-click on one of them, and click **Lock Selected** from the submenu.

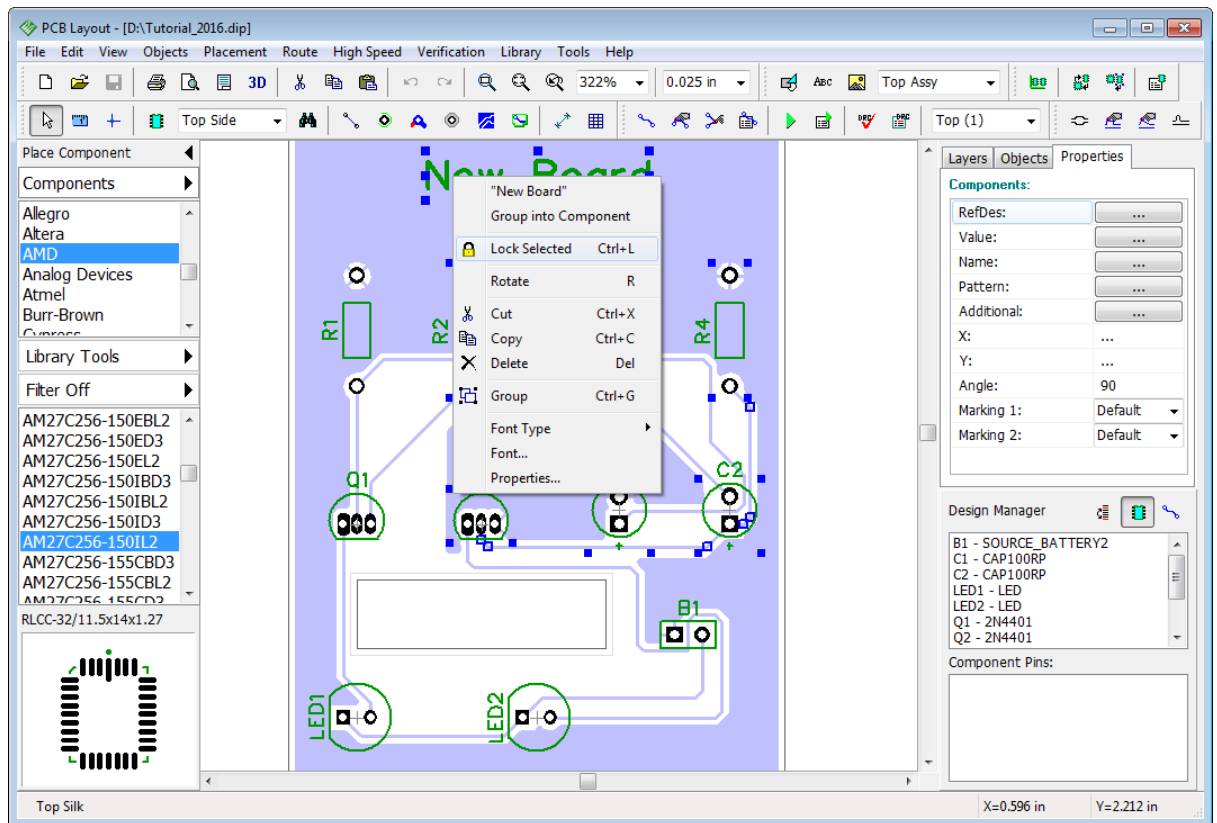

Notice that locked objects have their selection rectangles in lower contrast (in our case color is similar to the copper pour, so we've made only current layer visible (with the drop-down list on the **Layers** panel). "Locked" text appears in the hint of the locked objects, you are unable to move, resize or edit them without unlocking first.

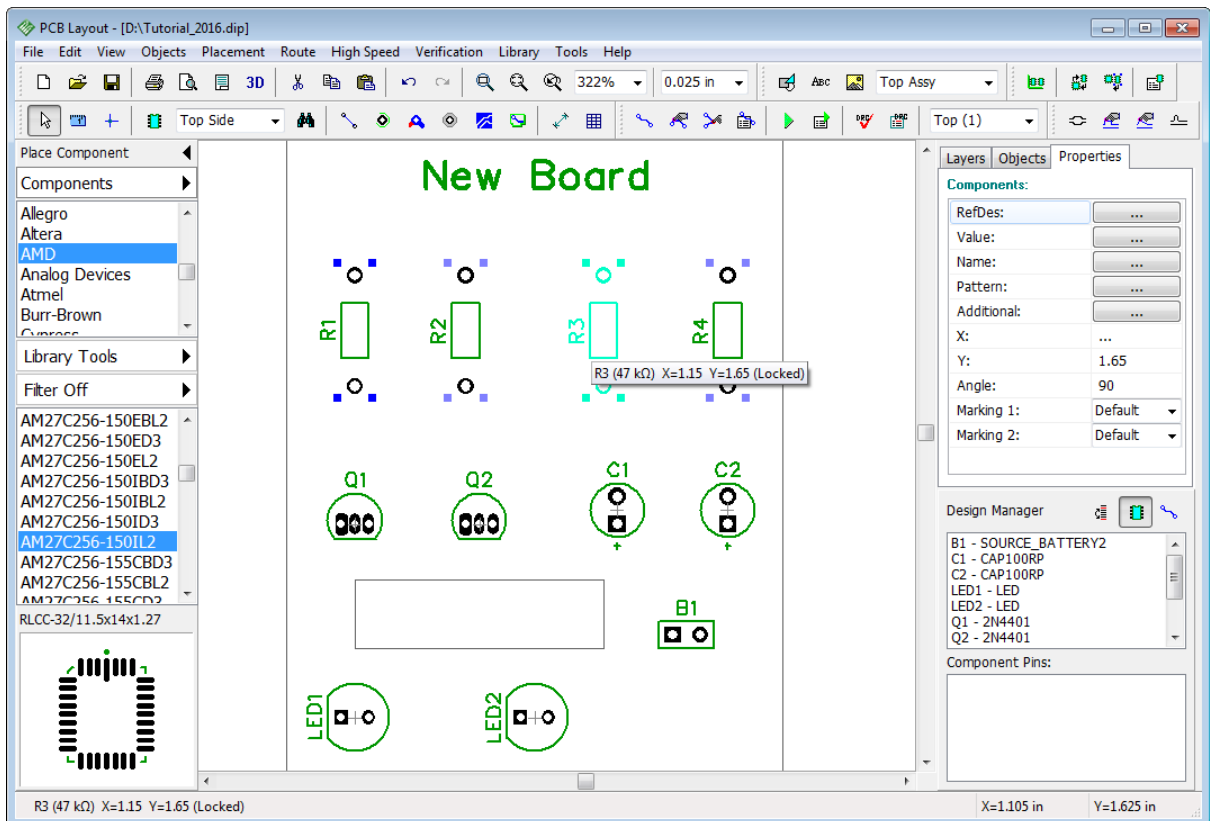

Now please unlock all objects, select all with *Ctrl+A*, and unlock ("Edit \ Unlock Selected" from the main menu or *Ctrl+Alt+L* keyboard combination).

You can lock components after placing them on top or bottom side of the board. Select "Edit \ Lock Components \ Top" to lock top components. Using this mode you can do the routing and not worry about accidentally changing something. Select "Edit \ Unlock Selected" from the main menu to unlock components on the board, then return to the contrast layer display mode using the drop-down on the **Layers** tab (Design Manager).

## 2.13 Design verification

DipTrace has several verification procedures united in the **Verification** main menu item. We recommend to use all three of them: **DRC**, **Net Connectivity Check**, and **Compare PCB to Schematic**.

### DRC (Design Rules Check)

This feature is one of the most important verifications. It allows the user to check clearances between the objects, allowable object sizes, and differential pair parameters according to the set of design rules. DRC works in regular (offline) and real-time modes. Real-time DRC checks all user's actions on the go. For example, when you move some component or create a new trace too close to another object, Real-time DRC shows red circles, which mean that the clearance between these objects (trace, pad, copper pour) is smaller than the specified target value. If the Real-time DRC is completely turned OFF, you would not see errors until you start DRC manually in the regular mode by selecting "Verification \ Check Design Rules" from the main menu or by pressing the *F9* hotkey. Error list or "No Errors Found" message will pop up. Most likely current PCB doesn't have any errors because it is very simple.

Now select "Verification \ Design Rules" to setup design constraints. There are four tabs in

the pop-up dialog box: Clearances, Sizes, Real-time DRC, and Options.

**Clearances.** Specify object-to-object clearances. Uncheck **All Layers** item, select layer from the list below, and define object-to-object clearances applicable on a particular PCB layer.

*Notice that clearance settings are NOT applied to nets with custom net class clearance (Use **Clearance in DRC** option in [Net Classes](#) dialog box is checked) or Class-to-Class settings.*

Check **Same Net Clearance** checkbox, and enter respective values, if you want to check the clearances between certain objects of the same net.

**Sizes.** Specify minimum and maximum allowed sizes for different objects on different layers.

**Real-time DRC.** Customize real-time DRC. You can turn it ON/OFF for specific actions, for example, manual routing, creating / editing, and moving objects. If you uncheck **Enable Real-time DRC** item, real-time verification will be completely turned OFF. But if you uncheck all secondary items in the corresponding tab, and leave only **Enable Real-Time DRC** item active, you will see errors right after completing a certain action, not while performing it. For example, if **Moving objects** item is checked, you will see errors before moving component to a new location, if this option is unchecked – you will see errors right after moving it, still no need to launch DRC separately. If **Enable Real-Time DRC** is unchecked, you would not see any errors, unless you start DRC manually.

**Options.** Setup other options.

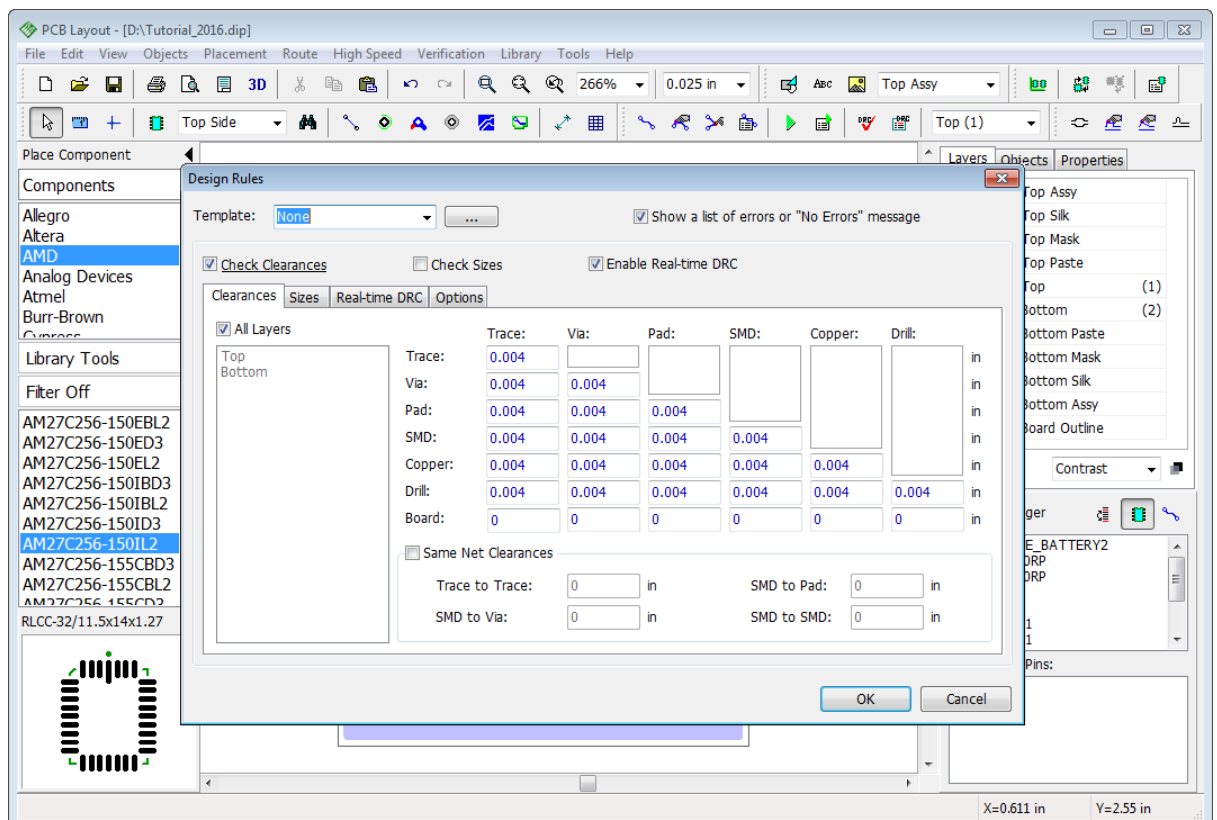

For this tutorial example, please turn OFF the size verification and Real-time DRC by unchecking the corresponding items. Make sure that **Check clearances** and **Show a list of errors...** checkboxes are checked. Keep settings like in the picture above (these values are quite small, but still within technical capabilities of most PCB houses).

Open the **Options** tab and make sure that Class-to-Class Rules, Trace by Length, Copper Pours, or whatever objects you want to be verified are checked. Now let's try to see how DRC works in regular mode. Even if the real-time DRC was ON during the design process, we recommend verifying project with regular-mode DRC at least once before exporting to Gerbers, just to make sure that everything is fine. Press **OK** to apply changes and close the dialog box.

Our project does not have errors, therefore we will create them intentionally. Select Bottom layer ("B" hotkey), switch OFF the grid (*F11* hotkey), and move some trace until it touches the copper pour or another trace. Go to "Verification \ Check Design Rules" or just press *F9* hotkey to launch DRC. The list of errors will pop up automatically.

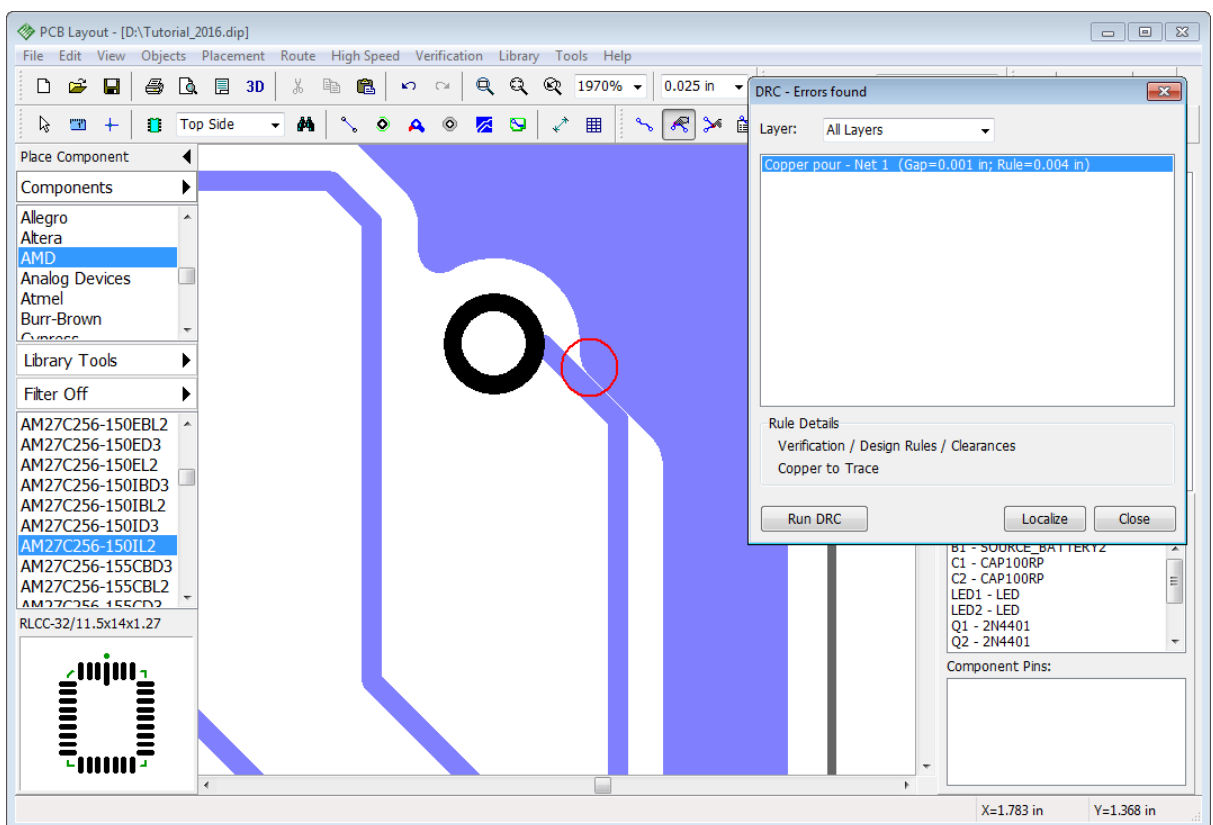

Errors can be sorted by layers. You can see the description of each error including current value and a target value. Left click on the error in the list and DipTrace will show where to change the target constraint in the Rule Details section. Press **Localize** to see selected error on the design area and fix it. Red circle means a clearance error, magenta circle – size error.

Move trace back to its original location without closing the error-report dialog, and then press **Run DRC** button. This time everything is good and **No Errors Found** message appears.

### Net connectivity check

This verification allows the user to check if all nets are properly connected. For such simple design this feature is not necessary, but if you have a larger board with many layers, pins, copper pours, and shapes, net connectivity verification becomes really useful. It checks entire design and displays the list of broken and merged nets. Please select "Verification \ Check Net Connectivity" from the main menu, and click **OK** in the pop-up dialog box. Most probably, your design will not have connectivity errors and you will see the No Errors message. More information about [Net connectivity check](#)<sup>[229]</sup>.

## Comparing to Schematic

This procedure allows you to check if PCB corresponds to the source Schematic file. Verification shows the net structure errors and unknown components. Select "Verification \ Compare to Schematic" from the main menu then choose source Schematic file, and press **OK**. If your net structure was not changed and has no errors, you will see the "No Errors Found" message, otherwise, the list of errors will pop up.

Net connectivity check and Comparing to Schematic features work fast and provide an easy-to-understand user interface with reliable functionality.

## 2.14 Layout information

How about counting the number of pins or the board area? Select "File \ Layout Information" from the main menu in the PCB Layout module.

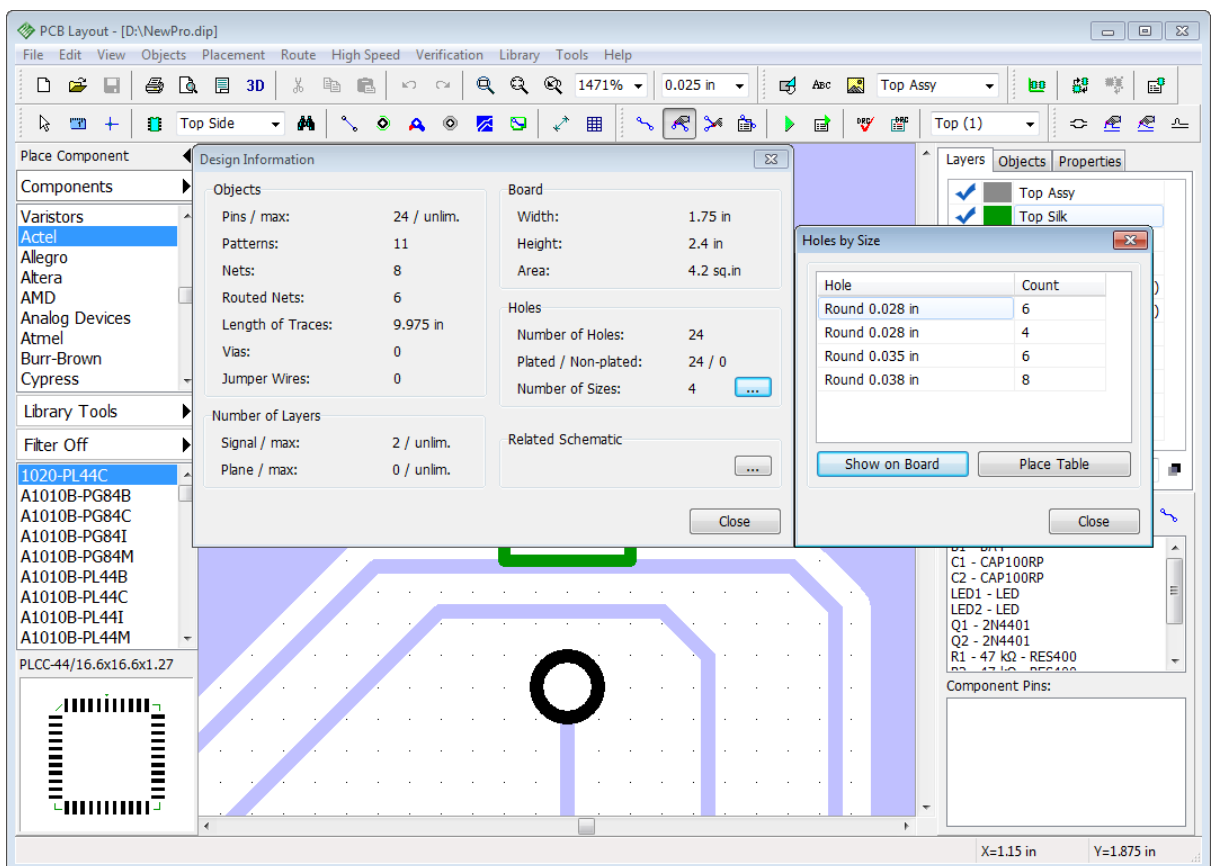

Here you can preview the number of different objects, layers, board and hole sizes. Press **...** button in the **Holes** section to open the **Holes by Size** dialog box. Press **Show on Board** button to highlight holes by size directly on the design area.



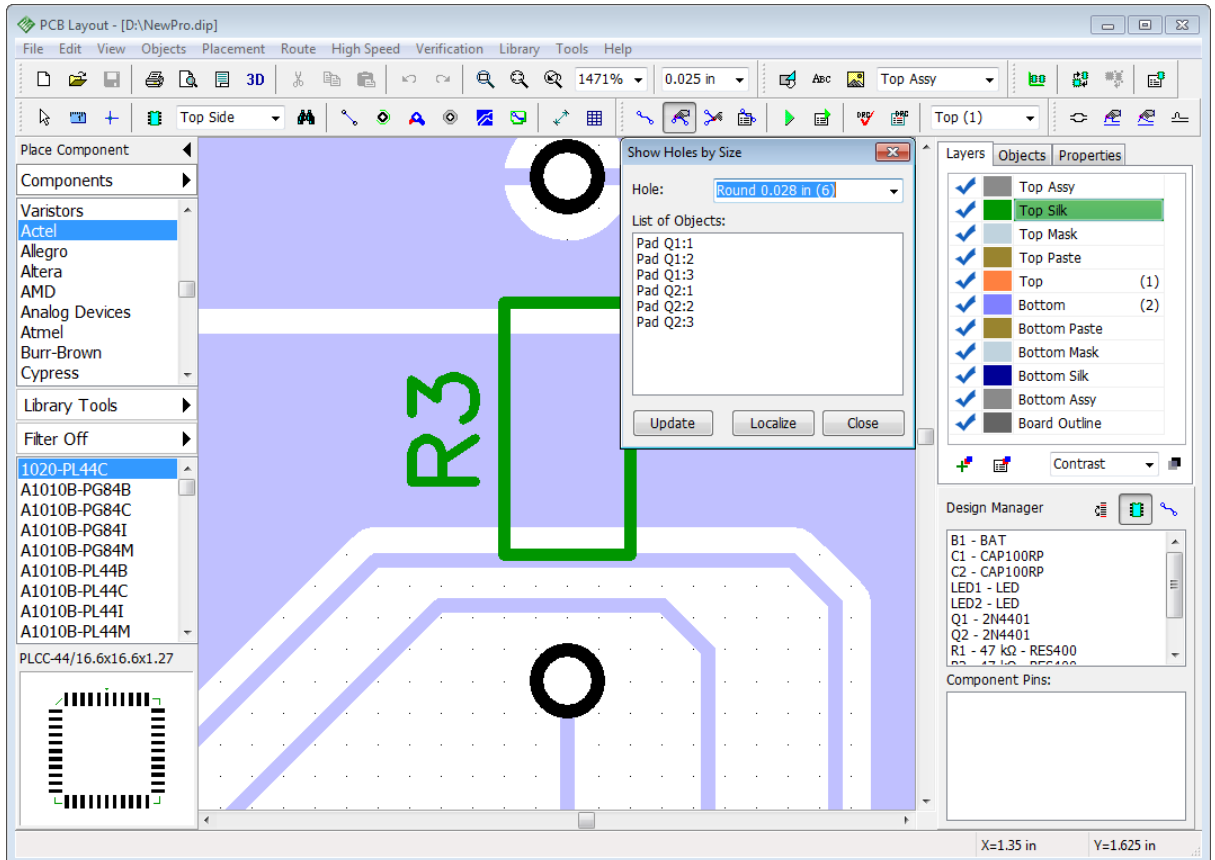

Close the dialog box, and save the layout.

## 2.15 Panelizing

With DipTrace you can panelize similar or different boards on a single layout.

### Panelize project

If you need several copies of the same PCB, select "Edit \ Panelizing" from the main menu.

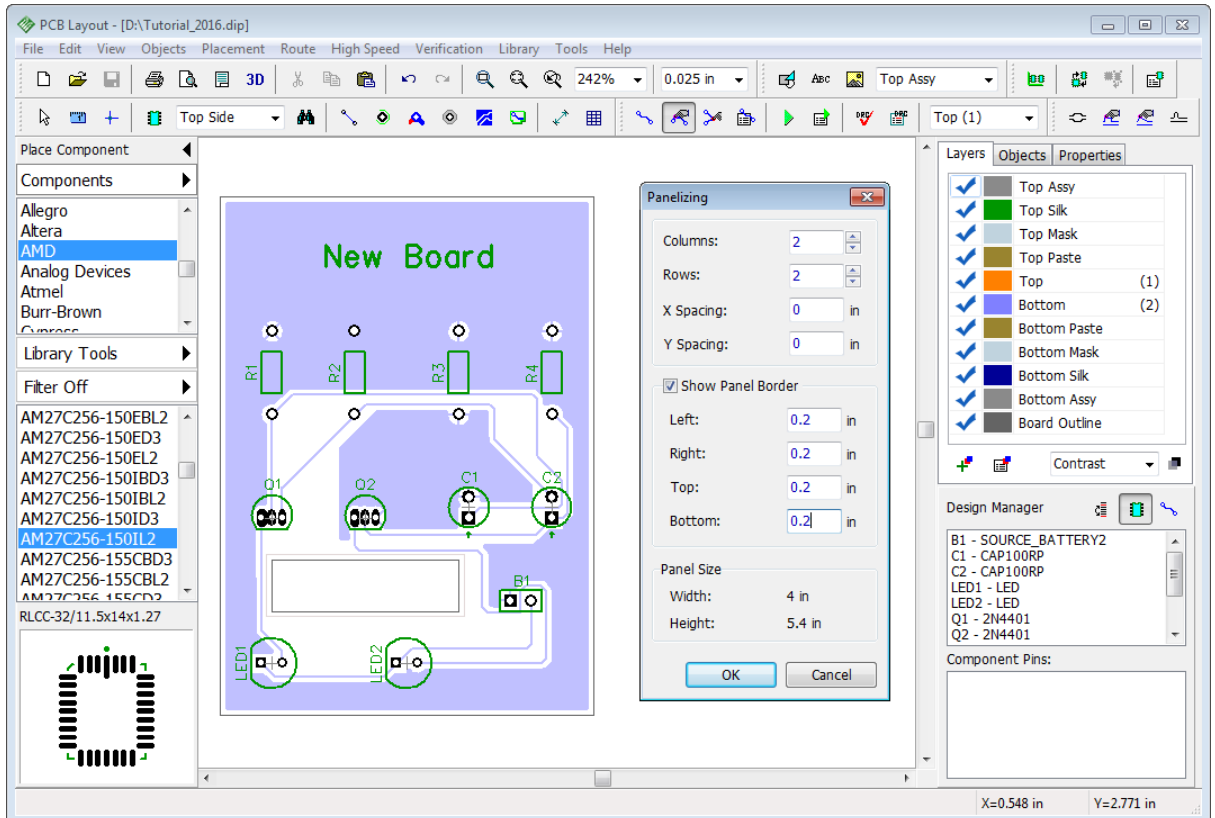

We will make 4 copies of this circuit board, 2 columns and 2 rows. Spacings between the boards will be zero. Showing the panel border may help us to determine the approximate PCB panel size. Board to panel border distance (sometimes called "rail edges") will be 0.2 in for all sides. Some manufacturers need panel border in the board outline layer, so we will also check the **Show Panel Border** checkbox. Click **OK**.

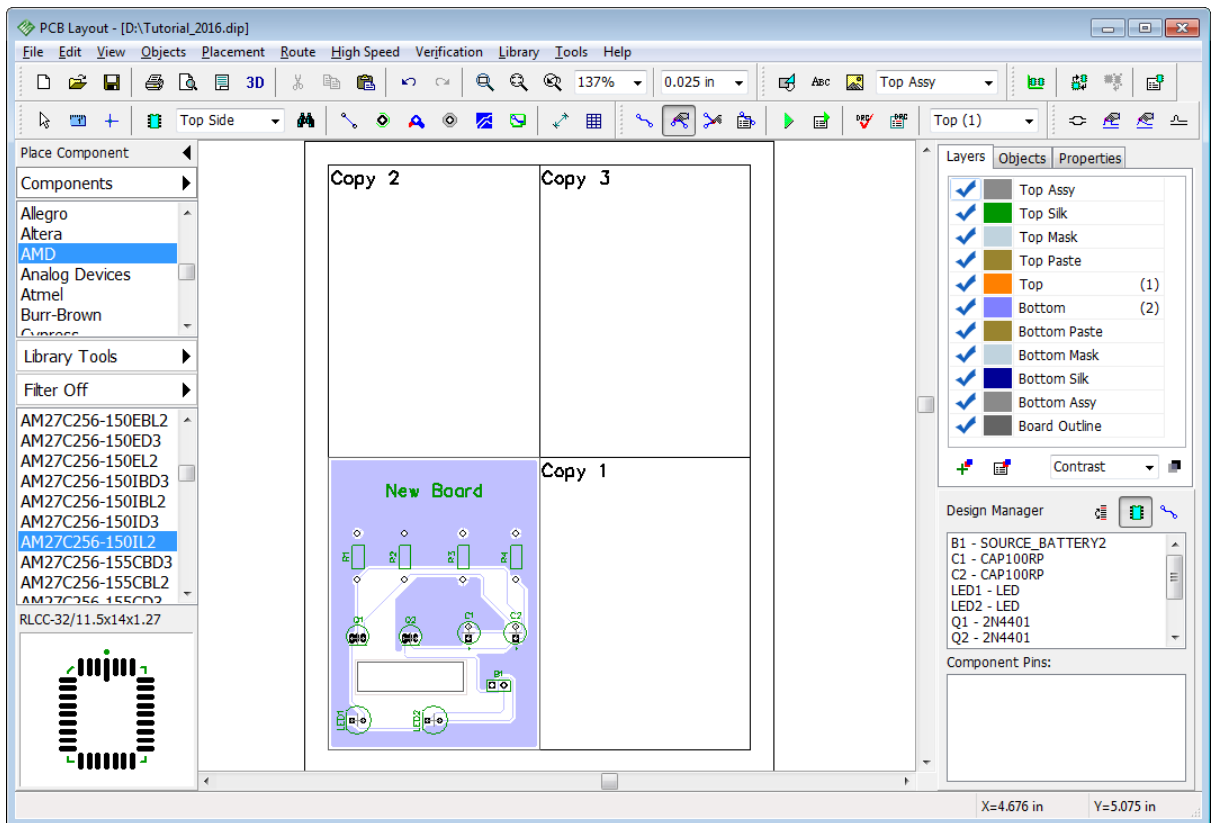

We can see only boxes with "Copy #" text on the design area, but in the Print Preview dialog box ("File \ Preview" from the main menu), while printing or exporting to manufacturing formats, you will see a final layout.

It is possible to exclude some objects from panelizing (for example, holes or shapes). To exclude any object from panelization, right-click it, and check **Do Not Panelize**. This item is available only if Panelizing is active.

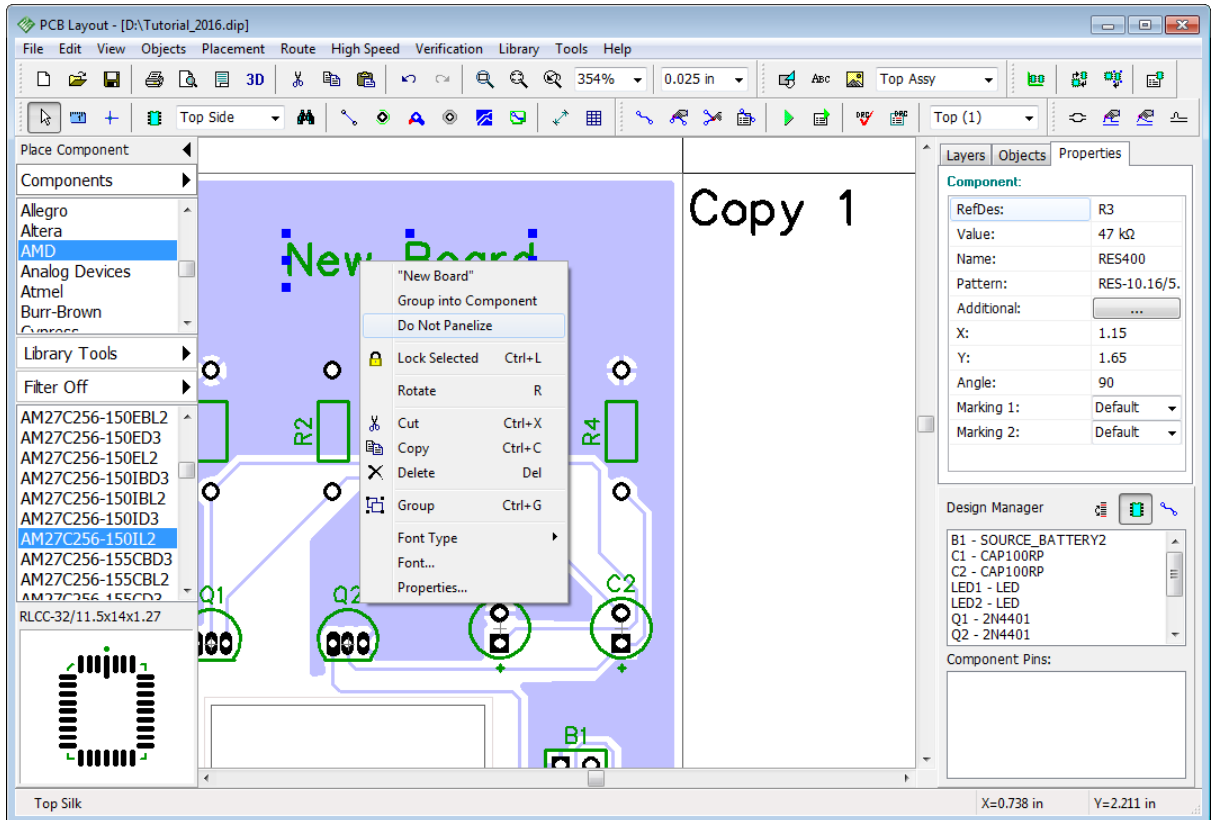

*Notice that panelizing works only if PCB has a board outline.*

Now open the **Panelizing** dialog box and change the number of columns and rows to "1" to remove copies and let us practice with panelizing different boards on a single layout.

### Panelize different projects

Check "Edit \ Keep RefDes while Pasting" item from the main menu, then select all objects ( *Ctrl+A*) of your second layout, and press *Ctrl+C* to copy them, then right-click on empty spot on the design area (this will be an upper-left corner of the second board), and select **Paste** from the submenu.

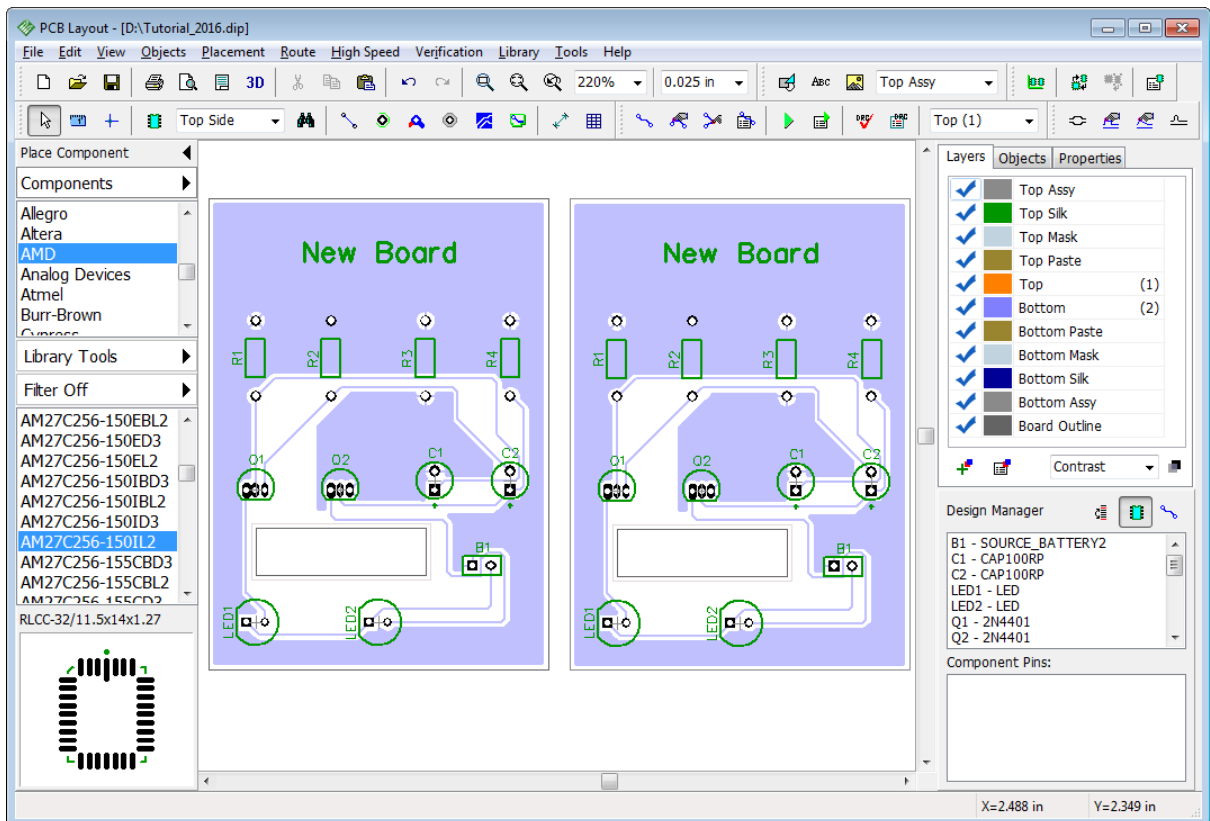

We got the second copy of our PCB (but it can be a different PCB if you want). Reference designators will not change.

*Notice that you need to create a common board outline, board cutouts, and additional non-signal layers may be required for correct manufacturing.*

If **Keep RefDes while Pasting** item is checked, pin limitation of your DipTrace edition (Free, Lite, Standard, Extended) does not apply, so you can easily panelize several 300 pin layouts even with DipTrace Freeware.

## 2.16 Printing

We recommend using the Print Preview dialog box to print PCBs, select "File \ Preview" from the main menu or press  button on the Standard toolbar. Notice that we did not describe creating titles in the **Designing a PCB** section of this tutorial. If you want to display titles, select "File \ Titles and Sheet" from the main menu, and select **ANSI A** in the **Sheet Template** drop-down list, then check **Display Titles**, and close the dialog box before opening the **Print Preview** dialog box.

More detailed information about Titles and Sheets as well as creating and editing titles with the Title Block Editor in the DipTrace Help ("Help \ PCB Layout Help" from the main menu).

Use **Print Scale** drop-down list or Zoom In / Zoom Out buttons to change the scale of the layout on the sheet and press  button to move design on the sheet.

In the upper-left, you can select current Signal/Plane layer and layer display mode. If you want to get a mirrored PCB or text, check **Mirror** or **Flip Text** checkboxes (the Flip Text box is disabled if "View \ Flip Text Automatically" main menu option is ON).

Press **Print** button to print the layout. Press **Save** if you want to save an image to BMP or JPEG file. The small button with colors to the left from the "Zoom Out" tool allows the user to define print colors ("View \ Colors...\ Print Colors" from the main menu).

*Notice that only layers with default color depend on the color scheme.*

For printing all in black and white without changing layer colors, check **Print in Black only** box.

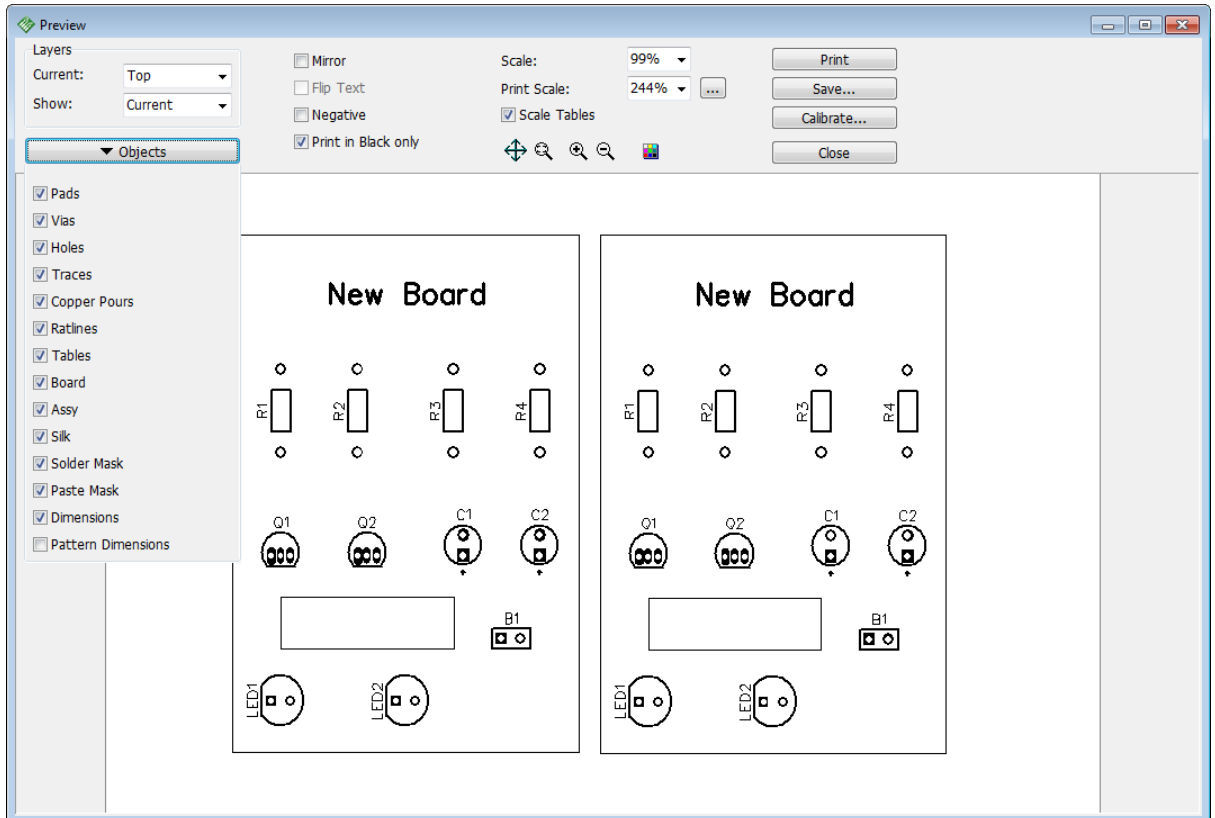

**For hobbyist's attention.** Be aware that laser printers often introduce some degree of dimensional distortion due to heat expansion of the paper. It depends on your laser printer and the quality of the paper used. For most people, it's not important. However, one way to cope with this issue is to preheat paper by running it through the printer, without printing on it (for example, you can print just a dot in the corner). For ink-jet printers, this is not an issue since ink-jet technology does not heat paper. Laser printers do not always visibly distort images but you have to be ready that this can happen. You can use the **Calibration** feature in the **Print Preview** dialog box to minimize heat distortions.

There are two methods of prototyping a PCB at home: using a TT (Toner Transfer) or UV exposure. TT is definitely a method for a laser printer, and UV exposure is better with ink-jet printers.

Close the Print Preview dialog box and **Undo** several times to remove the second PCB and return the board without panelization. Then save the layout.

## Part III: Generating files for manufacturing

### 3.1 DXF

DXF output allows for exporting data to many CAD / CAM programs which support DXF import (AutoCAD and others).

#### DXF export

To export the circuit board to DXF format, select "File \ Export \ DXF" from the main menu, select layer from the list of all layers, and check/uncheck the corresponding boxes to show/hide different objects on this layer (text, pictures, vias, etc.). Set up the offset (distance between zero and the bottom-left corner of the board: design origin or custom value), mask and paste layers if needed. You can save each layer into a separate DXF file, but in order to export entire board into a single multi-layer DXF, press **Select All** button.

*Notice that "Edge\_Top" and "Edge\_Bottom" are not selected. Technically these are not the physical layers of your circuit board. They are exported only if you are going to manufacture the board with milling method.*

Press **Export** button, specify the name of the file, location, and save the circuit board into a DXF file.

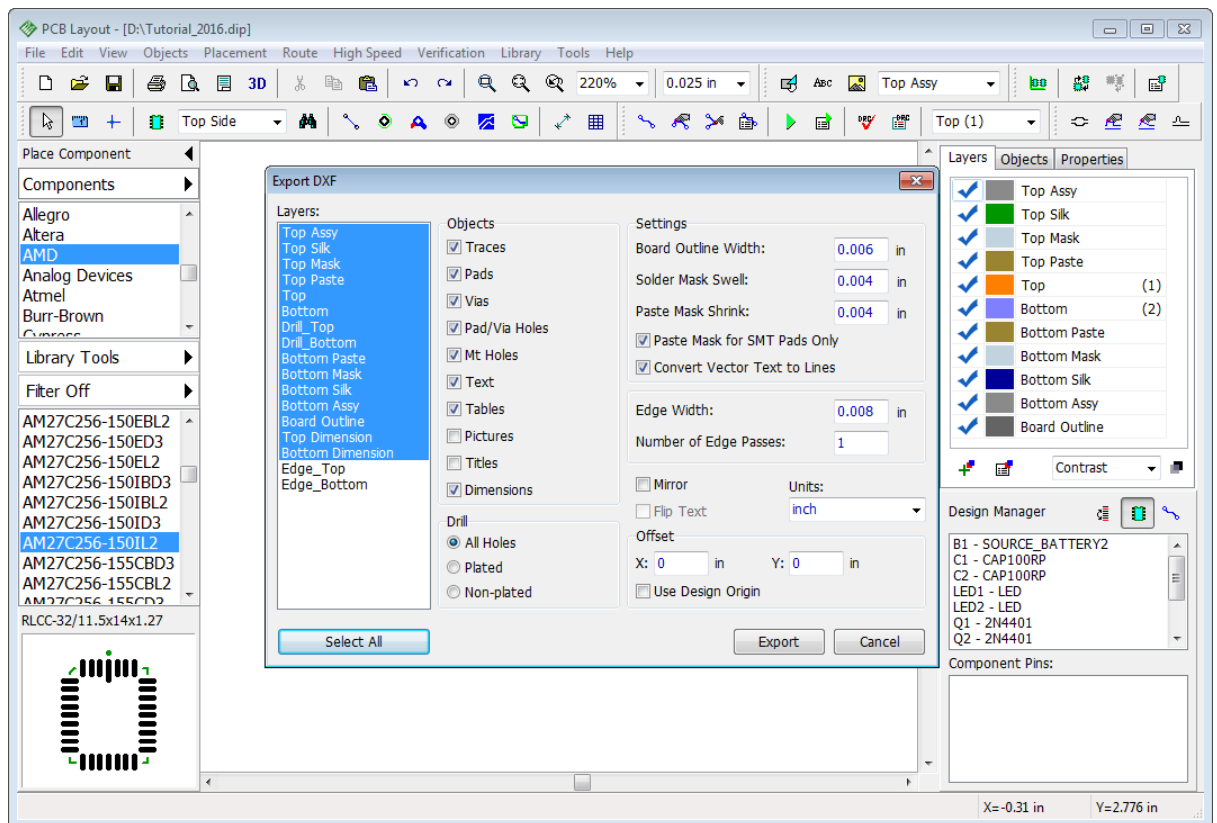

All layers of the board will be exported into a single DXF file. You can open it with AutoCAD or another program that reads AutoCAD DXF.

#### Export for milling (DXF and G-Code)

Milling method is convenient and cheap for non-complex boards.

*Notice that copper pours (unlike thermals) are not considered when exporting edges for milling.*

Select "File \ Export \ DXF" to open the **DXF Export** dialog box, then select **Edge\_Bottom** layer, because all traces of our PCB are on the Bottom layer (if you have traces in the top layer, select Edge\_top), check **Mirror** checkbox to mirror the design (for the bottom layer). This will allow us to see the actual bottom side of the board. You can leave default values if you're not familiar with specific milling settings or define the **Edge Width** parameter. Center line of the milling will be calculated as a half of the Edge Width value. Milling depth depends on the edge width and the instrument angle.

Press **Export** button, and save the DXF file.

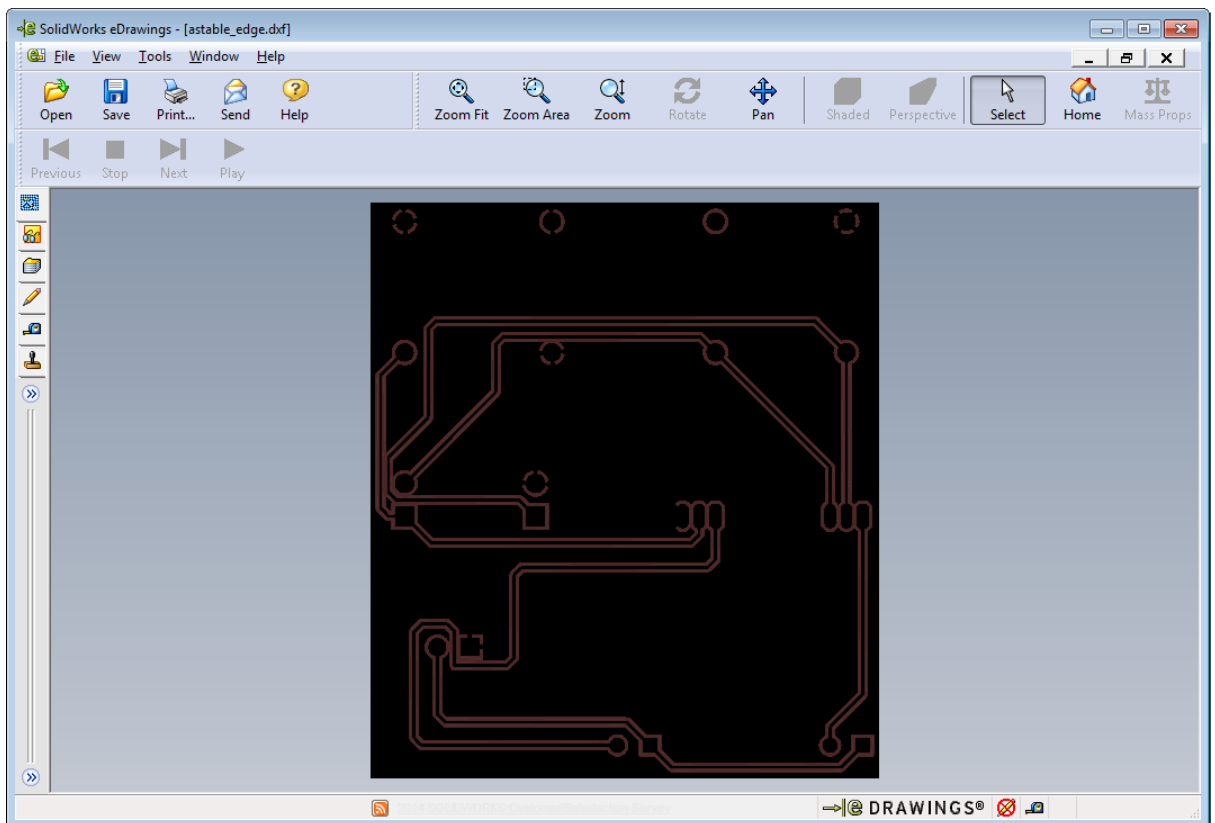

The edge exported from the DipTrace is a set of polylines with defined width. DipTrace checks design before export and if object-to-object clearances are less than the edge width, DipTrace shows a warning message and enables the designer to correct errors.

Notice that CAD programs usually show polylines with sharp angles, but when you mill the board or simulate milling with a CAM program, everything will look rounded because of the instrument radius.

CNC drilling machines work with G-Code files. Convert your edge from the DXF format to G-Code, using [ACE converter](#), [FlatCAM](#) (both are free) or another software.

Please **Undo** several times to return the copper pour if you deleted one.

## 3.2 Gerber RS-274X

DipTrace allows the user to export a circuit board to Gerber format, accepted by almost all PCB manufacturers around the world.



Select "File \ Export \ Gerber..." from the main menu. In the **Export Gerber** dialog box you need to select layers which you are going to export (use *Ctrl* and *Shift* for multiple selections), specify which objects will be exported to Gerber for each layer (select layer from the list and use the corresponding checkboxes in the Objects section).

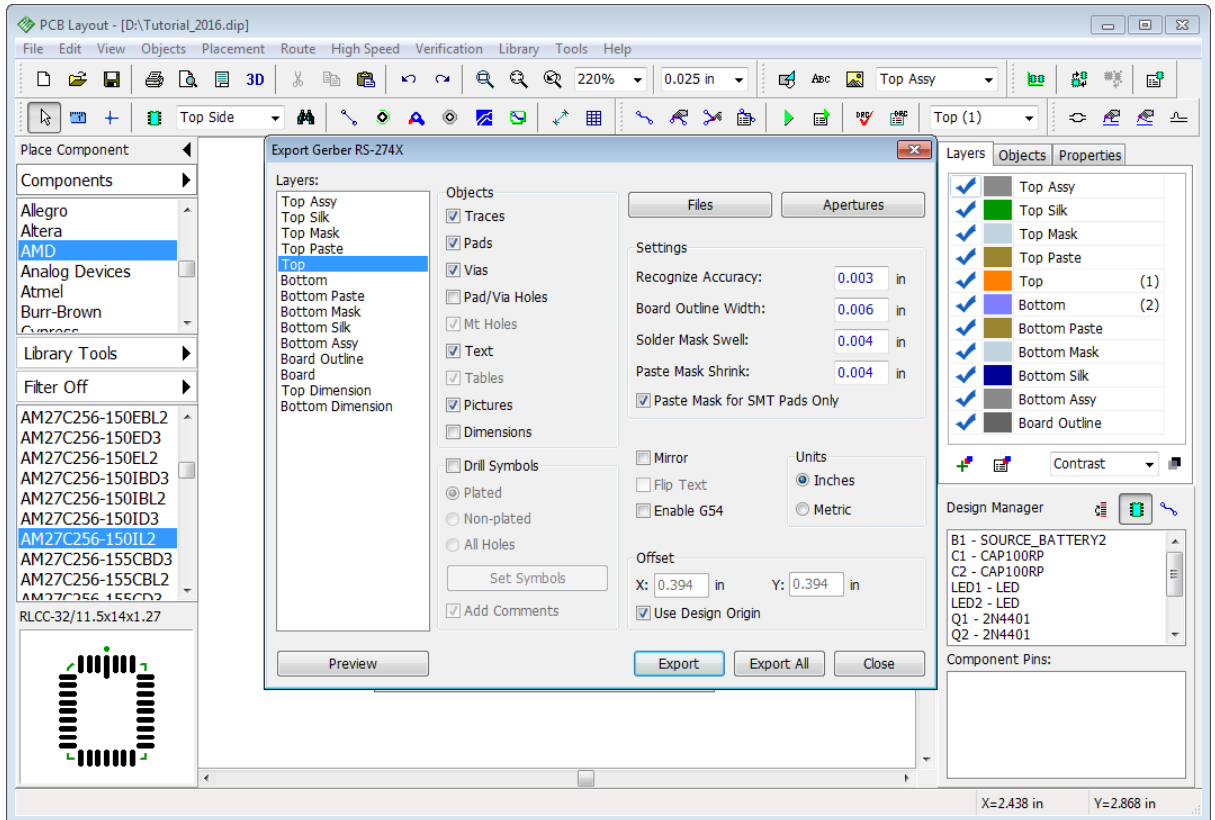

Press the **Preview** button to preview selected layer. Unlike DXF, all layers should be exported to Gerber format separately, one layer per file. The image below shows the bottom layer of our PCB in the Gerber preview dialog box. You can zoom in and out. Press **Close** button to close the preview dialog box.

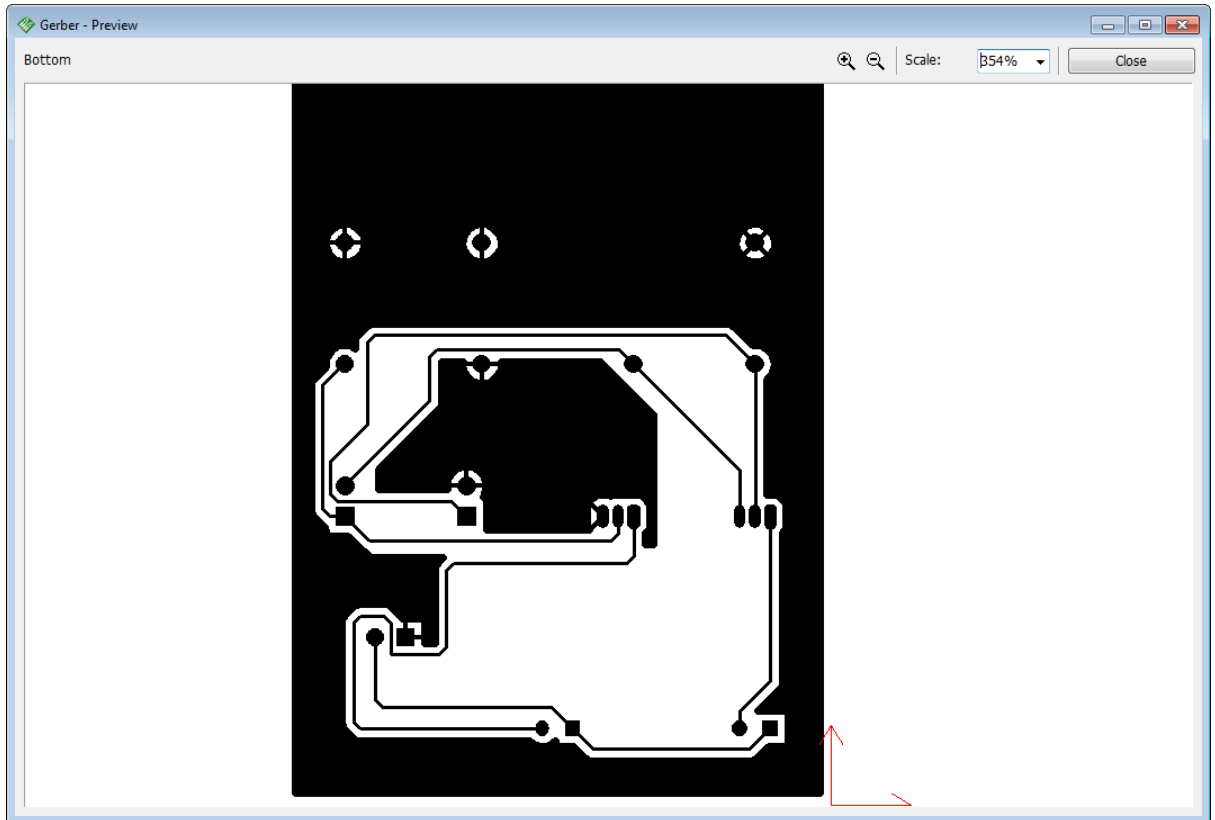

Press **Export All** and DipTrace will generate files for each layer automatically. Remember that PCB houses need **Gerber and N/C Drill files**<sup>[90]</sup> to manufacture your PCB. Once you export those, you can archive them for convenience and send out for manufacturing.

### Gerber layers

1. **Top Assy** – this is assembly layer, it includes all shapes/texts placed on the Top Assy as well as objects defined in the "View \ Assembly Layers" main menu item. Assembly layer in this project includes the board outline because it is selected in the "View \ Assembly Layers" main menu item, but you can select another object or hide the board outline on this layer.
2. **Top Silk** – includes pattern shapes, texts and all other shapes and texts placed in the Top Silk layer. Do not change these settings, and press **Preview**. Notice that if you use the TrueType fonts, some parts of the text can be invisible (depends on the font and size), you should make **Recognize Accuracy** value a bit smaller, but do not apply minimums.
3. **Top Mask** – this is a solder mask layer. It is generated automatically, based on pads, custom pad settings, and common Solder Mask Swell parameter, defined in the Export Gerber dialog box. This layer also includes shapes placed in the solder mask layer. We should uncheck the **Vias** box (exclude vias from the export) because vias are usually covered with the solder mask. To change custom solder mask settings for pads, right-click on the pad, and select **Mask \ Paste Settings** from the submenu.
4. **Top Paste** – this layer is used for SMD pads only, so we can check **Paste Mask for SMT Pads only**.
5. **Signal layers** (Top, Bottom, etc.) – these are copper layers. Please check the **Vias** checkbox for all of them and preview each one to make sure that layers are correct.

Notice that **Pad/Via Holes** item in the **Objects** section should be checked only if you plan to

drill holes manually (not using a PCB house). If Pad/Via Holes check box is checked, two Gerber layers will be created inside one Gerber file: Positive Drawing and Hole Clearing. The second layer is used to remove artifacts over the drill holes. Manufacturers prefer Gerber files without pad/via holes.

**6. Bottom Paste, Mask, Silk and Assy** layers are just like their analogs from the top side. By default all text objects in Bottom layers are flipped – "View \ Flip Text Automatically" option from the main menu.

**7. Board Outline** layer includes the board outline with defined width.

**8. Board** layer includes the board as a filled polygon.

**9. Top/Bottom Dimensions** – layers created specially for dimensions. These layers are blank in our case because the current project does not have any dimensions on the design area. Top / Bottom Dimensions can help some manufacturers to avoid mistakes in sizes.

*Notice that NOT all layers are necessary for successful board manufacturing. It depends on your project and additional features that you order.*

### Other settings

The Offset parameter in DXF, Gerber, N/C drill, and Pick and Place export dialog boxes is the distance between the zero and the bottom-left corner of the board. You can use a custom value or design origin (check the corresponding item or enter values in the Offset section of the Gerber export dialog box).

Press the **Files** button in the upper-right corner of the **Export Gerber** dialog box, define filename and extension for each Gerber layer, and include or exclude certain layer/s from exporting when you press the **Export All** button. Select layer in the list, and type in a new name and extension. Layer name and project name tags are supported. We will not change anything, keep the <layer> tag – all files will be named as layers. Press **OK**.

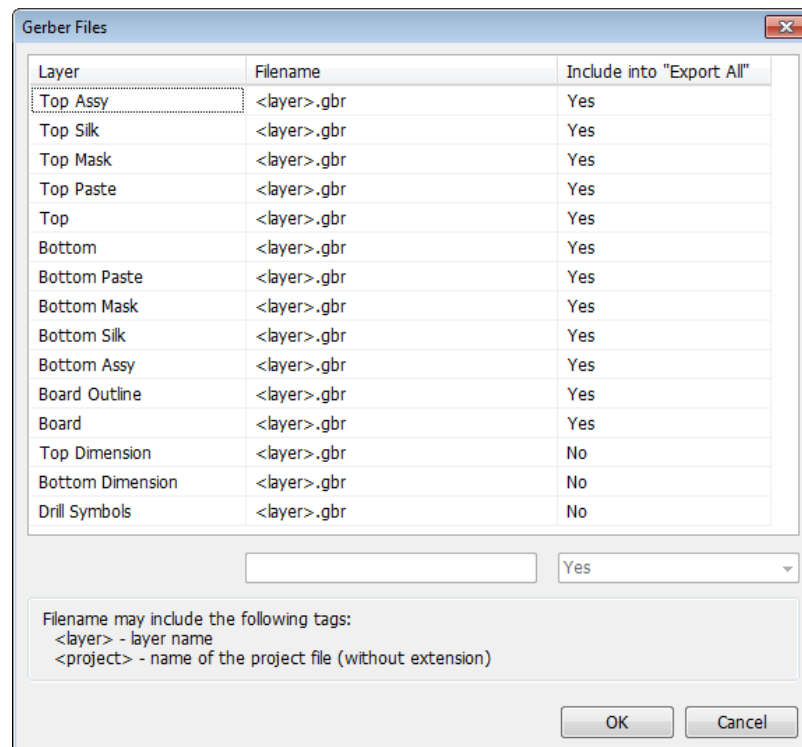

## Drill Symbols (Legend)

Some PCB houses require Drill Symbols. DipTrace allows you to export them as a separate Gerber file. Check the **Drill Symbols** checkbox in the **Export Gerber** dialog box, then press **Set Symbols** button. In the pop-up dialog box, you need to manually assign each hole with the symbol from the list in the right side or press the **Auto** button to assign all symbols automatically. Close this dialog box.

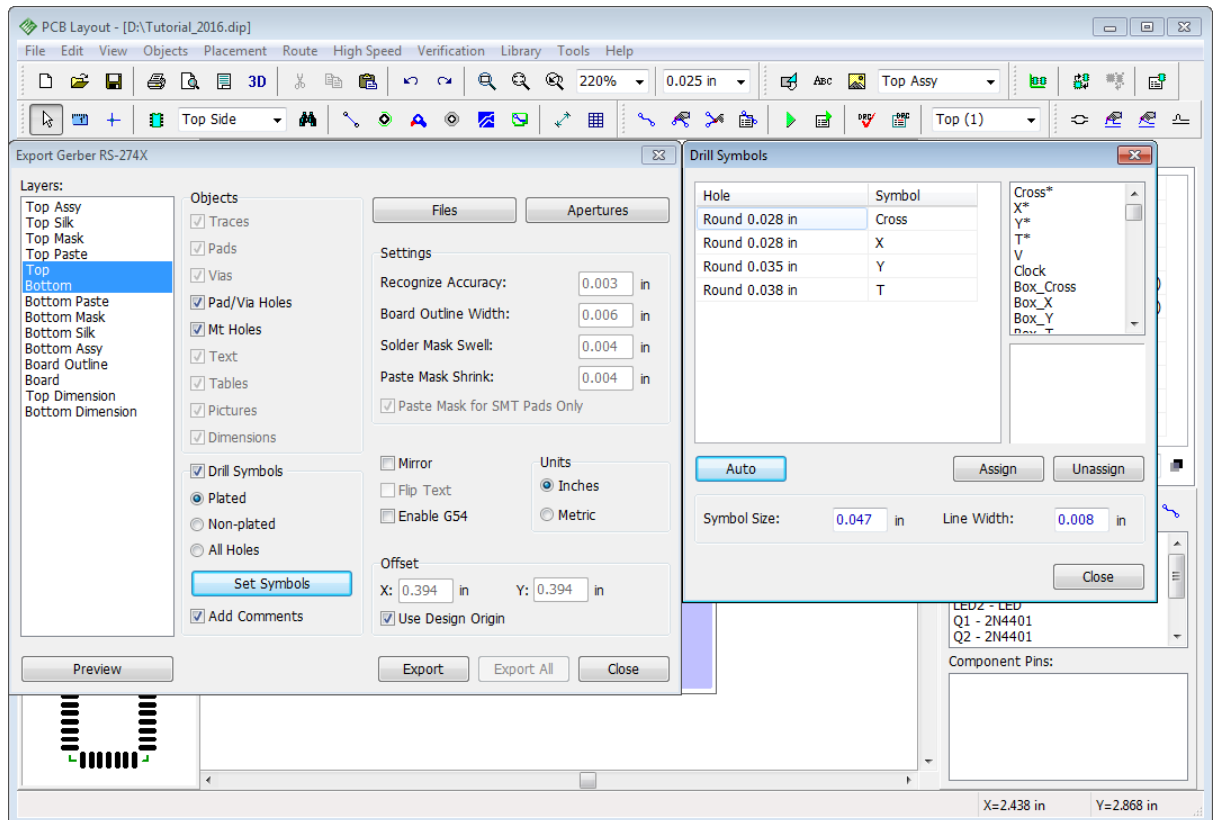

Now check the **Add Comments** checkbox, and press **Preview**. You will see the drill symbols and a table with hole parameters.

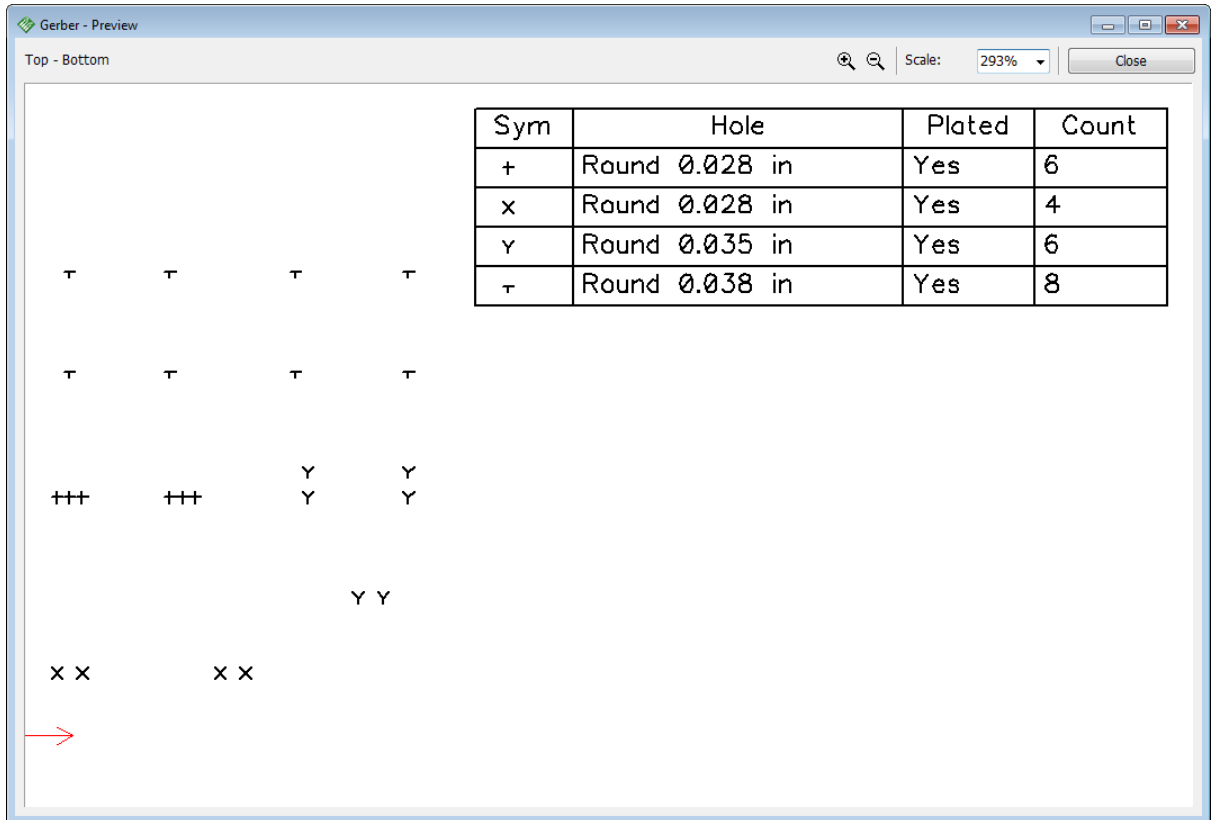

Close the preview panel, and press **Export** to save Drill Symbols in the file. Drill symbols will be exported in the separate file just like any other Gerber layer. If apertures are not defined, DipTrace will ask you to set them automatically.

**Uncheck the Drill Symbols checkbox when done**, otherwise, you will get a blank file/preview while exporting silk, assy, signal layers, etc.

DipTrace allows the user to export any texts, fonts, and Unicode symbols (even Chinese hieroglyphs) as well as raster black and white images (company logo, etc.) to Gerber format, but you should define the **Recognize Accuracy** for such objects. 3 mil is set by default, you can use the accuracy of up to 0.5 mil.

We recommend checking Gerber files with third-party viewer, before sending them for manufacturing. The best option is to use the same software (or a free viewer) as your board manufacturer, because some programs may read Gerber files a bit differently from the official RS-274X specification.

We tried to take into account specifics of different manufacturing software in DipTrace Gerber export feature, but verifying files is a very good practice.

If you don't know what software your manufacturer uses, we recommend [Pentalogix Viewmate](#), it has strict RS-274X conformity.

### 3.3 Gerber X2

Gerber X2 is the latest evolution of the Gerber format and DipTrace was one of the first electronic CAD systems with Gerber X2 support. If your PCB manufacturer accepts Gerber X2 files, you can completely enjoy the benefits that this format gives to an engineer. Gerber X2 stores information about PCB stackup order, a function of each layer, PCB attributes and pad functionality.

Select "File \ Export \ Gerber X2" from the main menu in the PCB Layout. Since Gerber X2 is compatible with [Gerber RS-274X](#)<sup>[84]</sup>, the dialog boxes are very identical and exporting procedures does not differ from the ones described in the [Gerber Output](#)<sup>[84]</sup> topic of this tutorial.

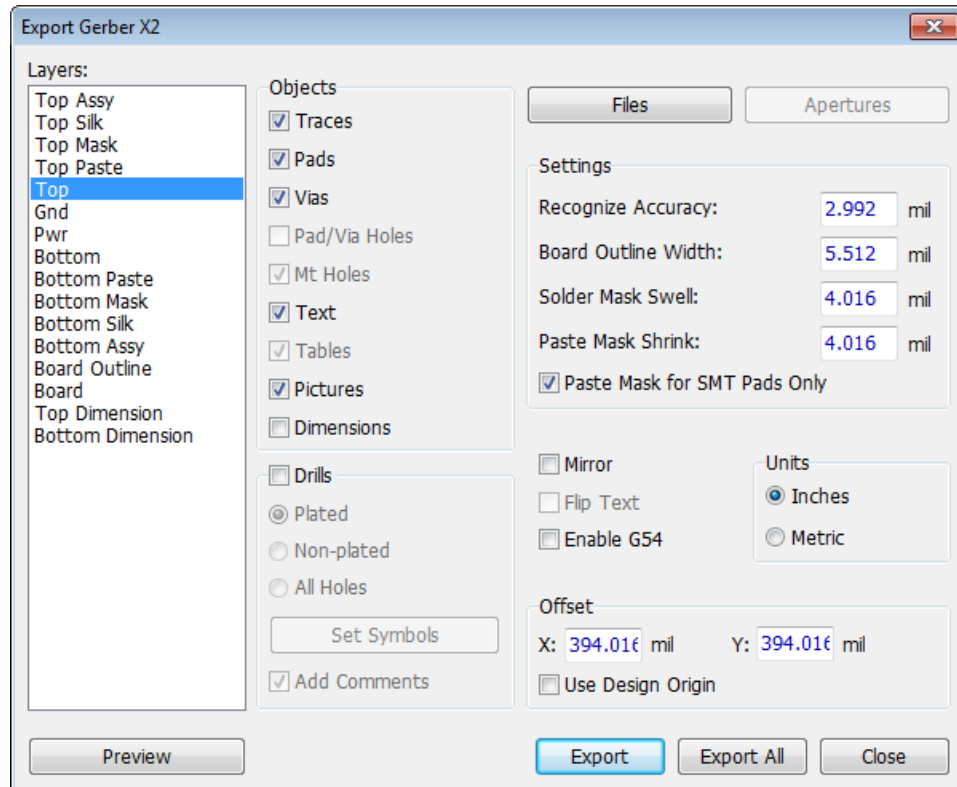

However, Gerber X2 saves comprehensive drill layout in the Gerber-formatted file (not just Drill Symbols, like Gerber RS-274X). To export drills, check the **Drills** checkbox, select all copper layers (they should be selected by default) to export through holes or press **Export All** to export all holes of the project automatically into the corresponding Gerber file/s. Each type of the hole goes into a separate Gerber Drill file.

Check with your PCB house if they accept Gerber X2. Since most of the manufacturers still require drills in the N/C Excellon format, please refer to the [respective topic](#)<sup>[90]</sup> of this tutorial.

### 3.4 N/C Drill file (Excellon)

If you order board manufacturing at a PCB house, you need to provide **Gerber and N/C Drill files** to them. Select "File \ Export \ N/C Drill" from the main menu, then press the **Auto** button to define the tools, and press **Export All** to save all necessary files automatically. Use the **Preview** button to visually check the layout.

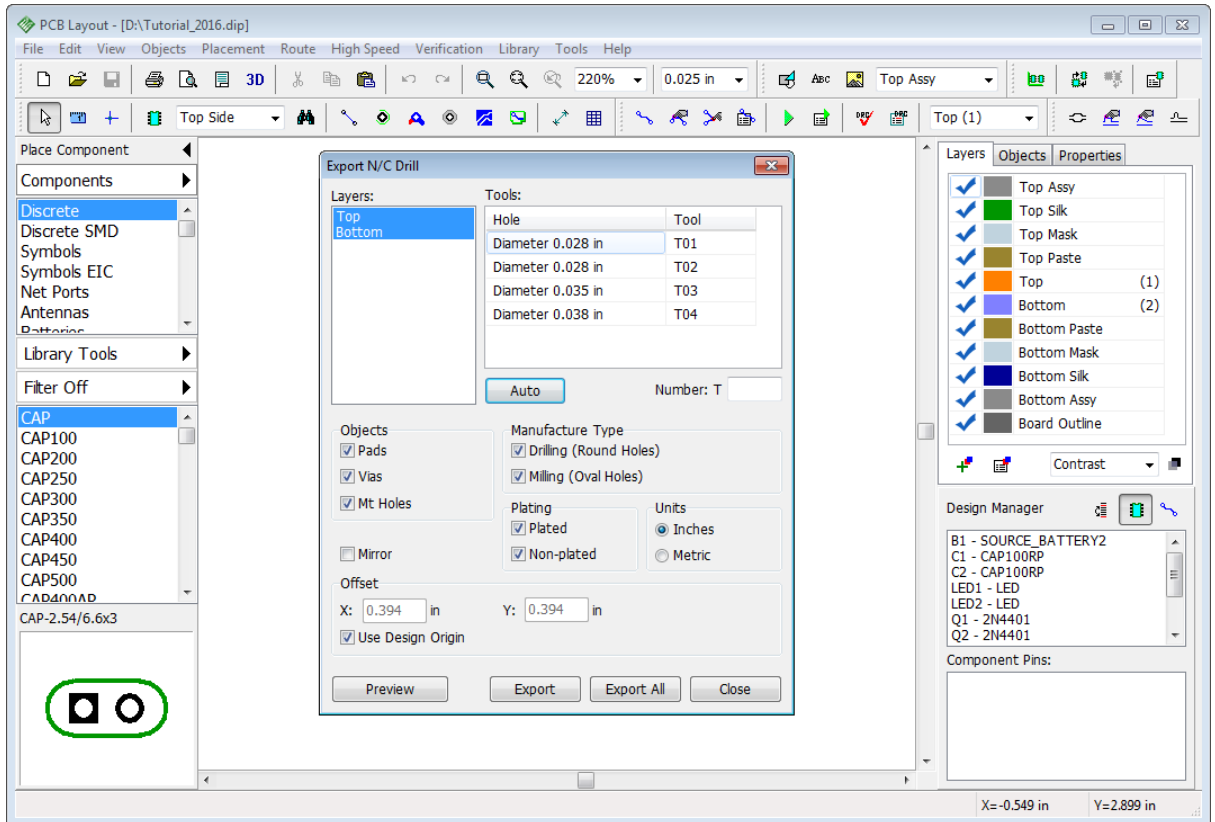

If you want to export just the holes of a certain type separately from the other, select the layer pair of the via style, and press **Export**.

*Notice that for through holes all layers should be selected, for Blind/Buried vias – only top and bottom layers involved in the via style.*

### 3.5 ODB++

DipTrace allows the user to export circuit boards into ODB++ format for manufacturing. Select "File \ Export \ ODB++" from the main menu in the PCB Layout. In the pop-up dialog box you can check or uncheck certain PCB layers for exporting, change default solder mask swell and paste mask parameters with respective fields and checkboxes, edit the offset values, and define an export mode. Default settings usually work for most cases so do not change them unless you need.

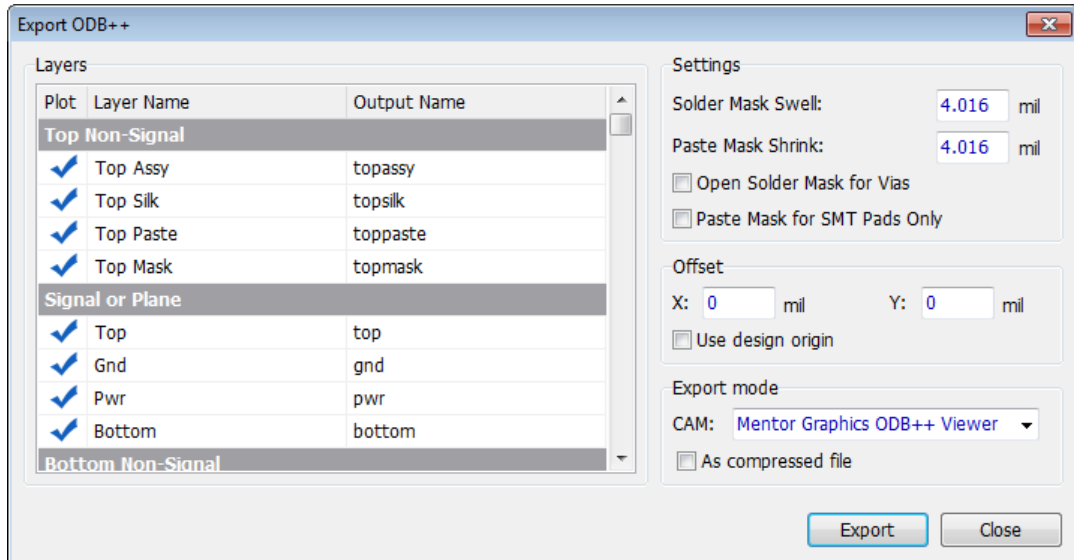

If **As Compressed file** item is checked, DipTrace will zip all ODB++ files into a single file for sending out to the board manufacturer. Press **Export** and specify a folder where to save the output files. You can preview ODB++ files with a free Mentor Graphics ODB++ Viewer.

### 3.6 Order PCB

For those who doesn't want to look for a PCB house to manufacture a circuit board, DipTrace allows for a simple ordering tool with [Bay Area Circuits](#), our partner PCB manufacturer in California. No need to export Gerber or N/C Drill files, enter few details and manufactured board will be delivered to your place. Go to "File \ Order PCB" from the main menu in DipTrace PCB Layout, review the board parameters, specify quantity, manufacturing time, shipping address, name, phone, email, and some additional details. The price will be automatically calculated.

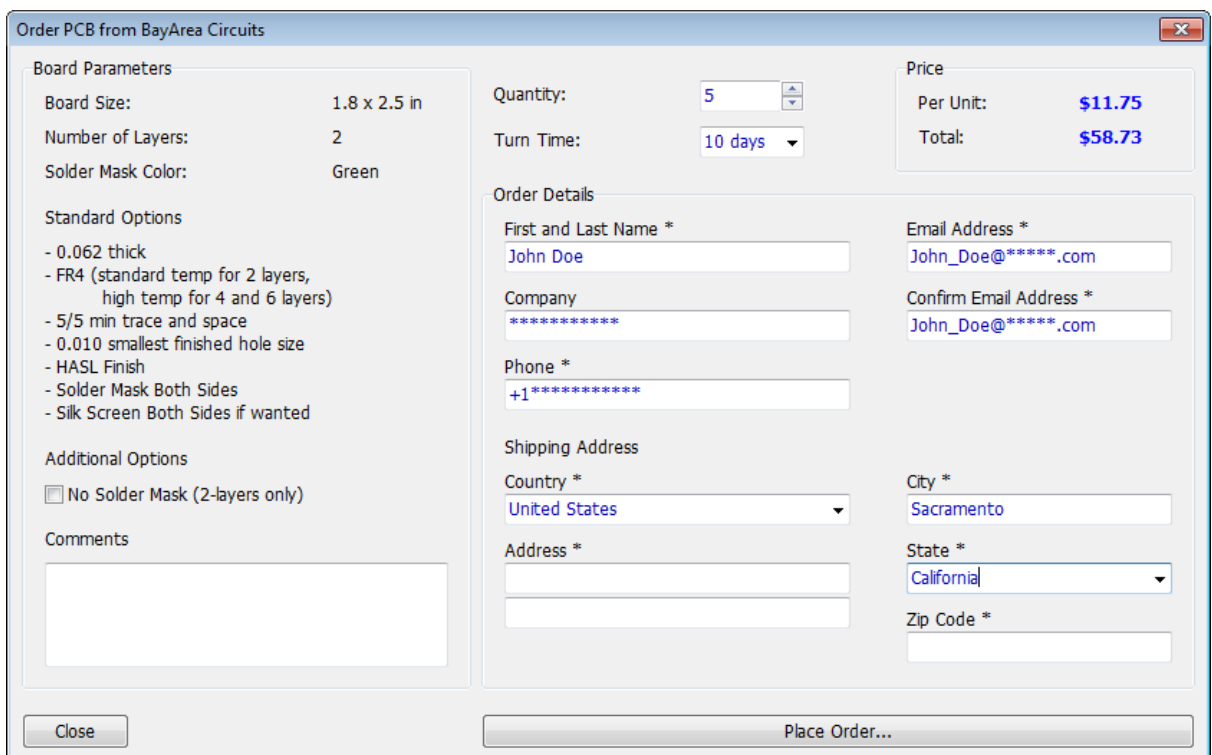



Press **Place Order** button to open the order page in your web browser, review the total cost, including shipping. Online payment via PayPal.

DRC checks your PCB automatically. If there are errors, we recommend to carefully review and fix them. Please do not allow for any ambiguity, especially related to Solder Mask and Solder Paste settings. Describe it in the Comments section, or contact Bay Area Circuits to clarify any of the questions that you think may arise.

**Email: [support@bacircuits.com](mailto:support@bacircuits.com)**

**855-811-1975 FREE (toll free)**

**510-933-9000 (local)**

**510-933-9001 (fax)**

**Corporate Headquarters**

**44358 Old Warm Springs Blvd**

**Fremont, CA 94538**

Congratulations! You have finished designing a simple project with DipTrace.

Please, save your schematic and PCB files if you want. It took longer to read this tutorial than to actually create a project. :-)

P.S. Do not forget to uncheck the **Use Priority Layer Directions** check box in the **Autorouter Setup** dialog box if you plan to route 2+ layer boards.

## Part IV: Creating Component Libraries

In this part of the tutorial we will teach you how to create component and pattern libraries. In most cases you can find appropriate pattern in DipTrace standard libraries and attach it to a new component, but for educational purposes we will create a new pattern from a scratch.

*Important:*

*In this tutorial we often refer to components as patterns or footprints (if talking about the PCB Layout), while in the Schematic components are often called symbols, component symbols, or schematic symbols, all these mean the same physical electronic component.*

*A regular component in DipTrace consists of schematic symbol, pattern drawing and, possibly, a 3D model. All three represent the same entity, but on different stages of the design: schematic capture, PCB Layout, and 3D visualization/export respectively.*

*Components and attached patterns are saved together in the files with \*.eli extension. Components are always stored in libraries. If if you need to create just a single component, you have to create a separate library for it.*

*DipTrace also allows access to patterns separately from the components. Patterns are also stored in libraries. Pattern libraries are saved with \*.lib extension. No surprise, these files are only accessible in the PCB Layout and Pattern Editor.*

*\*.wrl, \*.3ds, \*.iges, and \*.step files store 3D models. Patterns and schematic symbols can exist as separate stand-alone parts, but correct component always have all of them properly connected.*

*Different schematic symbols can have the same pattern (footprint) attached to each of them and vice versa, for example the same resistor can be in through-hole and SMD packages.*

*DipTrace has two separate programs Component Editor and Pattern Editor for designing components. Component Editor is used to manage components – draw schematic symbol and connect them with pattern drawings (footprints). However, pattern drawing is not editable in the Component Editor, Pattern Editor should be used instead.*

*Read **Working with libraries** topic in the Component and Pattern Editor Help documents for more details.*

## 4.1 Designing a pattern library

Open DipTrace Pattern Editor, i.e. go to "Start \ All Programs \ DipTrace \ Pattern Editor" on Windows machine or use DipTrace Launcher on MacOS.

If you create a new component it is always better to start with drawing a PCB footprint (pattern), which you can assign to a certain schematic symbol in the Component Editor. If you know that the pattern is already available in the standard pattern libraries, you can proceed directly to the Component Editor to draw the schematic symbol, attach that existing pattern, and save complete component in the component library (\*.eli file). However, we will start from the footprint design just to teach you how to do it and give you a full perspective of the design process.

### 4.1.1 Customizing Pattern Editor

First of all, we need to show a center point and X, Y-axes, select "View \ Display Origin" from the main menu or press *F1* hotkey (if it is not displayed yet). Notice that you can change the origin at any time while designing a pattern ("View \ Define Origin \ ..." from the main menu or press  button on the Instruments toolbar). Origin is a zero point of the pattern when you place, rotate, or change pattern's position by coordinates in the **PCB Layout**.

Pattern Properties panel in the upper-left of the design area allows the engineer to design patterns by types or templates, define pattern attributes, attach 3D model, and change default pad settings. The panel can be hidden, minimized or moved during pattern design. To minimize the panel, click the arrow button in its upper-left corner. To hide/show this panel select "View \ Toolbars \ Pattern Properties" from the main menu.

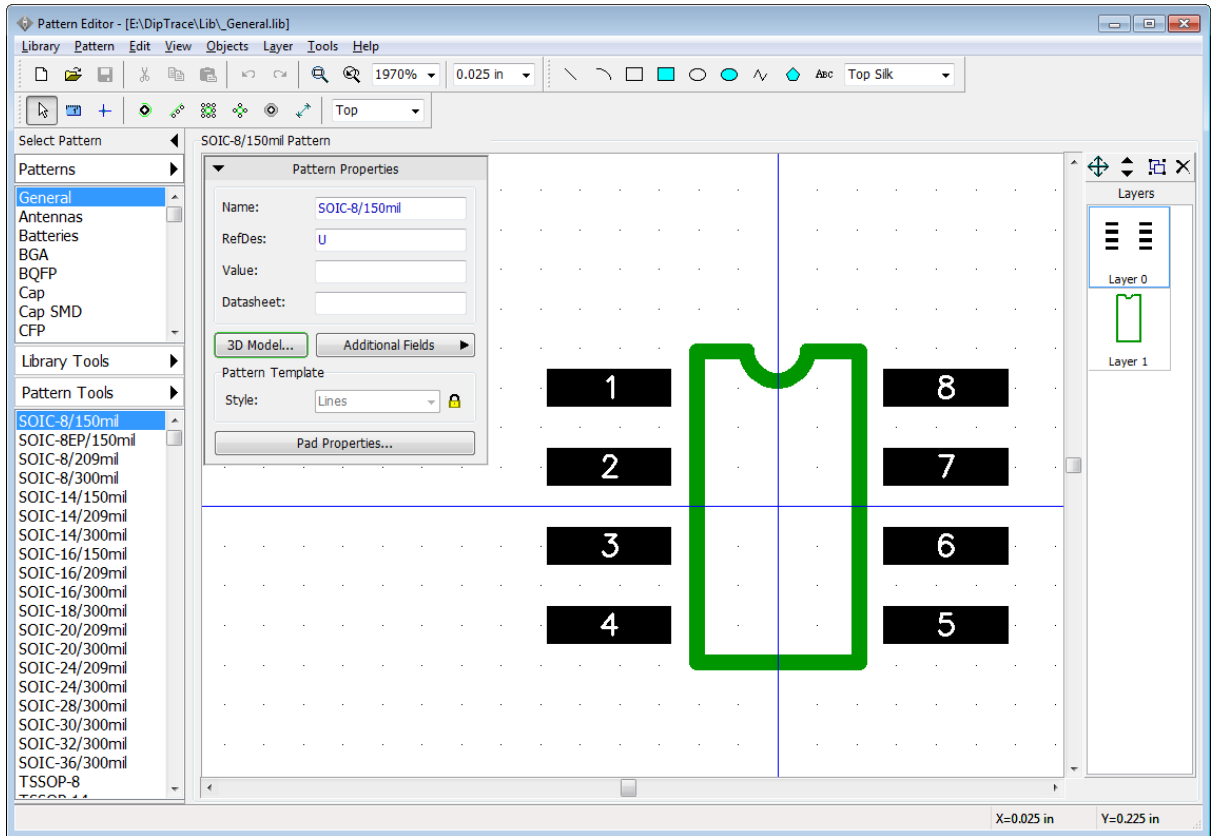

Use the *Plus Sign (+)* and *Minus Sign (-)* hotkeys or the mouse wheel for zooming in and out in the Component and Pattern Editors or change scale in the scale box on the Instruments toolbar. Go to "View \ Pad Numbers \..." to show/hide the pad numbers.

### 4.1.2 Create/Save library

#### Create a library

Press **Library Tools** \ New Library on the Library Manager panel on the left side of the screen. In the pop-up dialog box enter the library name, hint, and select the library group. You can't save a library outside any of the library groups. We recommend creating new libraries in the **User Patterns** library group offered by default. Press **OK**.

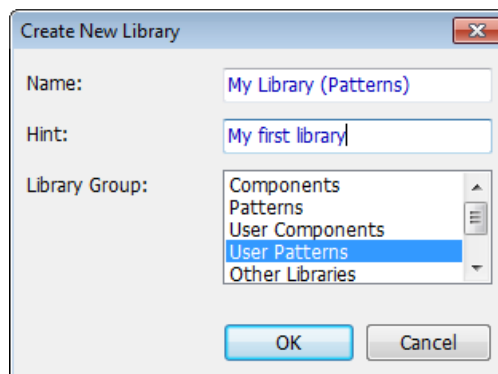

A name of your library will appear on the Library Manager panel, User Libraries library group becomes selected automatically. Now save the newly created library in a separate file.

## Save library

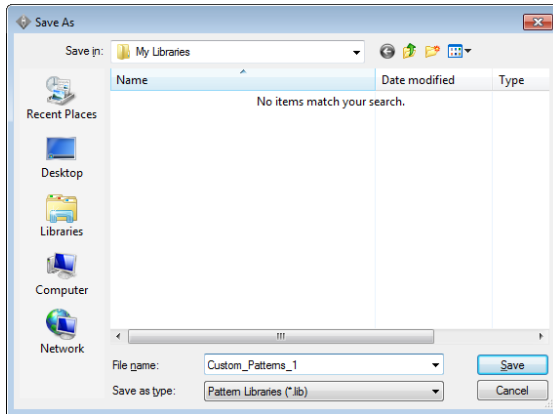

Once a library has been created you need to save it in the file. Select "Library \ Save" from the main menu. We recommend saving user libraries in the "Documents/DipTrace/My Libraries" folder for Windows, which is offered by default, however, you can select another location (Mac users should save custom libraries in another location because you can accidentally lose the "My Libraries" folder when uninstalling the software).

*DipTrace does not allow for saving user libraries in the folder with standard libraries.*

Type in the file name (not shown in DipTrace), and press **Save**.

Now we have "My Library (Patterns)" pattern library, which belongs to the User Patterns library group and is saved on your computer. Notice that file has \*.lib extension, saying that this is a pattern library.

### 4.1.3 Designing a resistor (pattern)

We will design the first pattern of our library, it is going to be a resistor with 400 mils lead spacing.

First, we need to name the pattern and fill up the basic description fields. Type "RES 400" into the Name field, "R" – into the RefDes field and "47k " – into the Value field on the **Pattern Properties** panel. In DipTrace Pattern and Component Editors, you need to define just a basic RefDes (not a number index). For example, when you place several resistors: R1, R2, R3, etc., the designators will be assigned automatically. Use Windows Special Characters Map to find and copy/paste special symbols for Ohms, Farads etc.

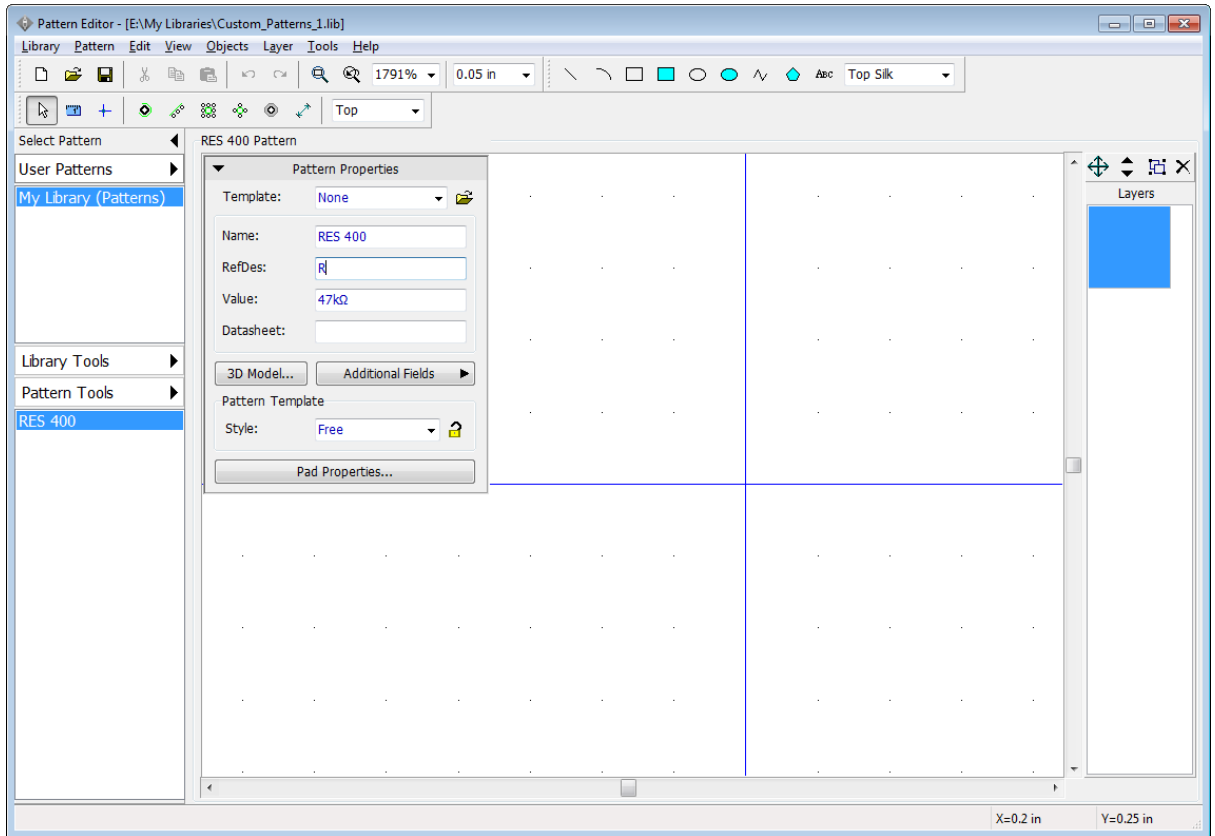

For this pattern, we have used the Free style, but it is faster to use Lines instead. You'll see how to do this in one of the subsequent topics.

### Placing pads

Please make sure that 0.05-inch grid is selected (change measurement units in the "View \ Units" main menu item or with *Shift+U* hotkeys) then minimize the Pattern Properties panel.

Select the **Place Pad** tool (  button on the Objects toolbar) and left-click on the design area to place two pads like in the picture below. Right-click to exit the placement mode.

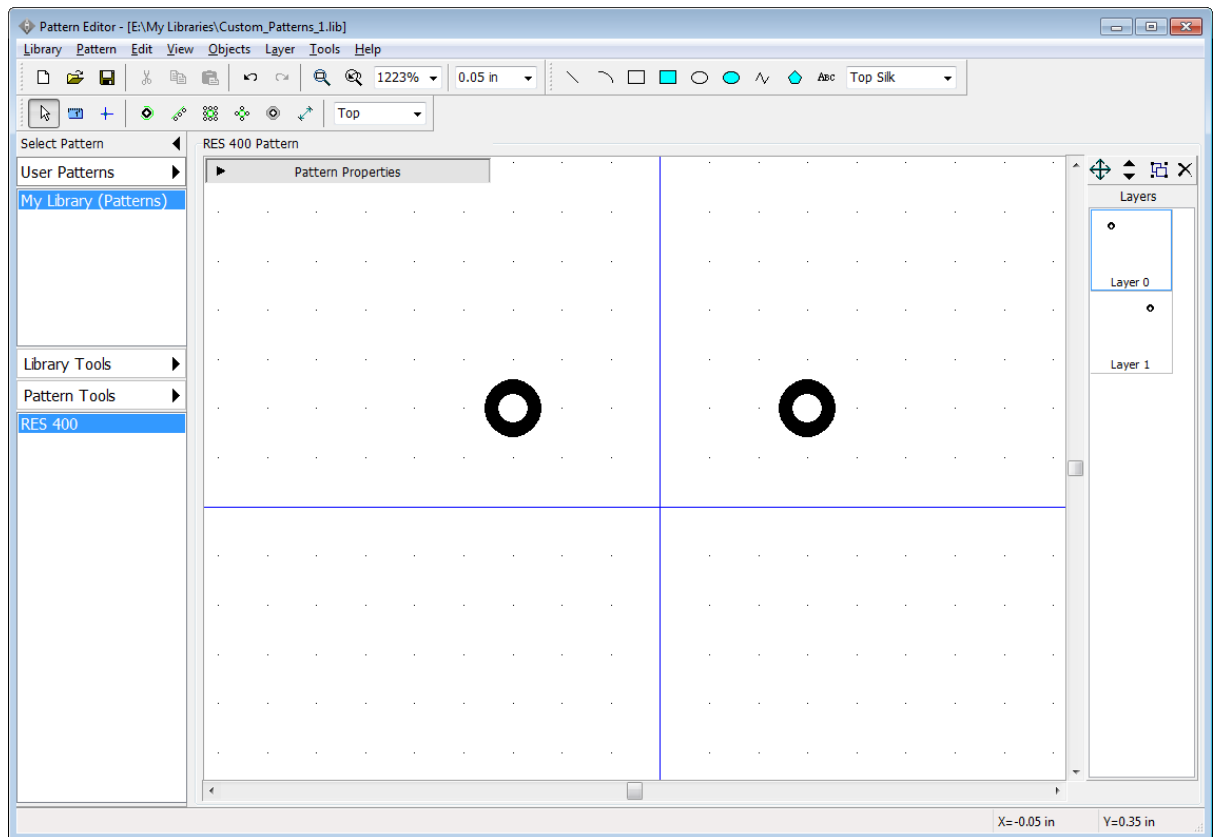

Such placement is not an accurate method, it requires manual correction of pad coordinates. Let's place a dimension line, this will make editing more simple and visual. Select "Objects \ Place Dimension \ Horizontal" from the main menu or Place Dimension \ Horizontal tool on the Objects toolbar, left-click in the center of the first pad, then in the center of the second pad, move the mouse pointer a bit upwards, and click one more time to place a dimension line. The key points of the object are highlighted when you hover over them with your mouse. Dimension pointer is attached to the key point, it recounts automatically when you move or resize objects.

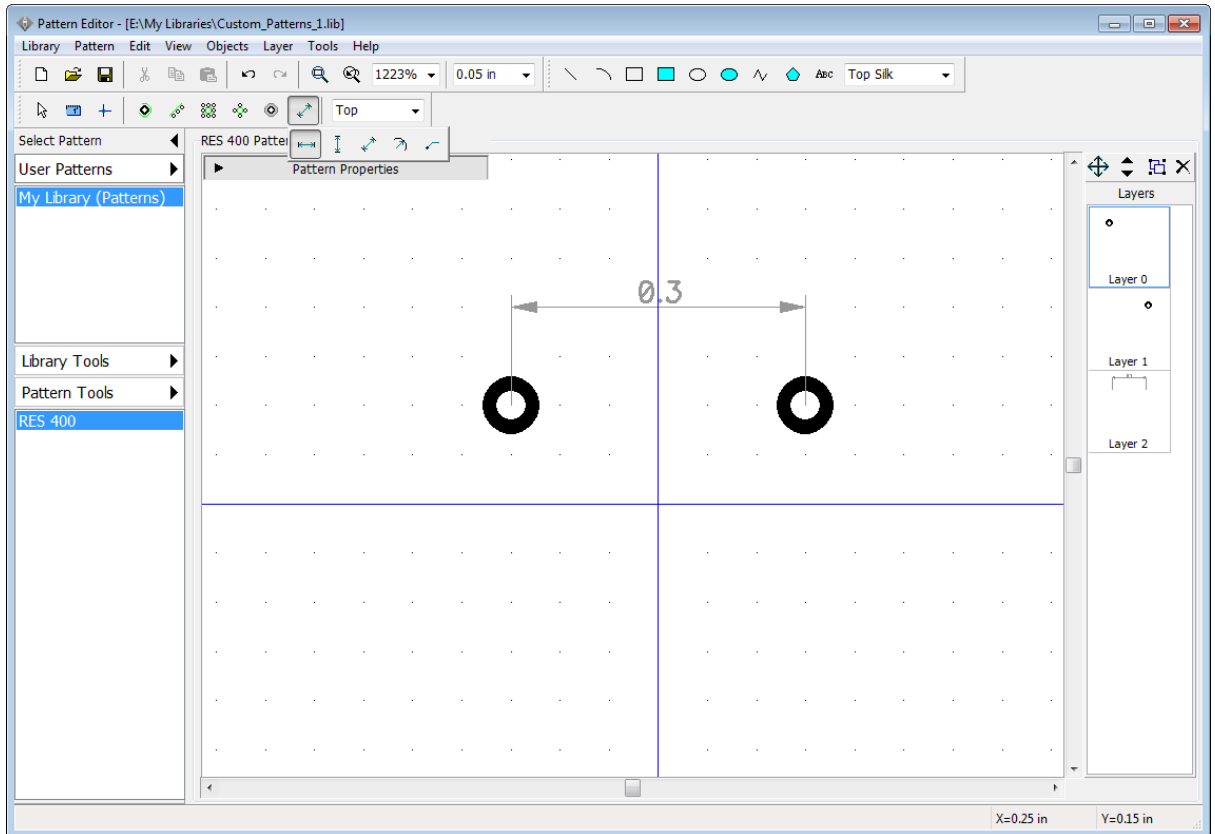

Right-click on the dimension line, and select **Properties** from the submenu to change Layer, Units, Arrow Size etc. Drag and drop the dimension line like a regular object if needed. If you want, you can use the **Align Objects** tool for automatically placing several objects in a row or column, just select two pads, and select **Align Objects** from the submenu to set up alignment direction and spacing.

### Layers

On the right side of the screen, there is a layer list. One layer per object on the design area.

*These are only the logical layers for convenient editing (not signal or silk layers that you used to work with in the PCB Layout).*

Select layers 0 and 1 (hover over the Layer 0, hold down the left mouse button, move the mouse cursor to Layer 1, and release the mouse button). Now merge this layers by selecting "Layer \ Merge Layers" from the main menu or press  button on the Layers panel. You have made a single layer with two pads in it; double click it to open the **Layer Objects** dialog box. Select pad/pads with incorrect coordinates and change X-axis coordinates to make 400 mils (0.4 inch) distance between the pads, then click **OK** to close the dialog box.

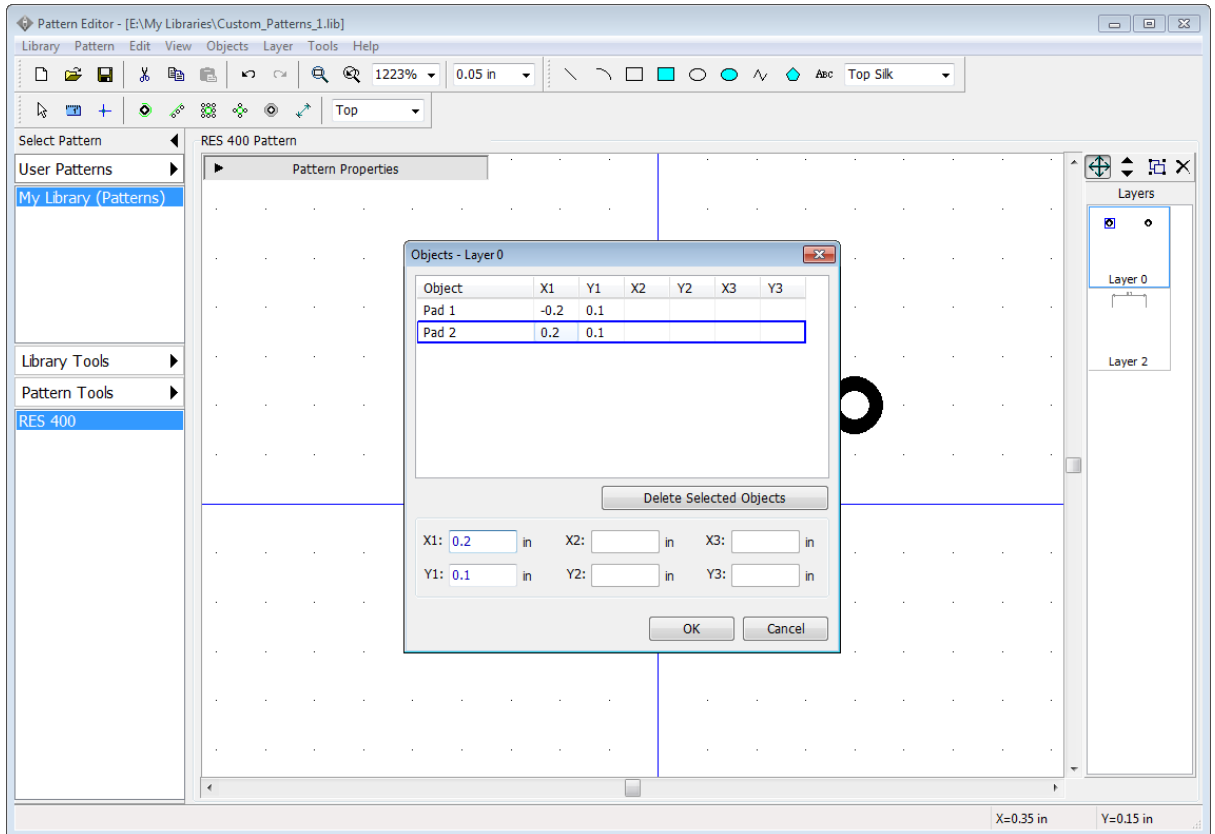

You can see that dimension line was recounted automatically and now displays correct distance value.

### Pad properties

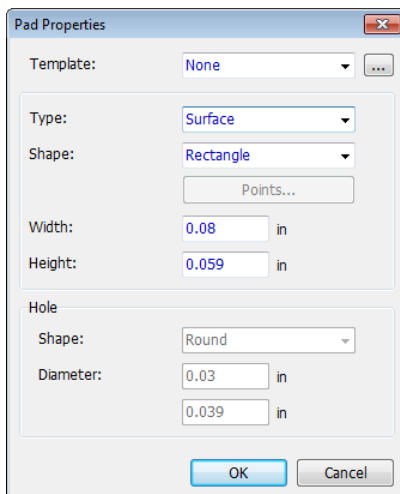

Pads can have default or custom properties. Default are applied to all pads of the pattern, custom – only to selected pad/s. To change default pad settings, select "Pattern \ Pad Properties" from the main menu or press **Pad Properties** button on the **Pattern Properties** panel. In the pop-up dialog box, you can change the pad shape: Ellipse, Oval, Rectangle or Polygon (click **Points** for polygonal pad customization). You can make round or oval holes and change the hole diameter (for **Through** pads only). Pad templates allow the user to quickly apply selected parameters in different dialog boxes of the Pattern Editor and PCB Layout.

Change pad shape to **Rectangle**, width to 0.08, height to 0.059, and **Type** to **Surface**, then click **OK** to apply changes. You can also change the measurement units (mil is 1/1000 inches).



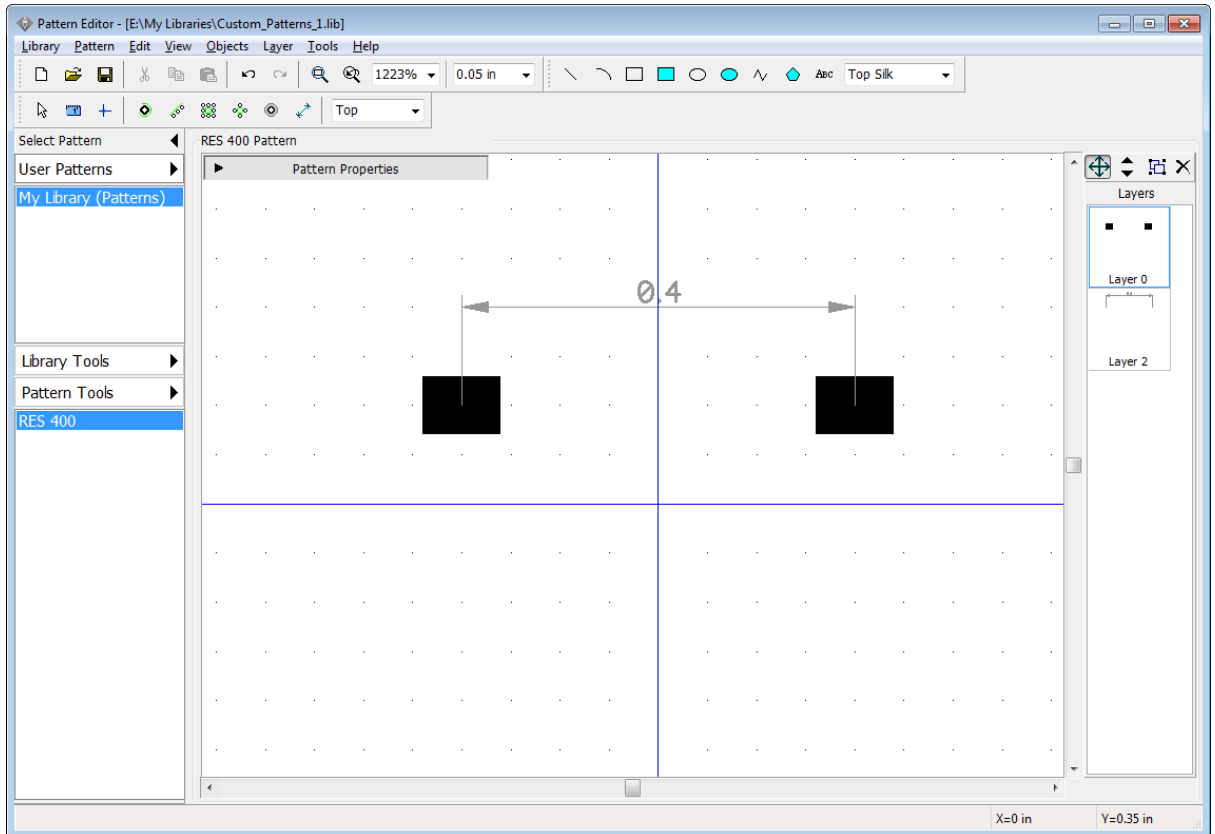

Notice that you can select the side for the surface pads, i.e. place them on the bottom side of the PCB. Select pad(s), right-click on one of them, and select **Change Side** from the submenu. Select current side for placing new pads and shapes on the Objects toolbar (drop-down box with the "Top" text).

We need the first pad to have custom pad properties. Right-click on the first pad, and select **Properties** from the submenu (if the pad is not highlighted while hovering over it, you're not in the default mode – right-click on any free spot or press  on the Objects toolbar). In the pop-up **Pad Properties** dialog box, select the **Type / Dimensions** tab, and uncheck **Use Pattern's Pad Properties** box to enable pad's custom settings.

### Polygon pads

Let's create a hexagonal-shaped pad. The fastest way to achieve that would be selecting an appropriate (Polygon1) template, but let's practice a bit. Do not assign any template, change type to **Through-Hole**, shape to **Polygon**, width and height to 0.09 inch and pad hole diameter to 0.04 inch, then press **Points** to open the **Polygon Points** dialog box. Here you can create regular or custom polygon shapes that are not available in the templates drop-down list.

Select: **Regular, 8 Sides**, and specify 0.045-inch **Radius**. Edit custom shapes with the table below or visually in the preview field (drag and drop the polygon's points).

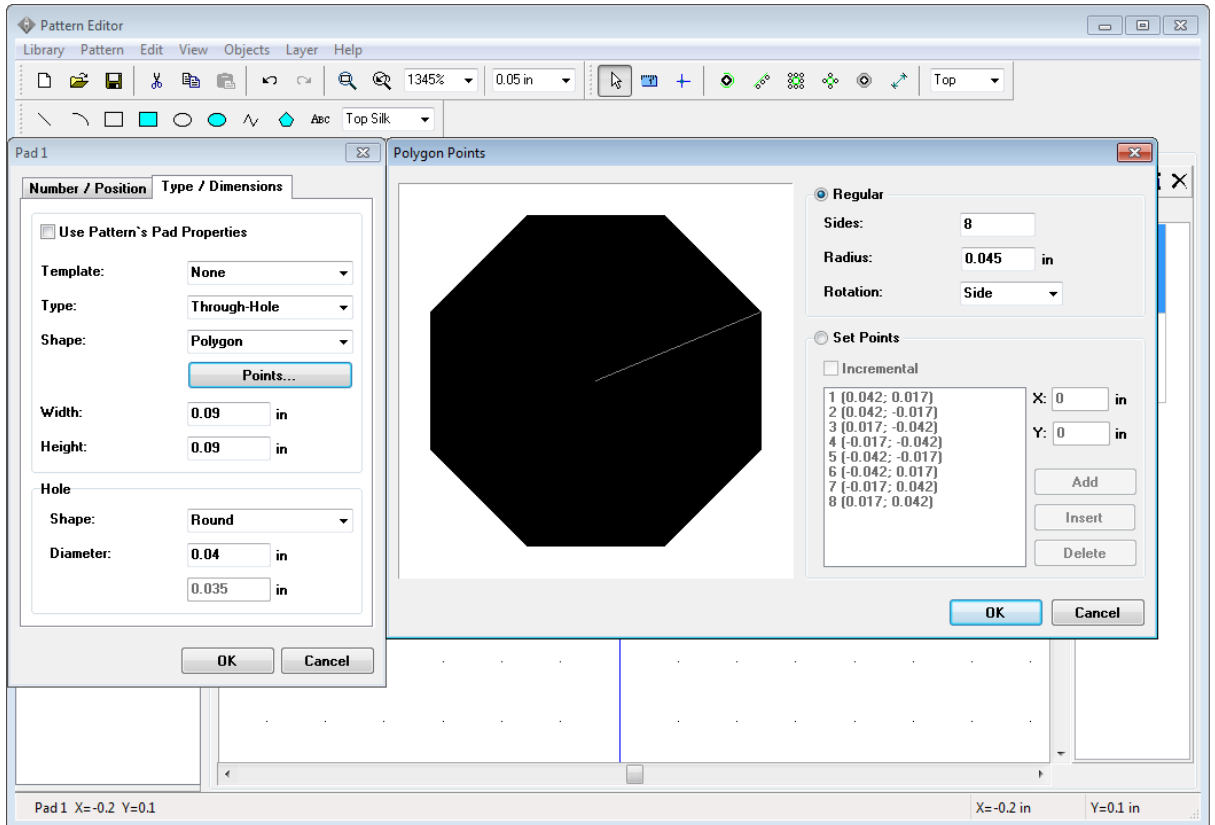

Press **OK** to apply the polygon shape.

You can change pad coordinates and direction in the **Number / Position** tab of the **Pad Properties** dialog box, but do not do this. Press **OK**. Changes will apply to all selected pads.

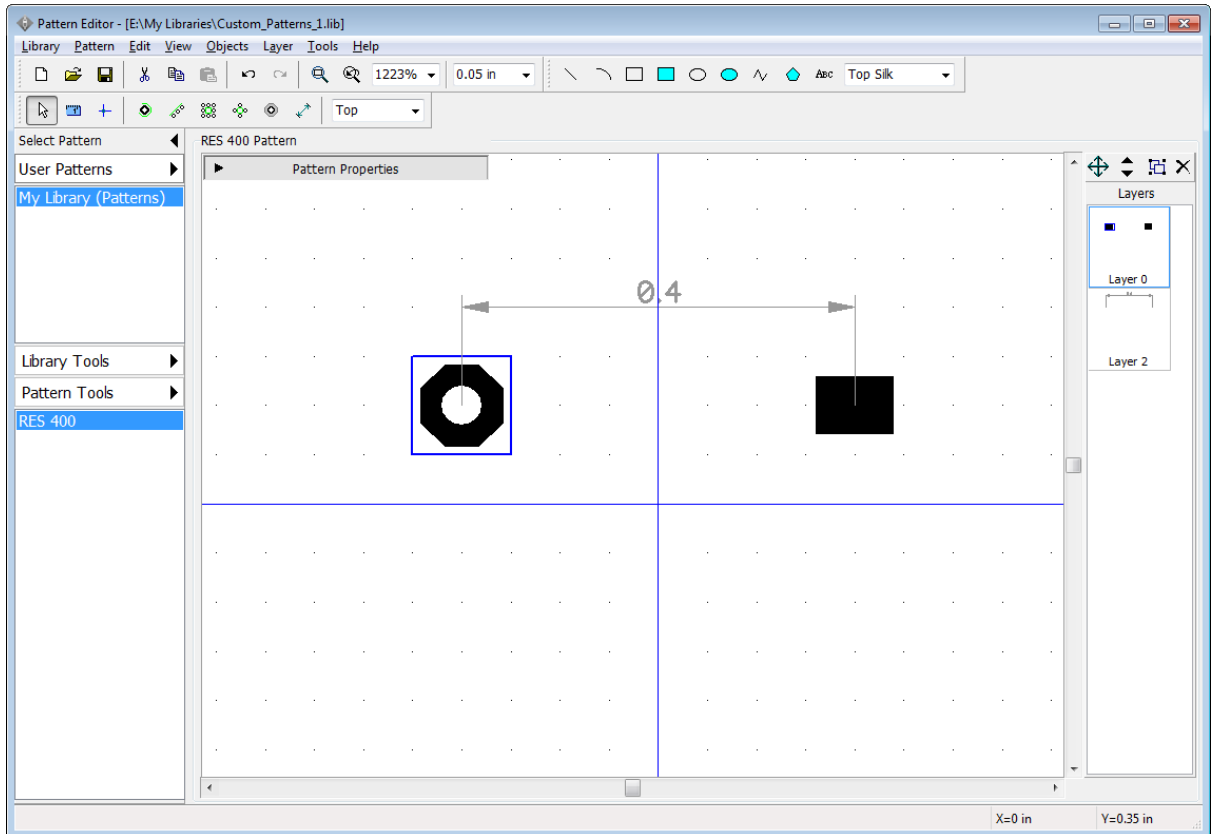

There is also another way to create polygon pads, select the Polygon tool on the Drawing toolbar and draw a shape directly on the design area. Make sure that shape is on the signal layer (select **Signal** from the drop-down list on the Drawing toolbar prior to drawing or change shape layer in the shape properties dialog box – right-click directly on the shape on the design area). When the shape on a signal layer is ready, right-click it, and select **Convert to pad** from the submenu. This options is visible only for Polygon drawing tool.

Please define the following properties for the pads:

first pad – 0.09x0.09, Through-Hole, Rectangle, hole diameter – 0.04;

second pad – 0.09x0.09, Through-Hole, Ellipse, hole diameter – 0.04.

Now let's place a silkscreen for this resistor. Select **Rectangle** button on the Drawing panel, make sure **Top Silk** layer is selected. Place a rectangle by clicking on two key points on the design area.

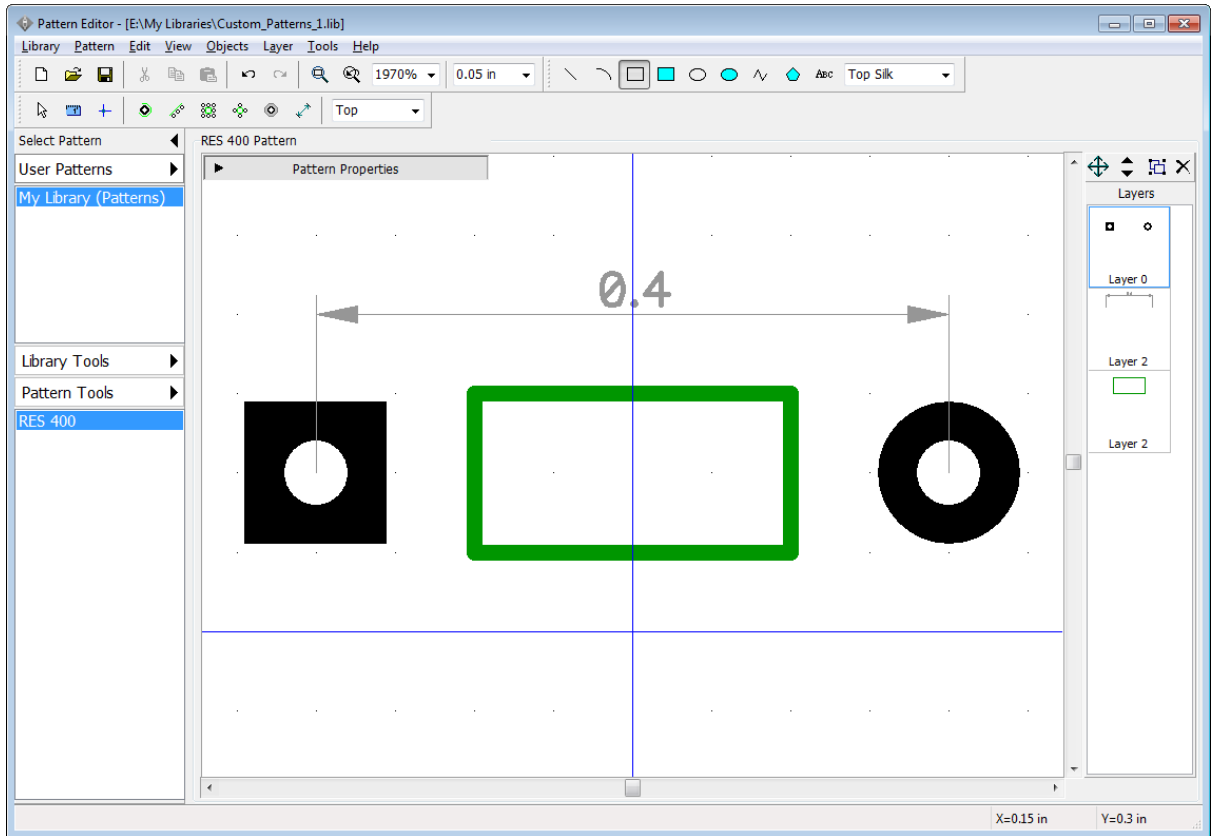

Now disable the rectangle placement mode (right-click on the free spot or press  button).

Silk shape looks a bit small for this pattern. There are several ways to change it: 1) Select "Layer \ Objects" from the main menu and enter new coordinates; 2) right-click on the shape, select **Properties**, and change points in the pop-up dialog box; 3) drag-and-drop shape's key points. We will use the last method, but first we need to change the grid size to 0.025 inch with *Ctrl+Minus Sign* hotkeys or with the grid box on the Instruments toolbar, then hover over rectangle's key points, and resize the shape (the mouse cursor shows possible directions).

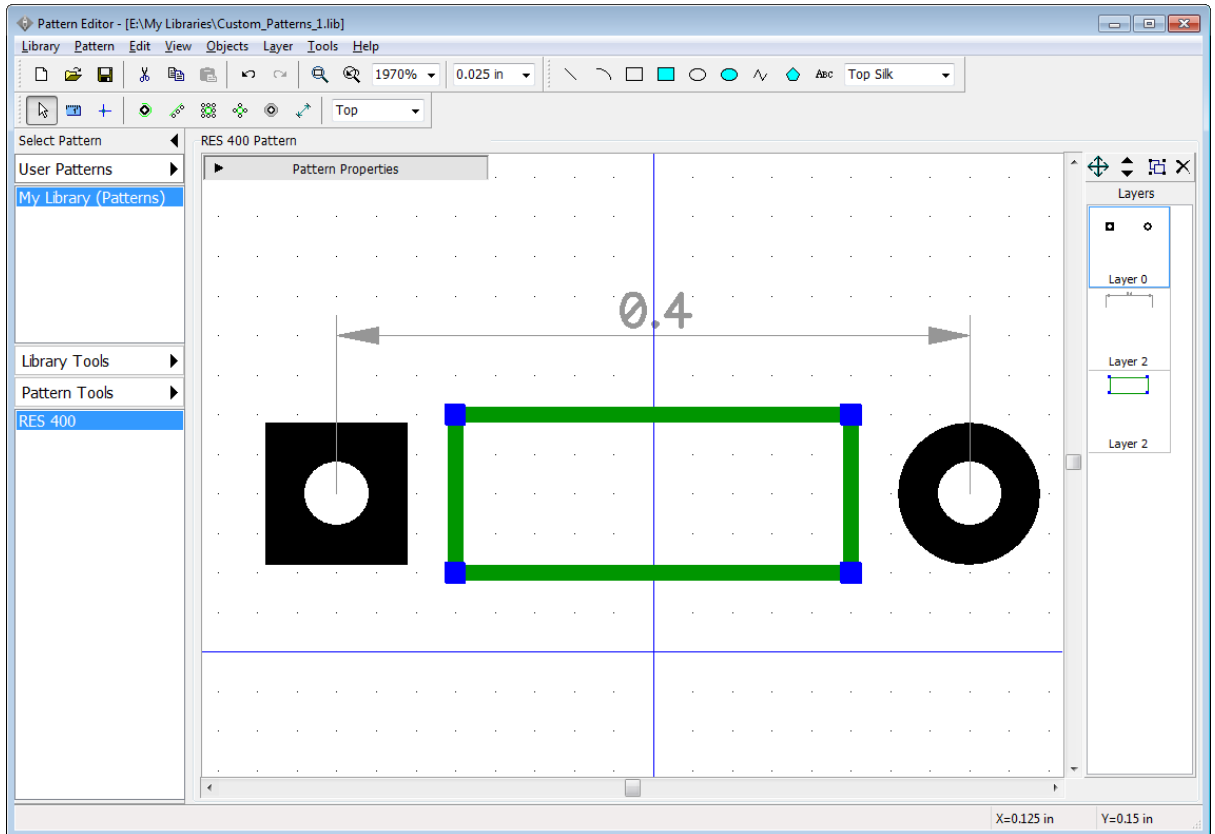

Center the pattern by selecting "Edit \ Center Pattern" from the main menu or *Ctrl+Alt+C*. The resistor is ready.

Try to rotate and mirror the first pattern of your library, select "Edit \ Rotate Pattern" to rotate and "Edit \ Vertical Flip", "Edit \ Horizontal Flip" to mirror it. Press **Save** on the Standard toolbar. We will attach 3D model for this resistor in the next topic of this tutorial.

#### 4.1.4 Attaching a 3D model

Please make sure that you have downloaded and installed **free 3D Models package** from the [DipTrace official website](#), which contains more than 7,500 3D models for various components.

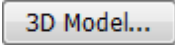
When component footprint (pattern) is ready we can attach a 3D Model. Press  button on the **Pattern Properties** panel. In the pop-up dialog box press **All Models** button and the list of all available 3D models will pop up, 3D models are sorted by libraries. We will probably find an appropriate resistor model in the **\_General** library. Scroll it down to find the **res-10.16\_5.1x2.5.step** model, left-click it, and it will appear on the footprint. Sometimes you might need to map a 3D model respectively to the footprint (like in the picture below).

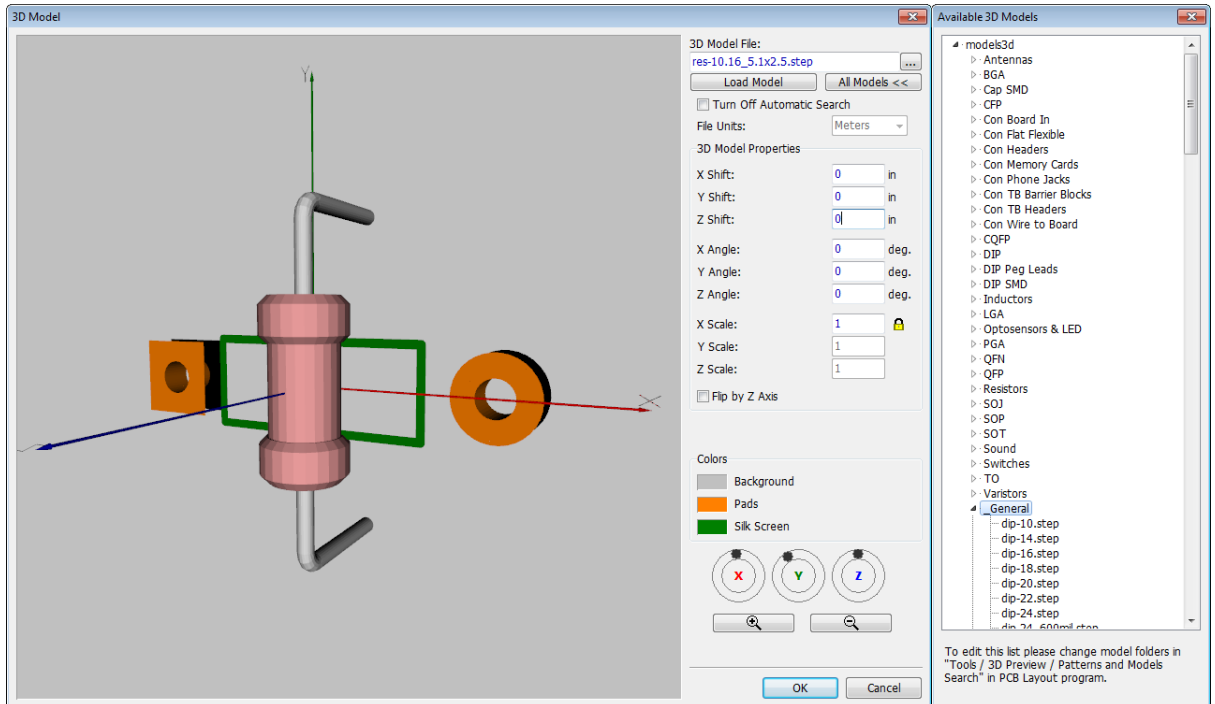

### Mapping a 3D model

DipTrace automatically places a 3D model to fit the pattern's drawing, however, sometimes you may need to adjust 3D model location or the scale. Just enter appropriate values into the corresponding fields on the **3D Model Properties** section (shift, angle, and scale for each axis). In our case, we see that we need to rotate the resistor 90 degrees and shift it up a bit. Specify 90-degree **Z Angle** and 0.03 inch **Z Shift**. You can rotate a 3D model by three axes, zoom in / out, and pan 3D Model preview with the mouse (left, right and wheel clicks) or using the wheels at the bottom of the dialog box.

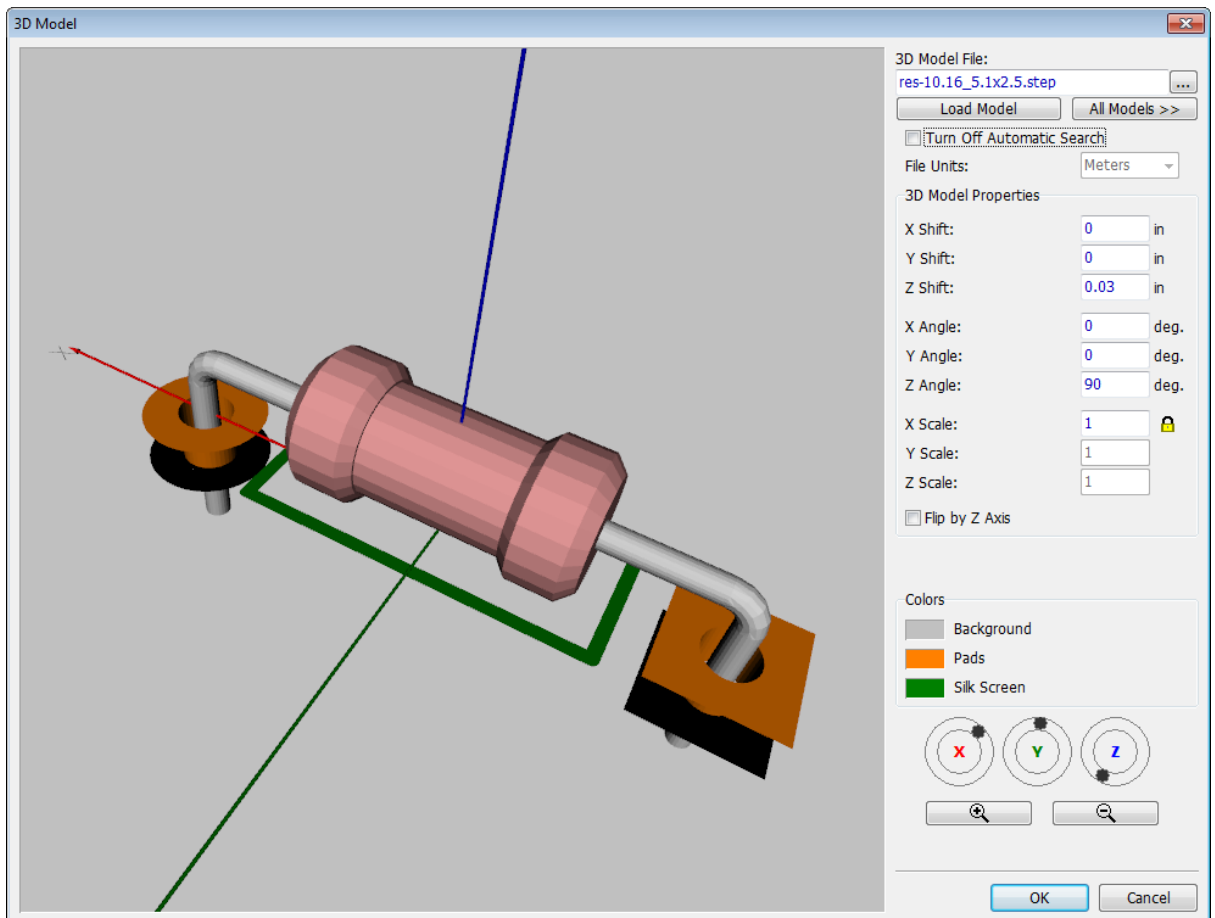

Press **OK** to attach a 3D model, and then save the pattern library. More details about [DipTrace 3D Module](#)<sup>[236]</sup> later in this tutorial and in the DipTrace Help ("Help \ Pattern Editor Help" from the main menu).

#### 4.1.5 Designing BGA-144/13x13

Press **Pattern Tools**, then select **Add New Pattern to My Library (Patterns) Library** on the Library Manager panel. This will add an empty pattern to the library. The pattern is selected. We will create BGA-144/13x13 (x0.8\_10x10) pattern using available pattern types and automatic pad numeration. Maximize the Pattern Properties panel and type in the pattern's name.

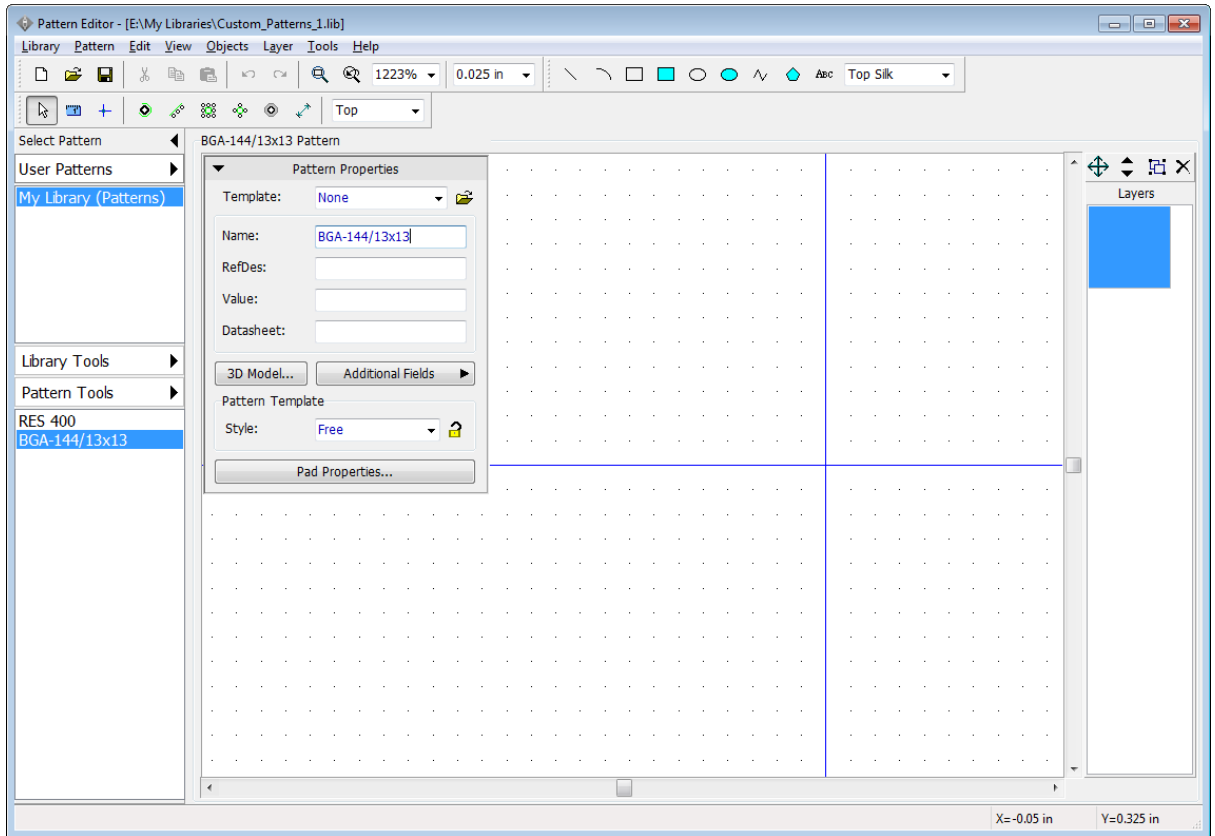

Change units to **mm**, press **Shift+U** hotkeys, then go to "Pattern \ Pad Properties" from the main menu and set: **Type: Surface, Shape: Ellipse, Width: 0.45 mm, Height: 0.45 mm**. Press **OK** to apply changes to default pad properties. On the Pattern Properties panel set: **Style: Matrix, Columns: 13, Rows: 13, X Pad Spacing: 0.8 mm, Y Pad Spacing: 0.8 mm**. 13x13 pad matrix and pad spacing dimensions appear on the design area.



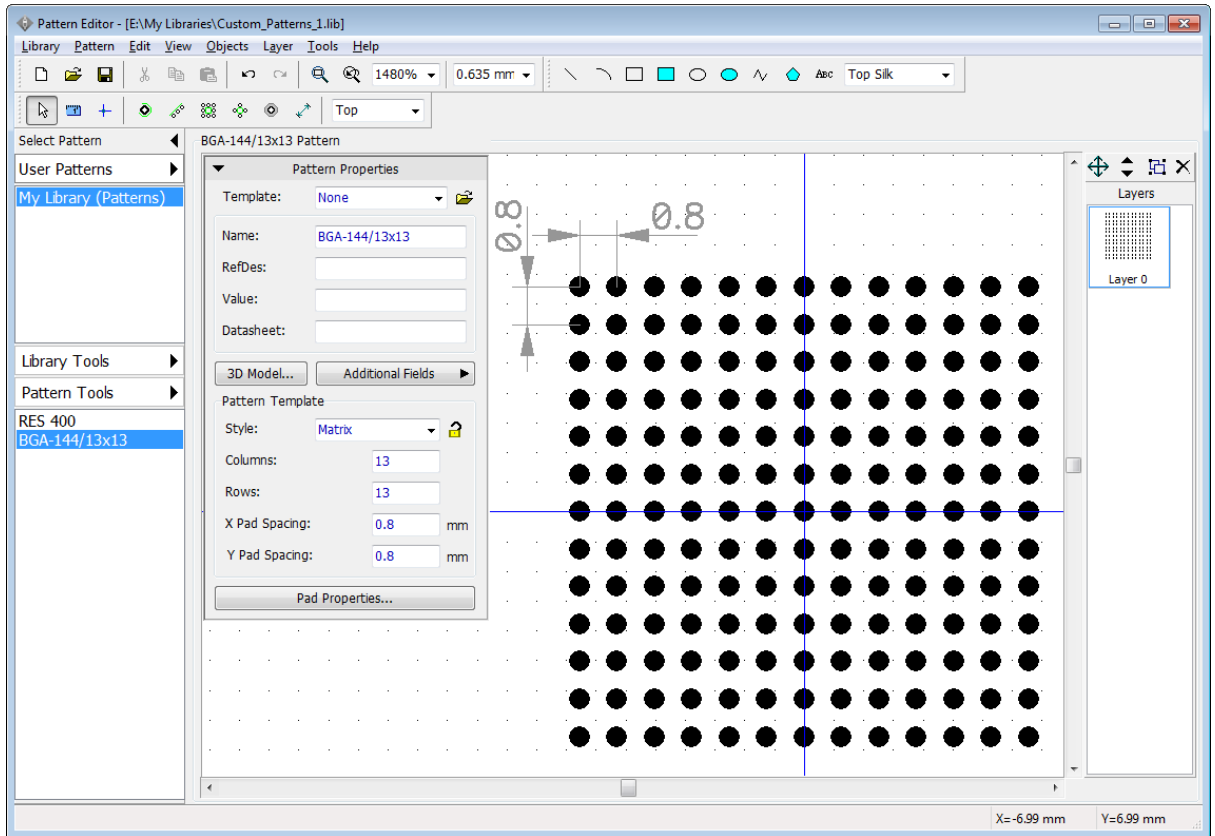

Click  button on the **Pattern Properties** panel to prevent accidental changes. Minimize the **Pattern Properties** panel. Pan design area if necessary with the right mouse button or zoom with the mouse wheel. For the BGA-144/13x13 pattern, we should delete 5x5 rectangle of pads in the center, like in the picture below. Select these pads using the box selection (move mouse to the upper-left corner, hold down the left mouse button, move to the bottom-right and release the button), then press *Delete* key on the keyboard to delete selected pads.

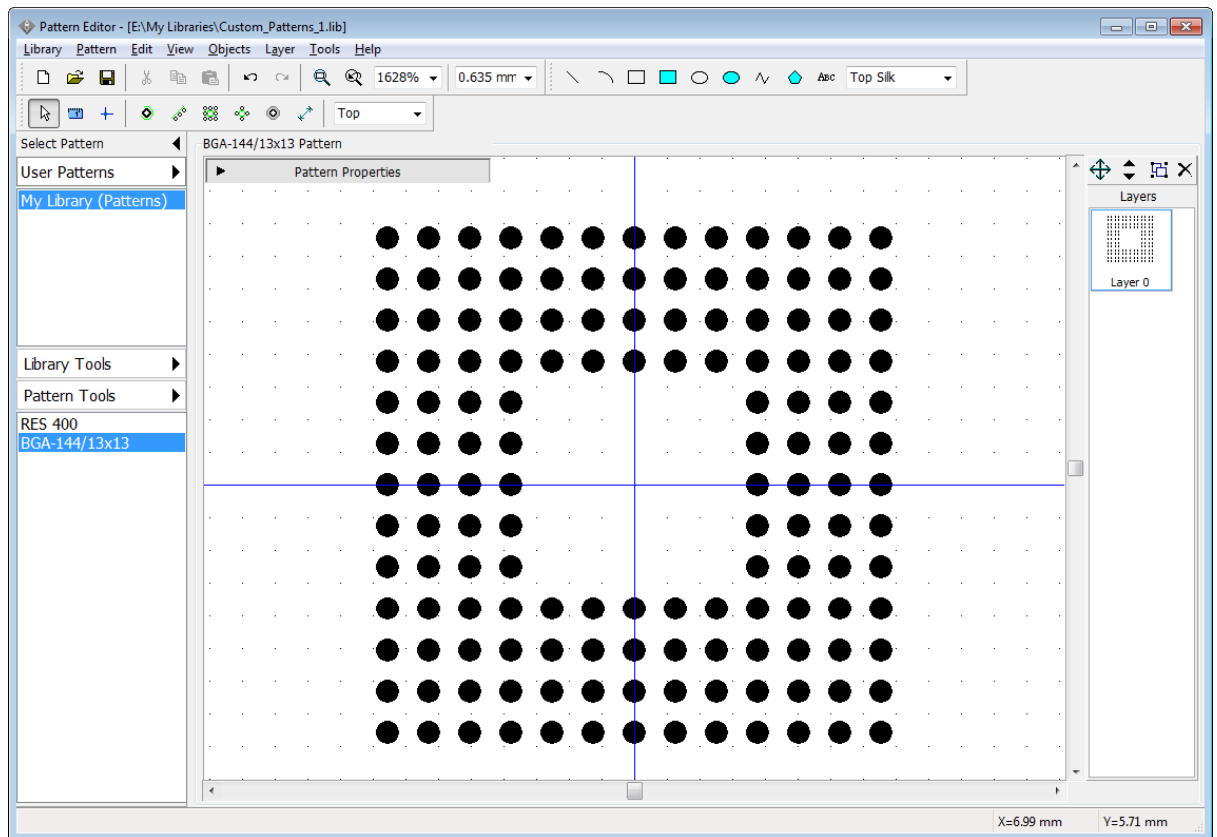

Select "View \ Pad Numbers \ Show" from the main menu to display pad numbers. Notice that our matrix has 1 – 169 numbers with some missing numbers in the center. This is not right. BGA pads should be A1, A2, A3 etc. Select all pads (*Ctrl+A* or a box selection), right-click on one of the pads, and choose **Pad Array Numbers** from the submenu. In the pop-up dialog box, select **Type: BGA Matrix**, keep other settings, and press **OK** button.

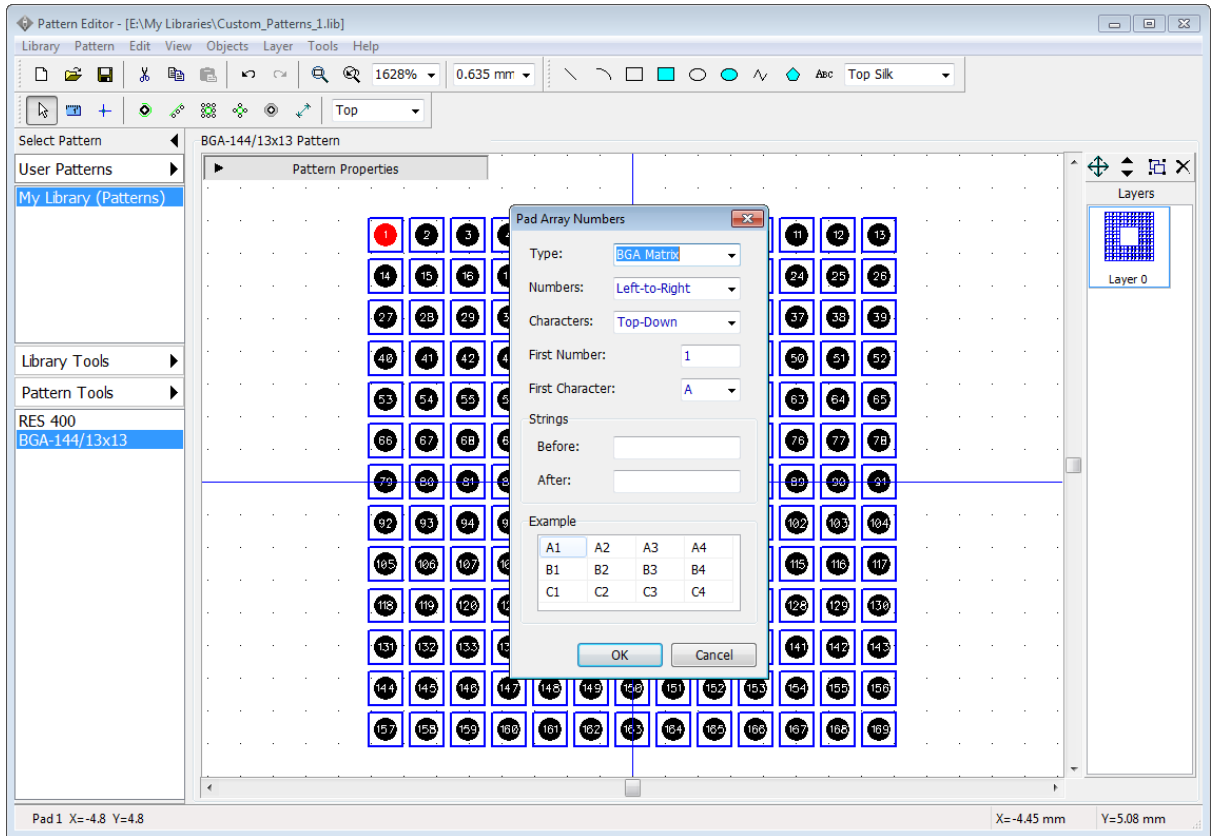

Now pad numeration is correct.

Notice that for **Contour** type of numeration the first pad will be the one you right-clicked on. This allows the user to numerate contour pads (QUAD patterns) starting from the upper-left, center or any other pad of the pattern.

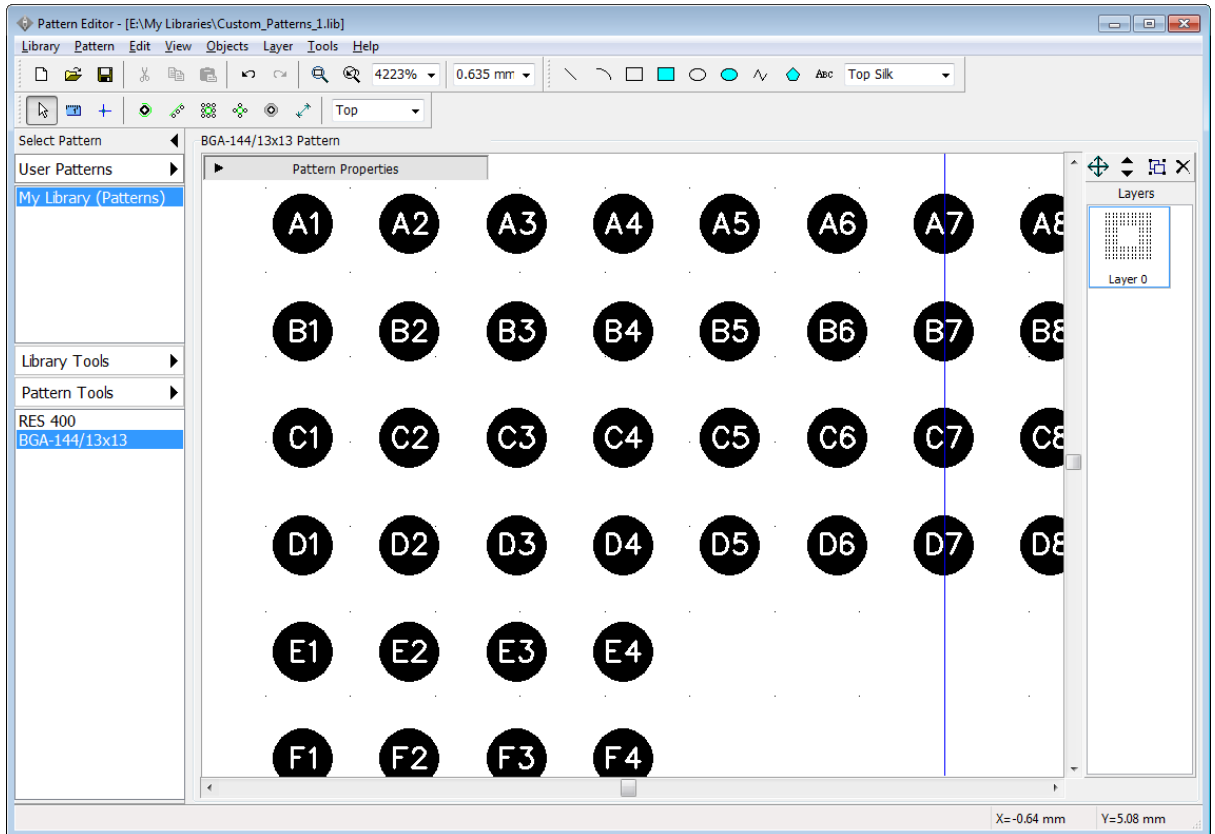

Now draw a silkscreen for the pattern (like in the picture below), using the tools on the Drawing toolbar. Change grid size with *Ctrl+Plus Sign*, *Ctrl+Minus Sign* or turn it OFF/ON with *F11* hotkey. You can move objects with drag and drop or with the **Move Layer** feature (select layer in the list on the right side and drag-and-drop all objects of this layer directly on the design area with respect to each other).

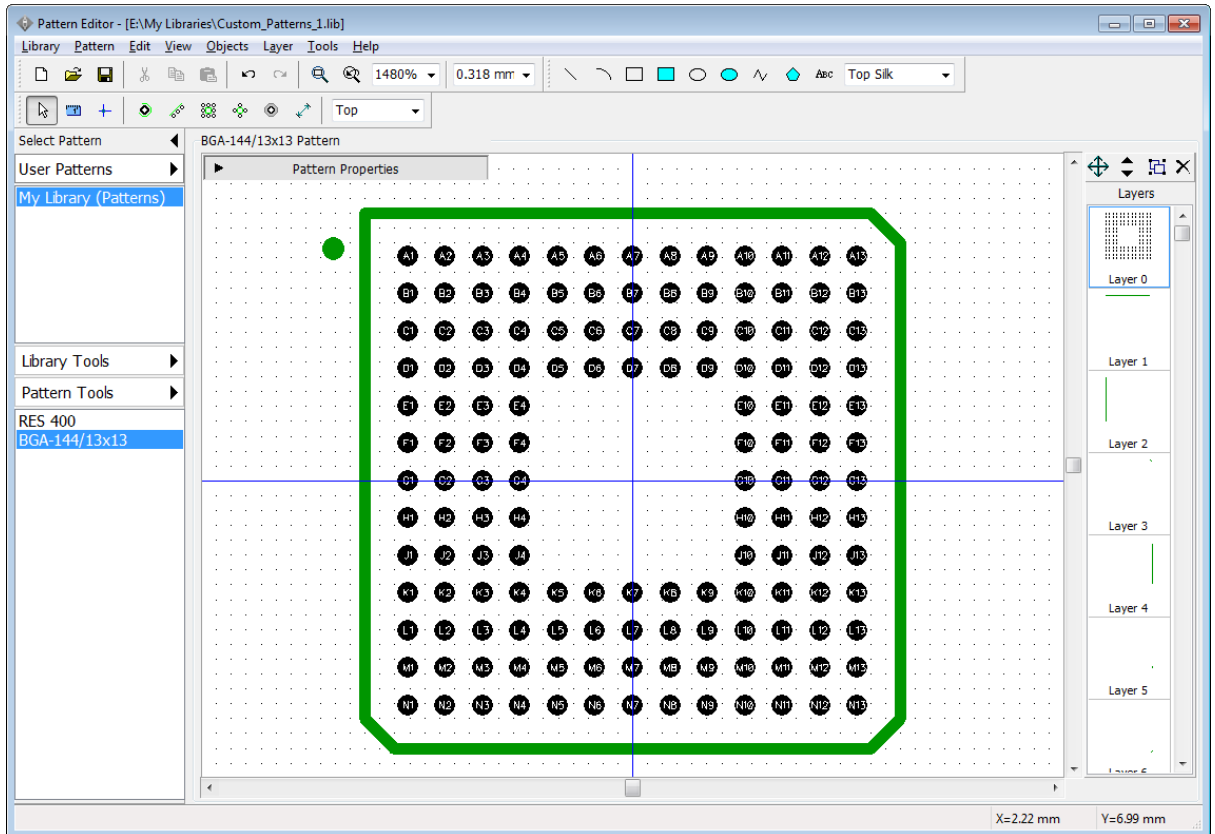

BGA pattern is ready. You can attach a 3D model now. Unfortunately, there is no BGA-144/13x13x0.8\_10x10 3D model in the standard 3D model libraries, but we don't need that precision for the 3D model. DipTrace allows the user to attach any 3D models in \*.3ds, \*.wrl, \*.step, and \*.iges formats to any footprint. You can download models from the component manufacturers' websites or create them in any 3D CAD.

### 3D model properties

Press  button on the **Pattern Properties** panel.

If you have an appropriate model on your computer click  button, select 3D model file on your computer, and press **Open**. You can also enter 3D model's disk address, and press **Load Model** button – a 3D model will appear on the preview area. Change 3D Model Properties in case the model does not correspond to the footprint.

For example, we have decided to take the bga-144\_12x12x1.27\_17x17.step 3D model from the BGA library in the standard 3D model package and scale it down a bit to fit the footprint (see the picture below).

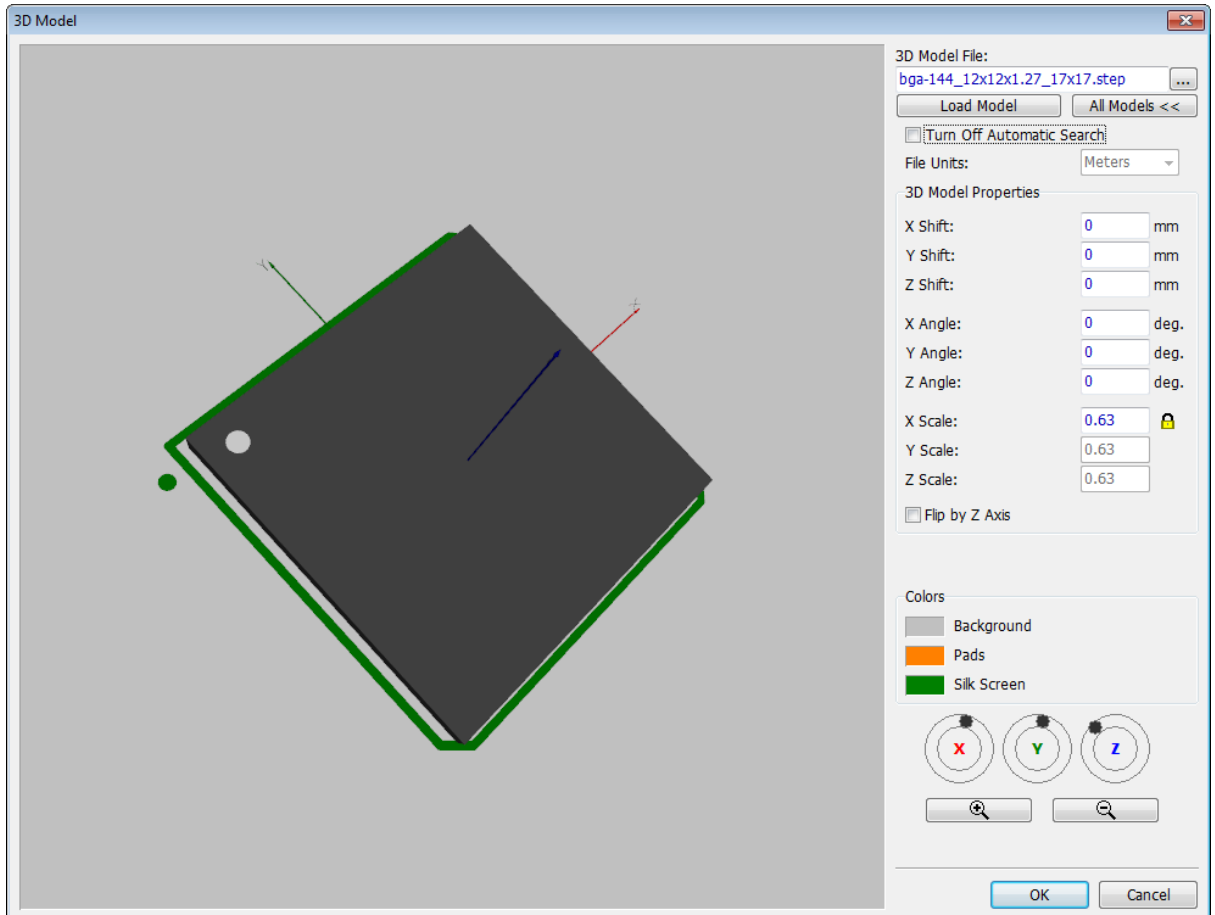

Try to enter different values into various fields and you will understand how to fix model's location. Press **OK**. Notice that **3D Model...** button glows green when the pattern has attached 3D model and glows red when it does not.

Save the pattern library (*Ctrl+S* or **Save** button on the standard toolbar).

#### 4.1.6 Real component design. SOIC-28 pattern

When you are familiar with the basics, we can try to create a real component according to the datasheet. It's gonna be the simple Microchip PIC18F24K20 component with SOIC-28 pattern.

*When you start creating a component from a scratch, and you don't have an appropriate pattern, always start from the pattern creation and then proceed to component's symbol.*

We start from making a pattern. Add new pattern to the library ("Pattern \ Add New Pattern To "My Library (Patterns)" Library" from the main menu), then enter the name – "SOIC-28" and RefDes – "IC".

Select **Style: Lines** on the **Pattern Properties** panel, and set **Number of Pads: 28**. In our case pads are way too small for this pattern.

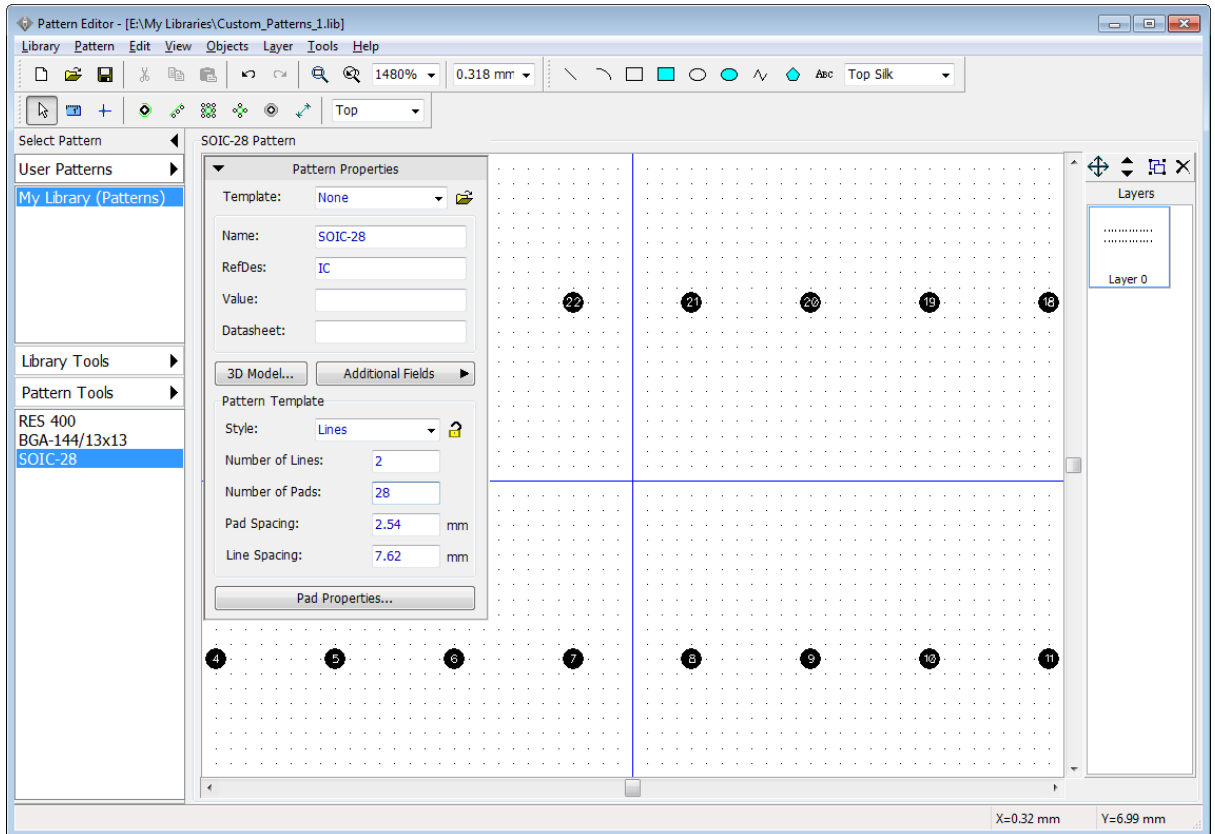

We should define correct pad spacing, line spacing, and pad settings. You can find SOIC-28 (7.50 mm) footprint dimensions on the [Microchip package specifications PDF](#) at the Microchip's website (page 197 in the latest revision at the moment of writing this tutorial) or you can take the SOIC-28 pattern from standard DipTrace libraries as an example.

Define default pad settings (press **Pad Properties** button to open the dialog box): **Type: Surface, Shape: Rectangle, Width: 0.6 mm, Height: 2 mm**. Press **OK**. Then specify **Line Spacing: 9.4 mm** and **Pad Spacing: 1.27 mm** on the **Pattern Properties** panel.

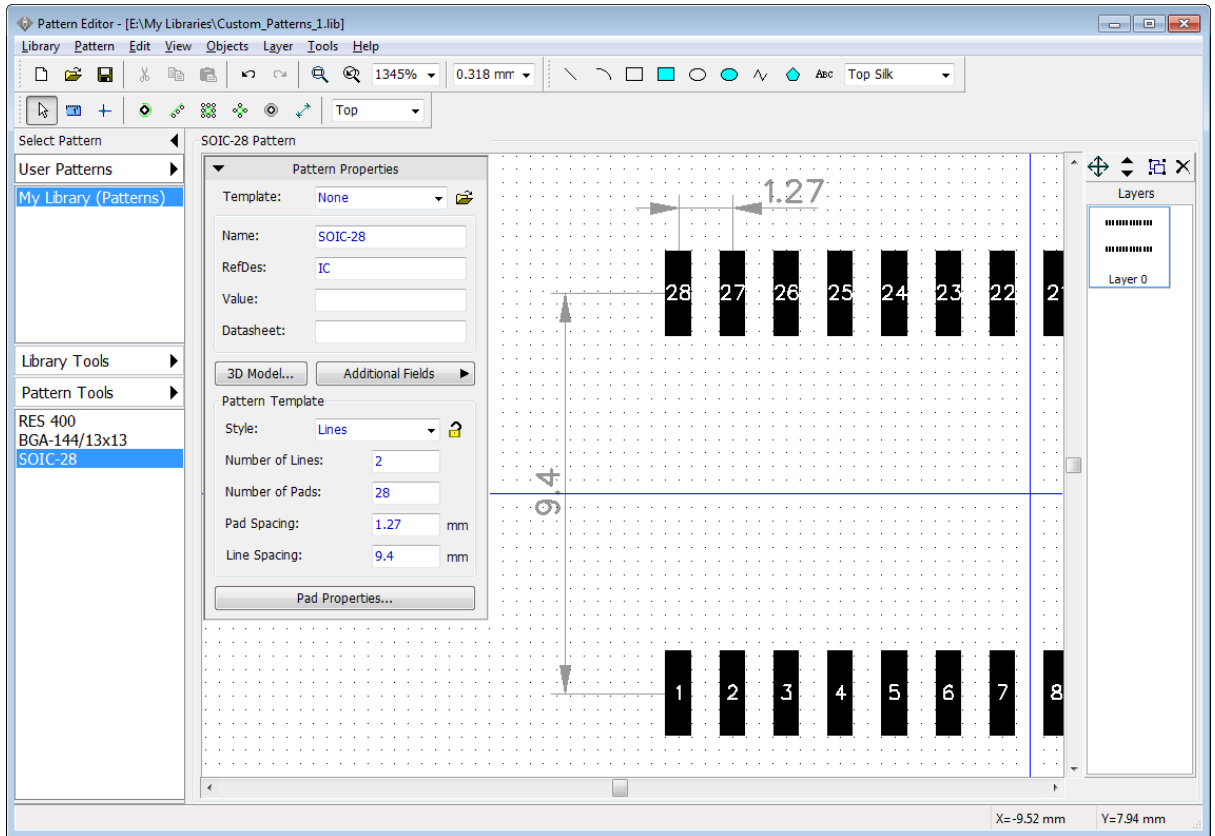

Pad numbers are correct, we don't need to renumber them. Lock pattern properties to avoid accidental changes. Draw a silkscreen (like in the picture below), using line/polyline and arc tools found on the Drawing toolbar (turn ON/OFF the grid, change grid size, and hide Pattern Properties panel if you need).



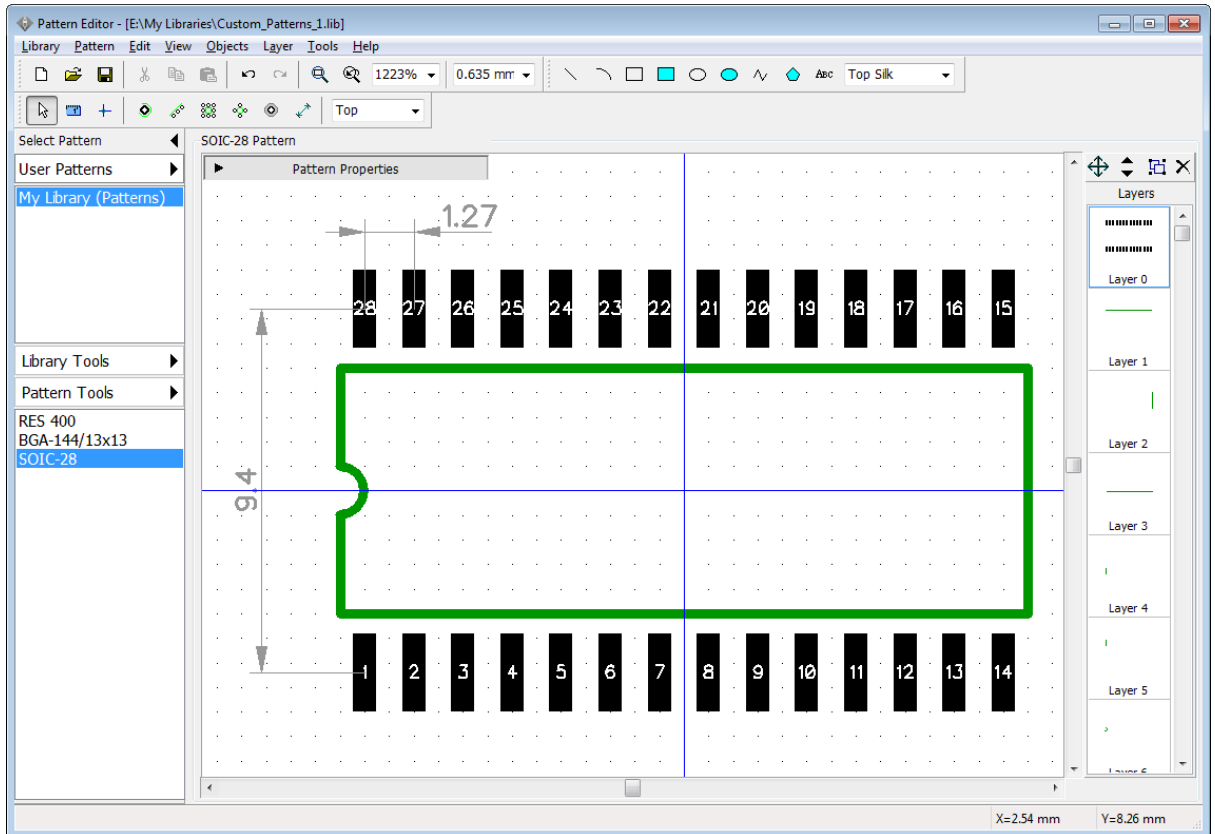

Datasheet requires the pattern to be rotated 90 degrees – select "Edit \ Rotate Pattern" from the main menu or *Ctrl+Alt+R*. **Attach** soic-28\_300mil.step 3D model from the **\_General 3D Models** category.

We will attach this pattern to PIC18F24K20 component, which we will create in the [Component Editor](#)<sup>[142]</sup> later in this tutorial.

Save this library and close the Pattern Editor.

## 4.2 Designing a component library

Open DipTrace Component Editor, i.e. go to "Start \ All Programs \ DipTrace \ Component Editor" in Windows or use DipTrace Launcher on MacOS.

Component Editor allows the user to create / edit and manage components and libraries in DipTrace. Component Editor allows attaching component's pattern to the symbol, but it doesn't allow pattern editing – use the [Pattern Editor](#)<sup>[94]</sup>.

### 4.2.1 Customizing Component Editor

Customizing the Component Editor is almost the same as customizing the Pattern Editor. Select "View \ Display Origin" from the main menu to show a zero point and X, Y axes (or press *F1*) if you can't see the origin point. Component Properties panel in the upper-left side of design area can be minimized or hidden using the buttons on the panel and in the main menu.

In the Component Properties panel, you can define the symbol style (4 styles available): Free (without any specific properties), 2 sides, IC-2 sides, IC-4 sides. The only difference between "2 sides" and "IC-2 sides" is a rectangle shape (IC Symbol) for the last one.

The fields that might look unfamiliar are the **Part Type** field and the **Part** field. The part type can be Normal, Power and GND or Net Port. A component can contain only one Power and GND part (if you prefer to hide all power nets of your schematic, then all power pins should be in this part). Net Port is a single-part component, we use net ports to connect wires logically. Net ports are usually applied to Ground or Power nets and schematics with flexible structure (we will design such component later).

The **Part** field indicates current part of a multi-part component.

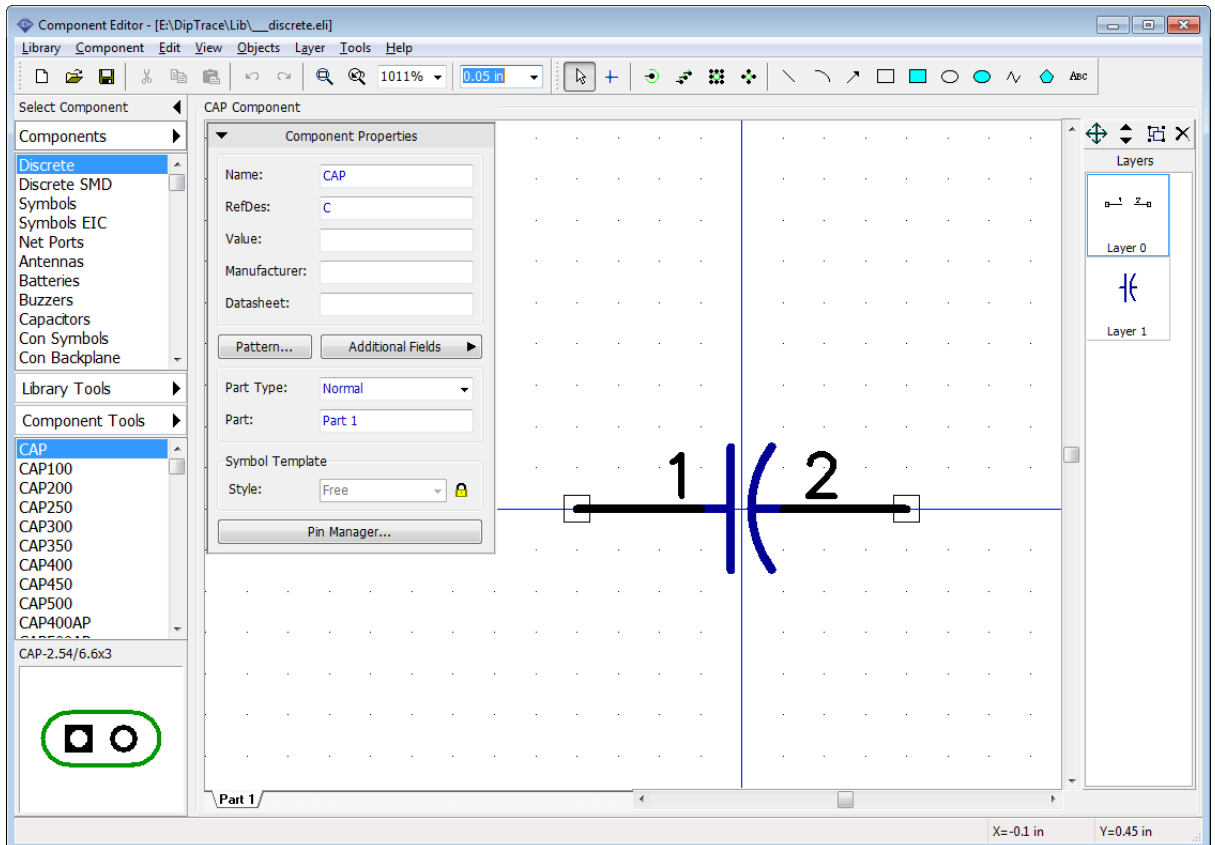

If you need to define pin settings before creating a component, select "Objects \ Pin Placement Setup" from the main menu. We will not change these parameters now, but notice that length and X, Y spacing should be **divisible** by the grid step to create all key points on the grid. We recommend using 0.1-inch grid.

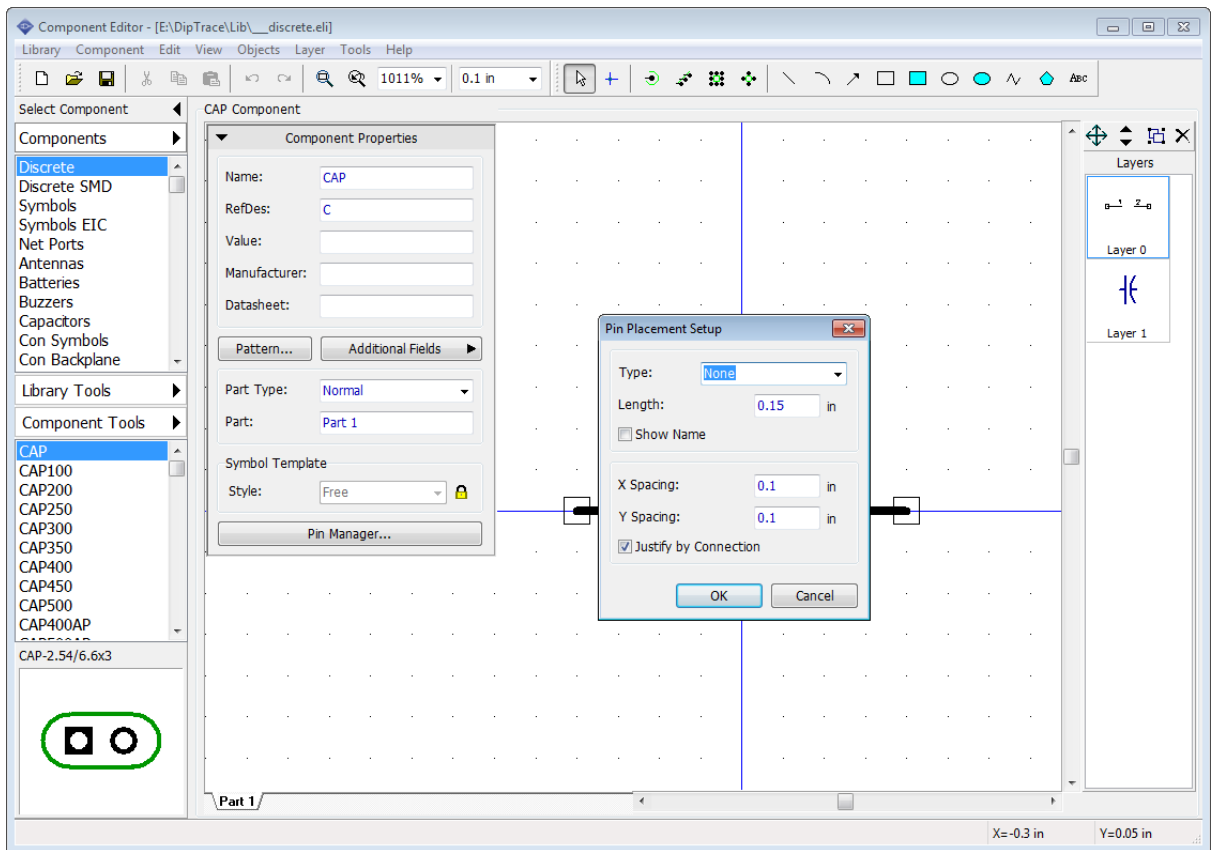

#### 4.2.2 Designing a resistor (component)

Like in the Pattern Editor, first, we need to create a new library because DipTrace won't let you add new components to standard libraries.

##### Create library

Press **Library Tools** , then select **New Library**, in the pop-up dialog box enter the library name, hint, and select the library group. We recommend saving this library in the User Components library group, offered by default. Press **OK**.

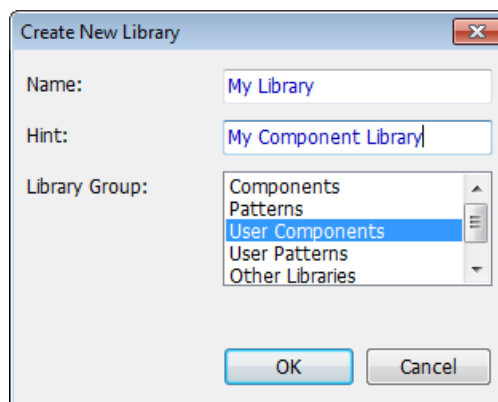

We will design the resistor using the Free style and visual pin placement. Define component name, RefDes, and value "47k ", use the corresponding fields on the **Component Properties** panel. After specifying these attributes, please minimize the panel, using the arrow in its upper-left corner.

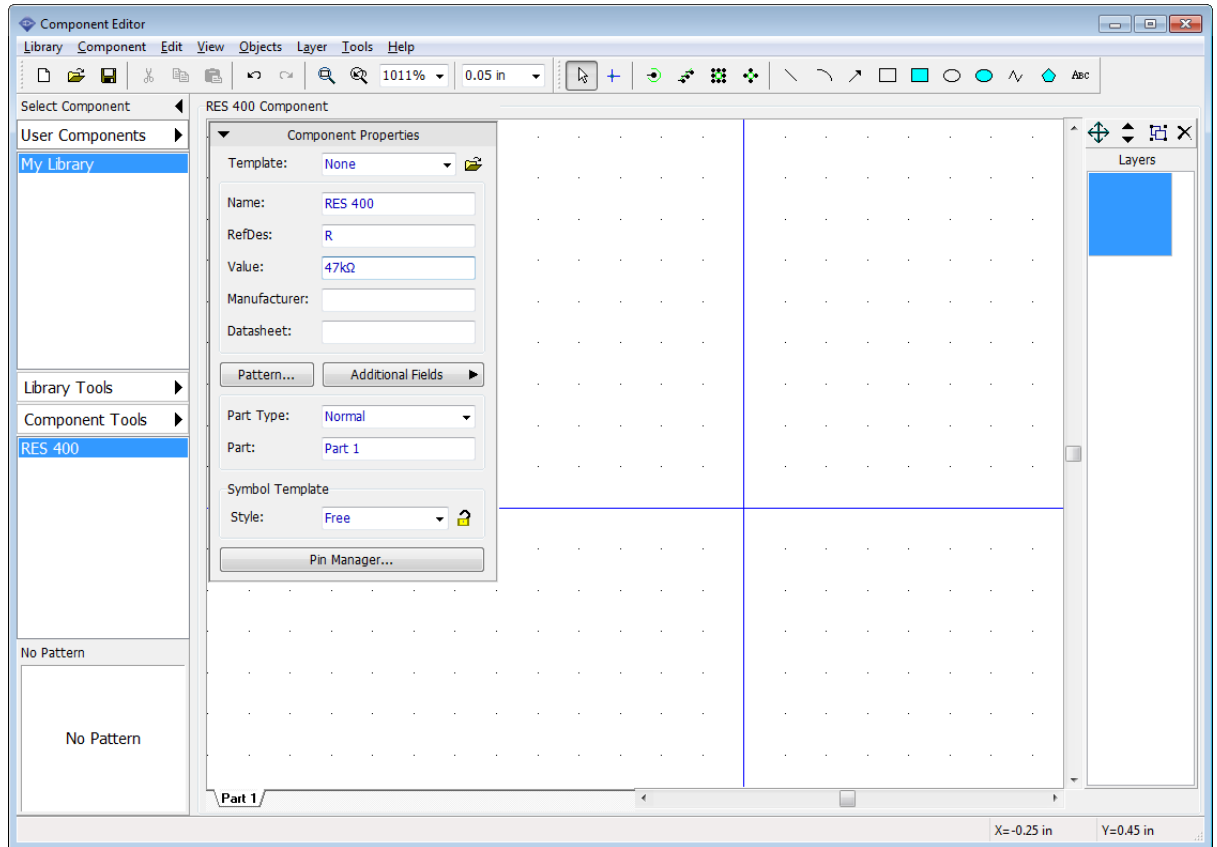

### Place pins

Select the Place Pin tool on the Objects toolbar ( button), then move the mouse cursor to the design area, and place two pins with left clicks. Rotate one pin 180 degrees, (select it, and press *Ctrl+R* twice), make sure that pins are placed by the 0.1-inch grid. Now change the grid to 0.05 inch, select the **Rectangle** tool, and place graphics for the resistor.

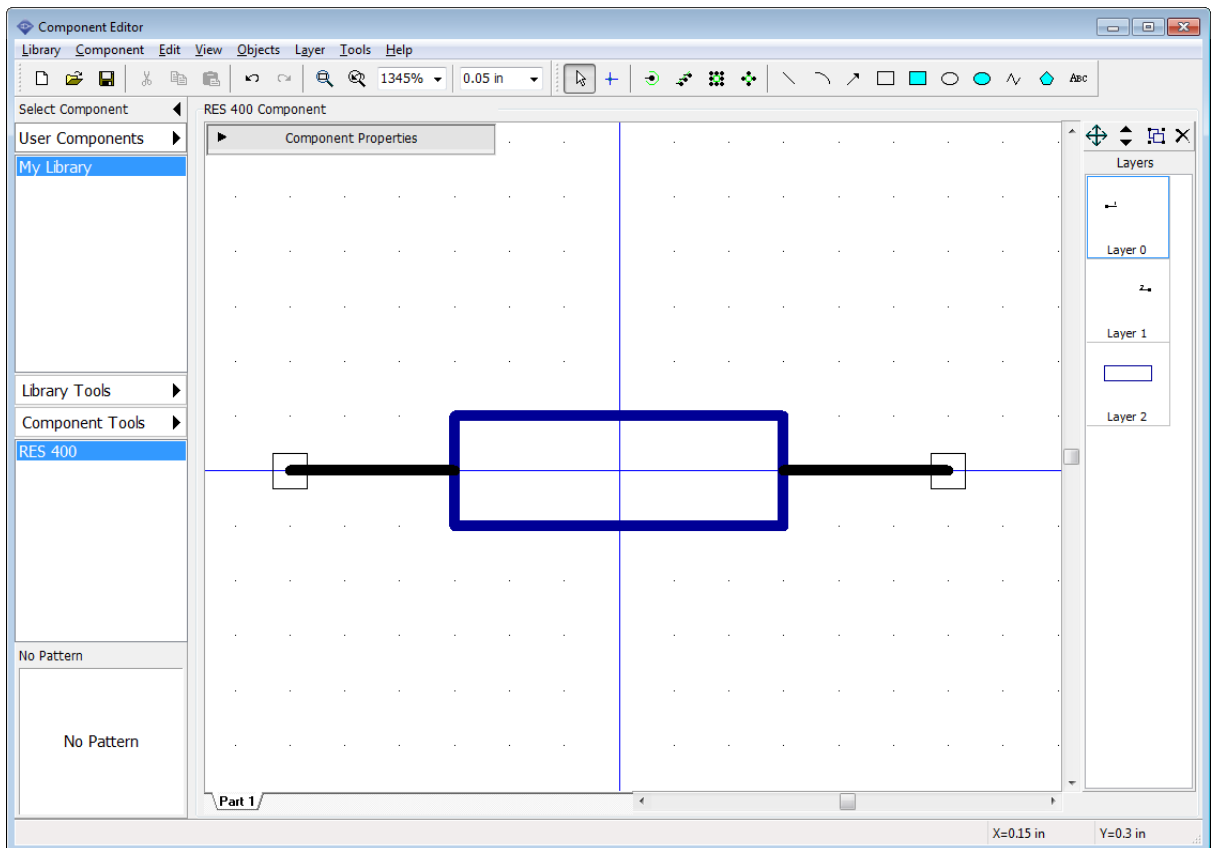

Notice that you can move pin(s) using the drag-and-drop method. If you want to move or rotate several pins, select them first. You can use the **Align Objects** tool for automatically placing several objects in a row or column. Select objects on the design area, then select **Align Objects** from the submenu to set up alignment direction and spacing.

### Attach pattern

The symbol of the resistor is ready, but the component is not ready yet. We should attach a pattern to this symbol, otherwise, we will not be able to generate the circuit board from the schematic with this resistor. Select "Component \ Attached Pattern" from the main menu or press **Pattern** on the **Component Properties** panel. We need to connect this symbol drawing with a pattern drawing created before in the Pattern Editor. Select **User Patterns** library group (because, as you remember, we've saved the pattern library in that group (see "[Designing Resistor](#)"<sup>[96]</sup> topic of this tutorial). There is only one library in that group. Select it, and select RES 400 pattern that we've created earlier.

*Notice that DipTrace automatically creates pin-to-pad connections by numbers. You can review and reassign them if necessary. Connections should be like in the picture below.*

To create or redefine pin-to-pad connections, hover over the pin, left-click it, then move the mouse to the corresponding pad, and left-click it to connect them. To delete a connection, right-click on the pin or pad, and select **Disconnect pin from pad** item from the submenu. When you move the cursor over one of connected pins/pads, both are highlighted. If a component is more complex, use the **Pin to Pad** table (select pin and type in the corresponding pad number into the **Number** field below).

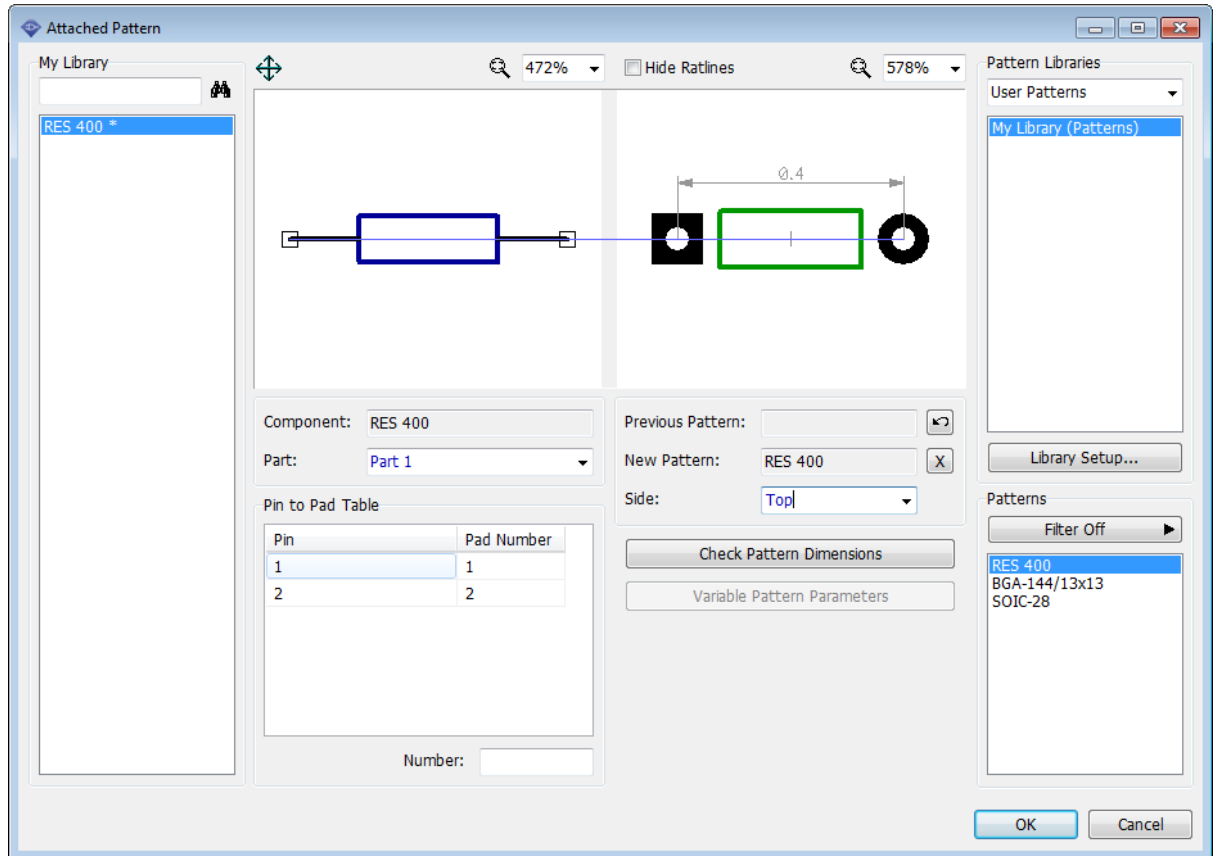

Pin numbers (therefore component's pin to pad connections) can be changed with the **Pin Manager** (select "Component \ Pin Manager" from the main menu) or in the Pin Properties dialog box.

If the current pattern is wrong, you can undo to the previous one or delete it by pressing the corresponding buttons (Previous Pattern, New Pattern). Change pattern side with the corresponding drop-down list.

All components of the library are in the left part of the dialog box, this allows the user to attach patterns to several components at a time. However, we don't need this now. Our Library has only one component.

Everything looks good. Press **OK** to close the Attached Pattern dialog box. The resistor is ready and contains both schematic part and PCB pattern with 3D Model.

Save component library. Press the **Save** button on the Standard toolbar, select location (not in the folder with standard libraries), enter a file name, and press **Save**.

Notice that this is the file with \*.eli extension, this means that this is component library file.

### 4.2.3 Designing a capacitor

Select "Component \ Add New to "My Library" from the main menu to add a new component to the library.

We will design capacitor using the 2 sides component style (Style box on the Component Properties panel); type in the component's name "CAP", RefDes – "C", Value – "2μF". Change component width and pin spacing to 0.1 inch, left and right pins to "1".

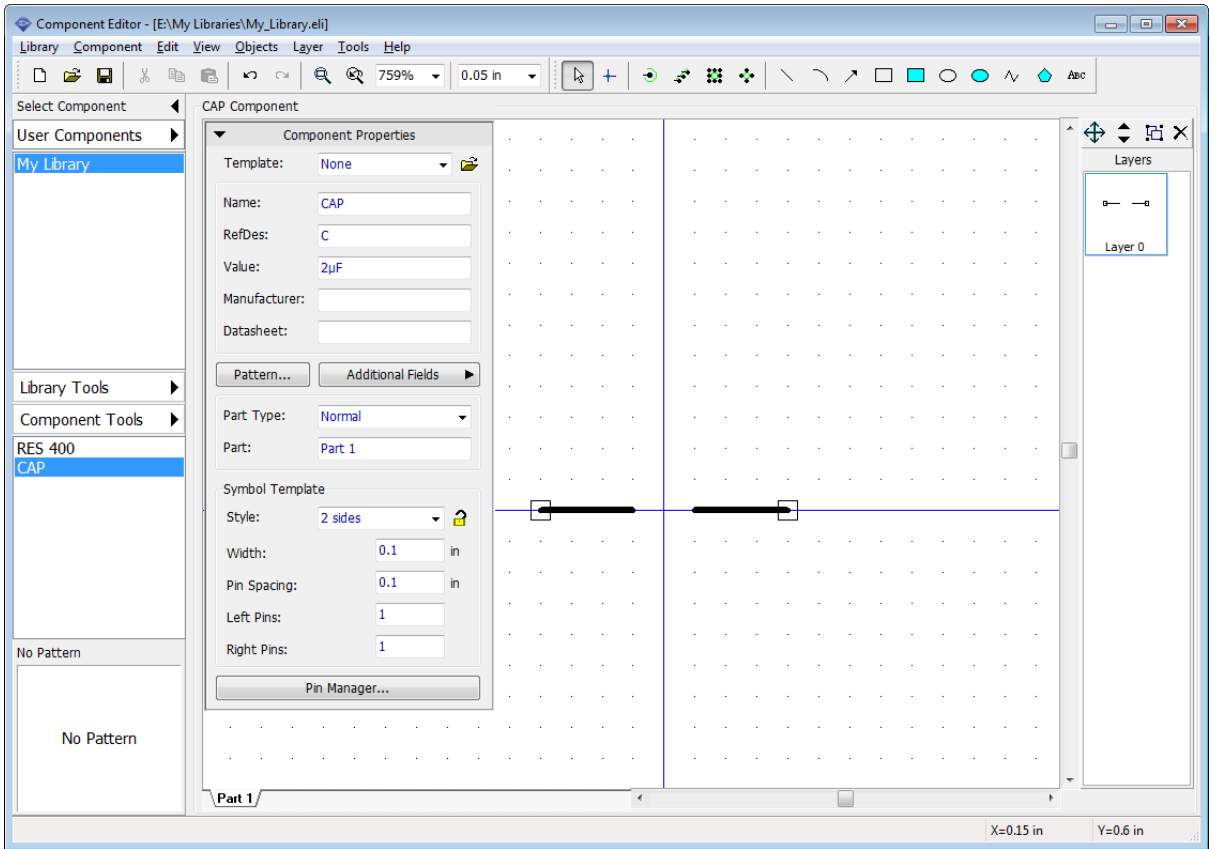

Now please minimize the Component Properties panel, change the grid size to 0.012 inch, and draw the capacitor's graphics, using three lines and one arc.

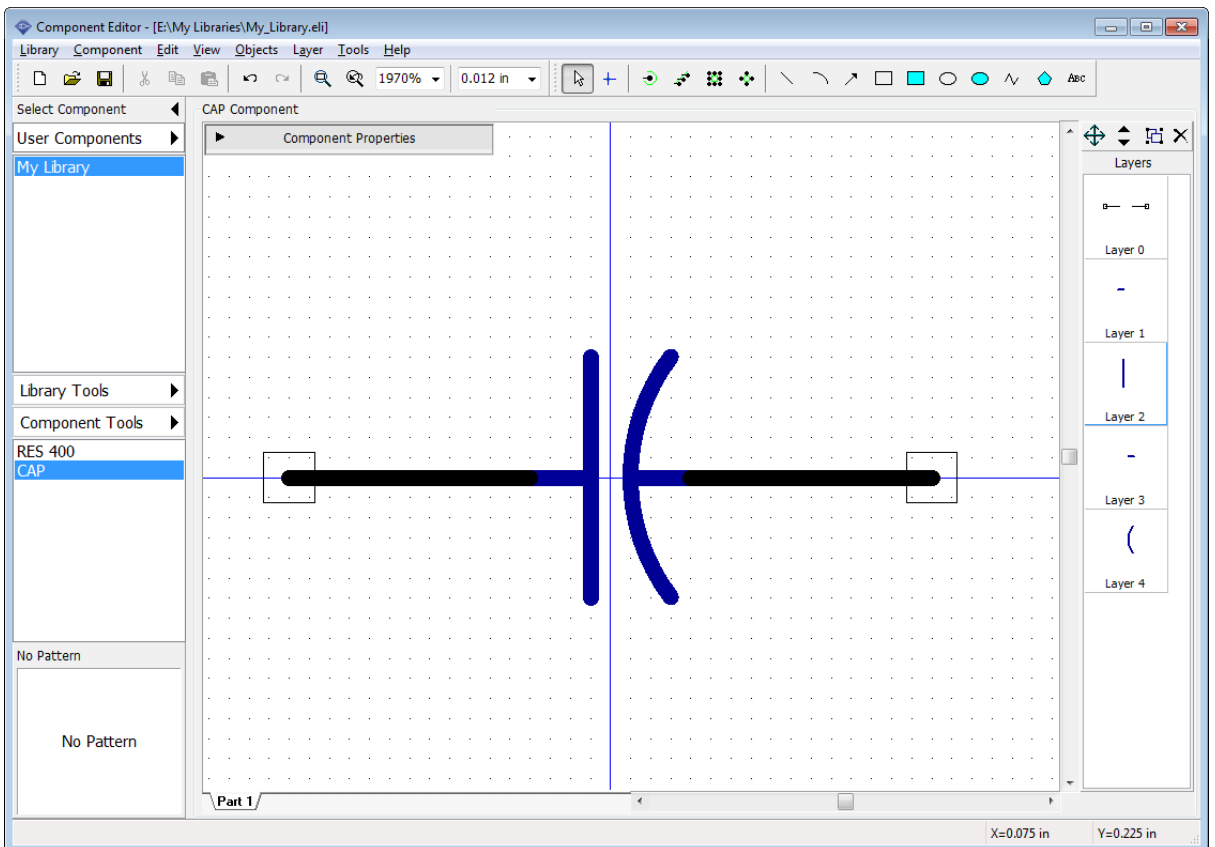

Show pin names for the component symbol, select pins (or select all using *Ctrl+A* hotkeys), right-click on one of them, and choose **Pin Properties** from the submenu. In the Pin Properties dialog box, check the **Show Name** box, and press **OK**.

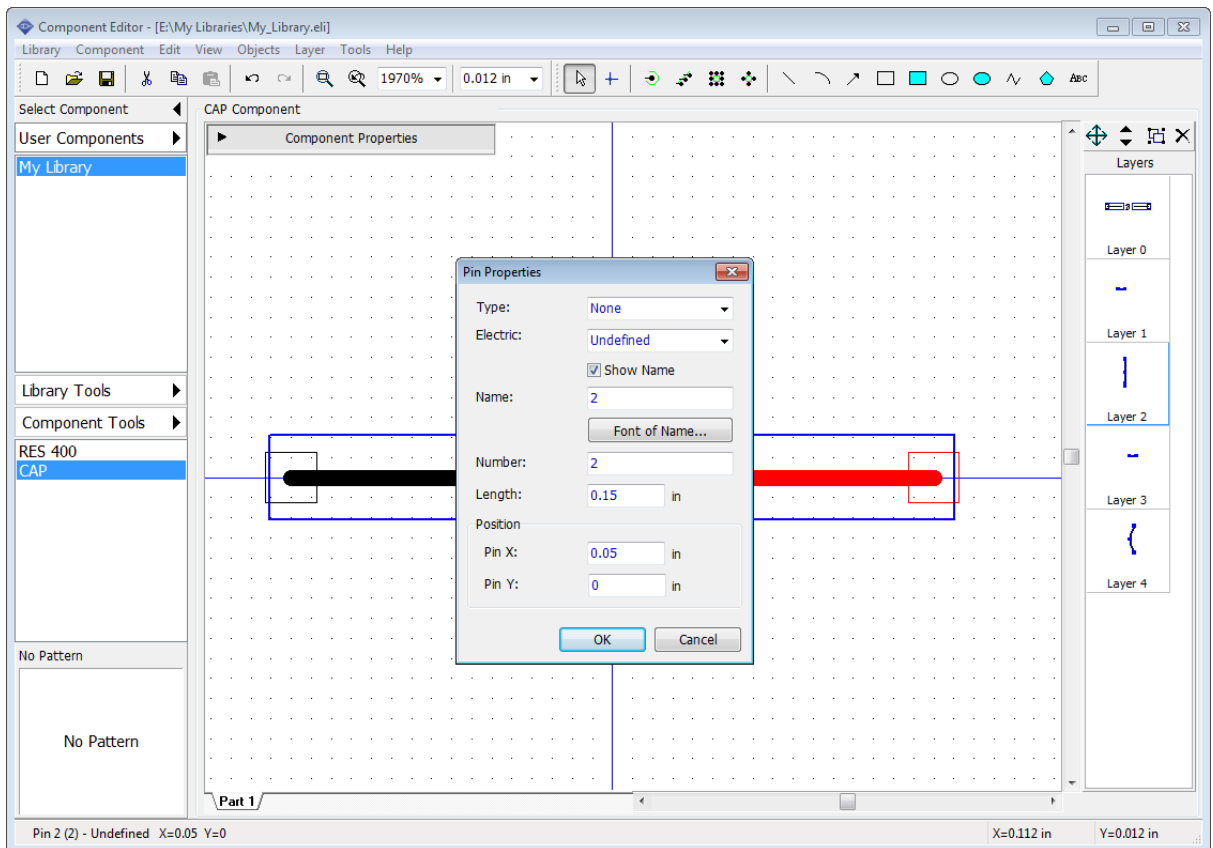

Now you can see the pin names but they are in wrong places (probably overlaying each other) and you need to move them. Select "View \ Move Tool" from the main menu or press *F10*, then hover over the pin names, and drag them to new locations one-by-one, then right-click to return to the Default mode.

*Notice that you can use such method to move pin names, numbers and part attributes in Schematic.*



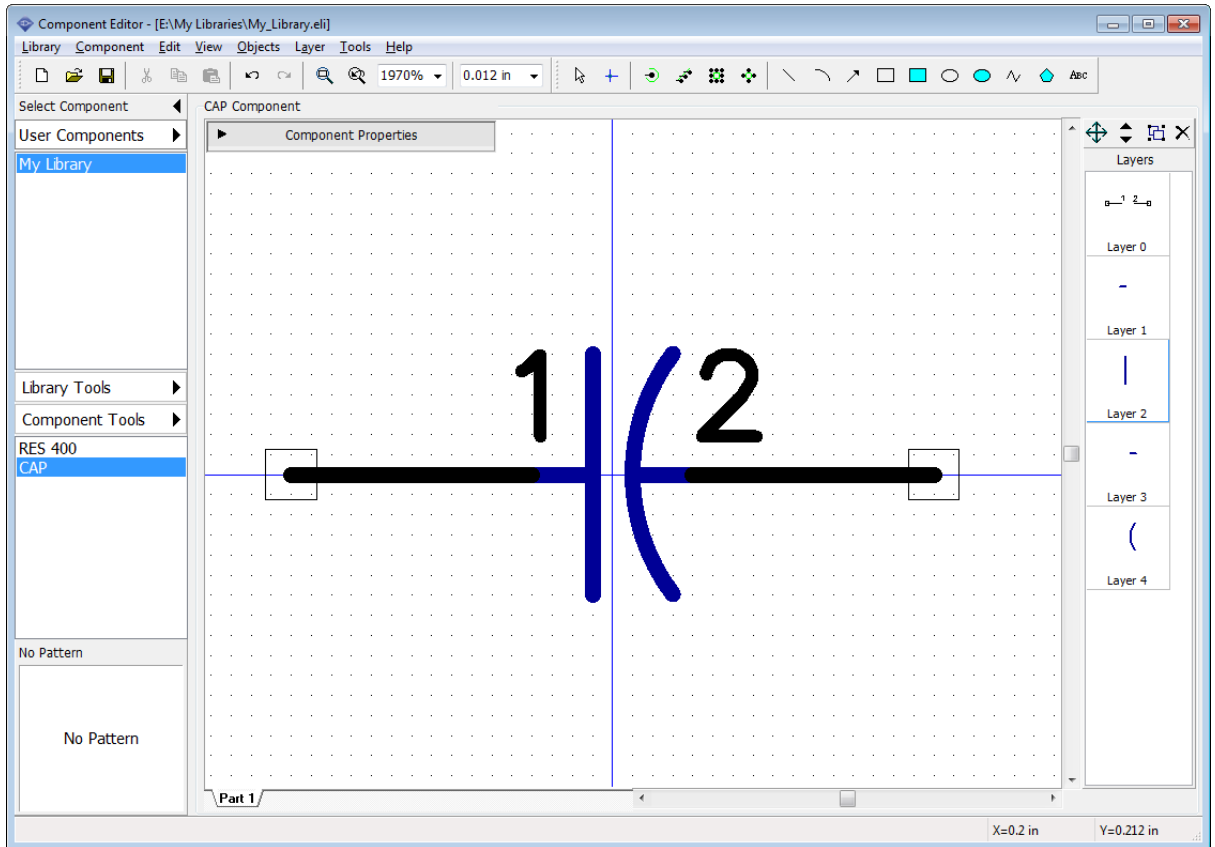

You can show inversion line in the pin name, just hover over the pin with your mouse, right-click, and select **Pin Name** from the submenu, type in "normal ~invert" text, and press **OK**, then move the pin name using the move tool (*F10* hotkey). The Tilde Symbol (~) in the pin name starts and ends the inversion, so using it you can define the inversion for separate parts (signals) in the pin names.

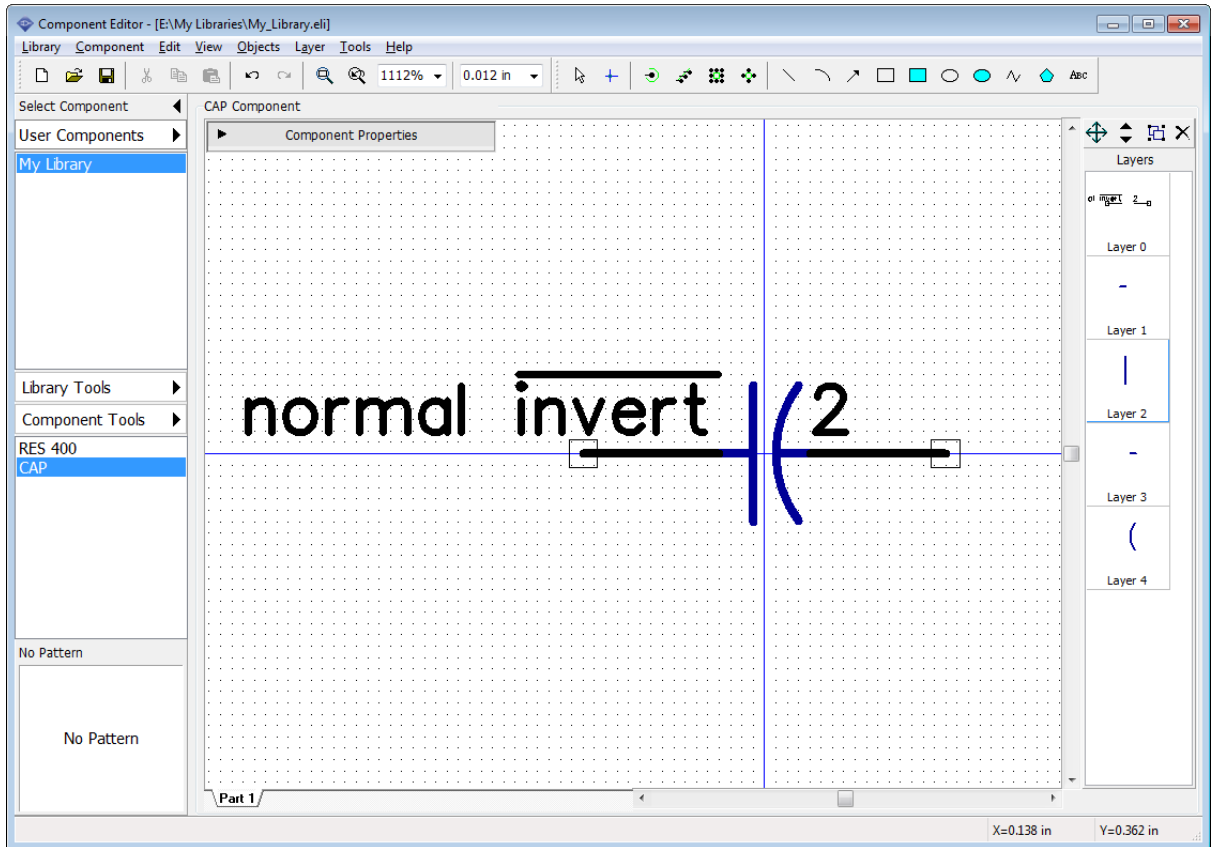

You probably don't need to see the pin names for simple passive components like capacitors.

Select "Component \ Pin Manager" from the main menu to open the **Pin Manager** dialog box and change "normal ~invert" pin name back to "1". Now hide pin names for both pins: select pin row in the table, and uncheck **Show Name** box at the bottom of the dialog box. Close the Pin Manager.

*Notice that you can change pin numbers (i.e. related pads), coordinates, length, type, and electric type of pins in the **Pin Manager** dialog box.*

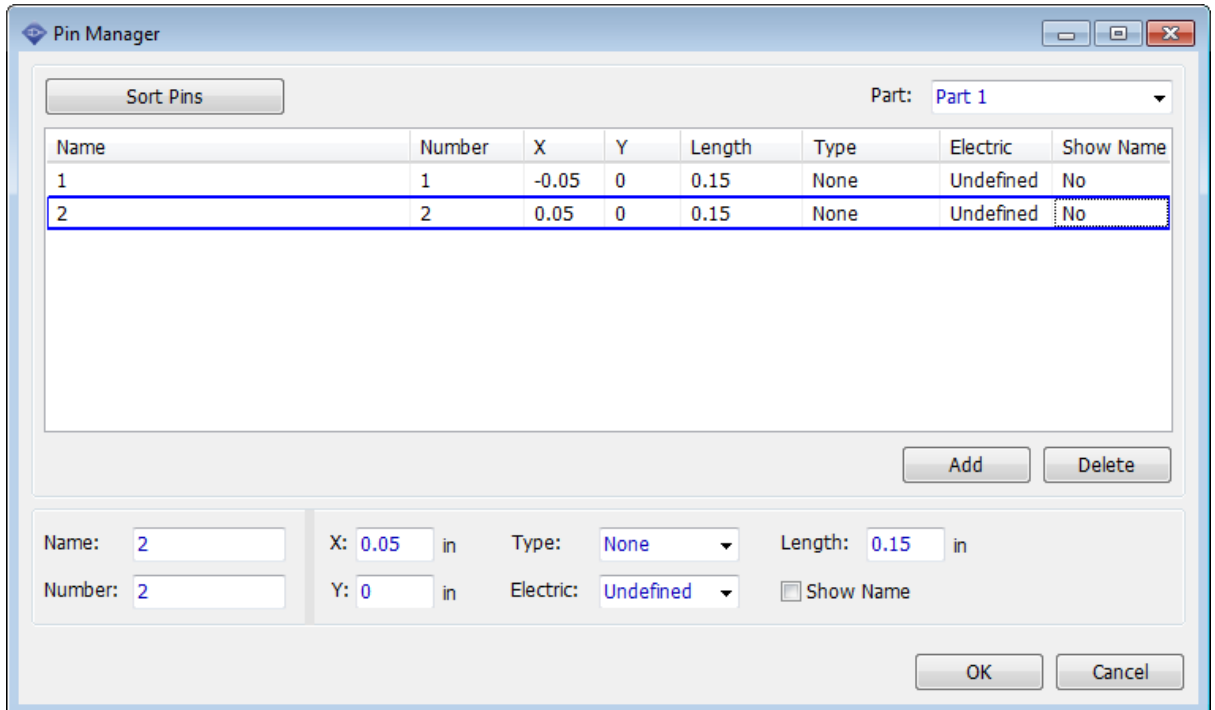

In the Component Editor you can set individual show/hide pin numbers settings for current component ("Component \ Pin Numbers" from the main menu) and common program settings (the same as in the Schematic) in "View \ Pin Numbers \ Show" from the main menu.

Let's show capacitor's pin numbers. If you need to move pin numbers, use the Move Tool (*F10*).

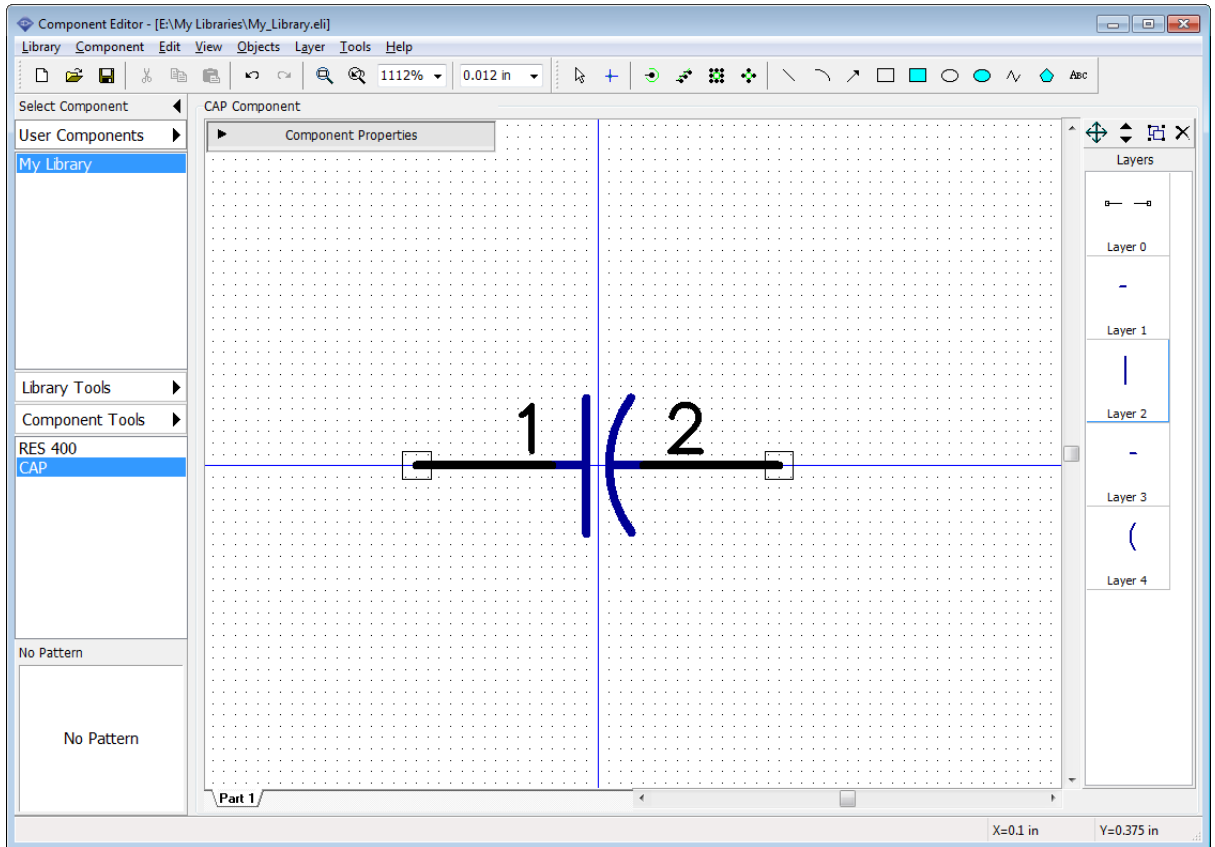

The next step is attaching a pattern to the capacitor. Open **Component Properties** panel and press **Pattern** button. We did not create a pattern drawing for this component because we will take an appropriate pattern from the standard DipTrace libraries. Select the **Patterns** library group, then select CAP library below, and CAPPR-2.54/5.08 from the list of patterns. You can use the search filters.

Pin-to-pad connections assigned automatically are good.

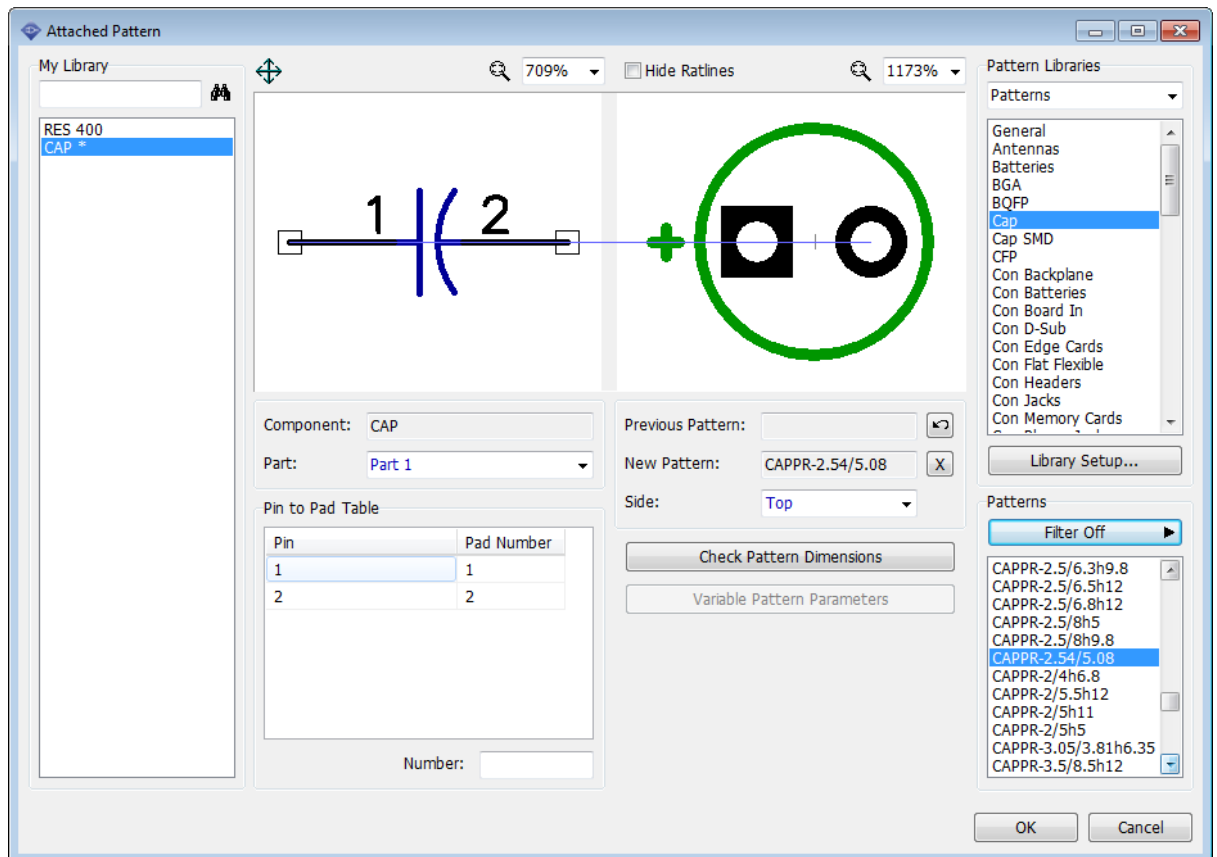

Press **OK**. The capacitor is ready. Save the changes.

#### 4.2.4 Designing VCC and GND symbols

In this lesson, we will practice in creating **net ports** by designing VCC and GND symbols.

##### VCC

Press **Component Tools**, then select **Add New Component to "My Library"**, type in "VCC" in the **Name** field on the **Component Properties** panel, and select **Net Port** in the **Part Type** drop-down list.

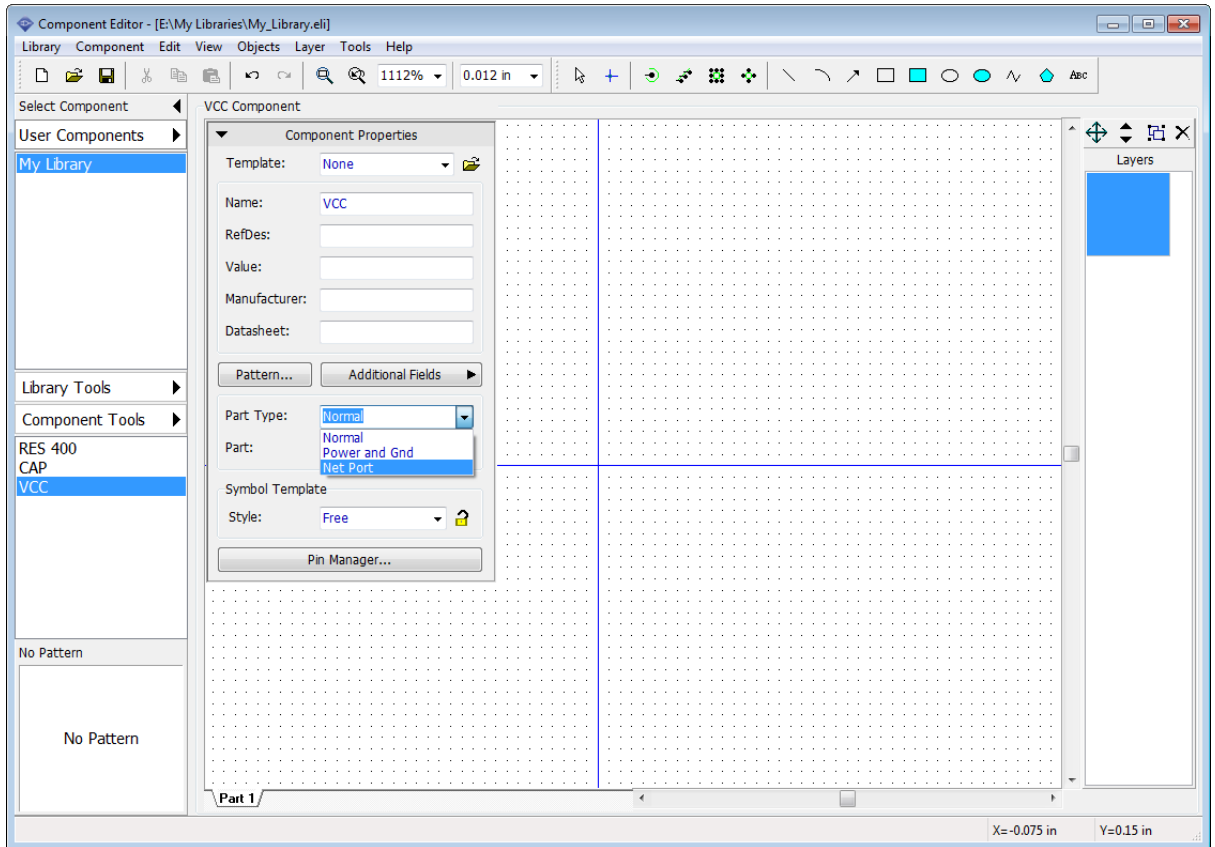

Minimize the Component Properties panel, then press the **Place Pin**  button on the Objects toolbar and place a single pin, rotate it vertically (select it, and press *R* hotkey). Select the line tool on the Drawing toolbar and draw a line like in the picture below, use 0.05-inch grid.

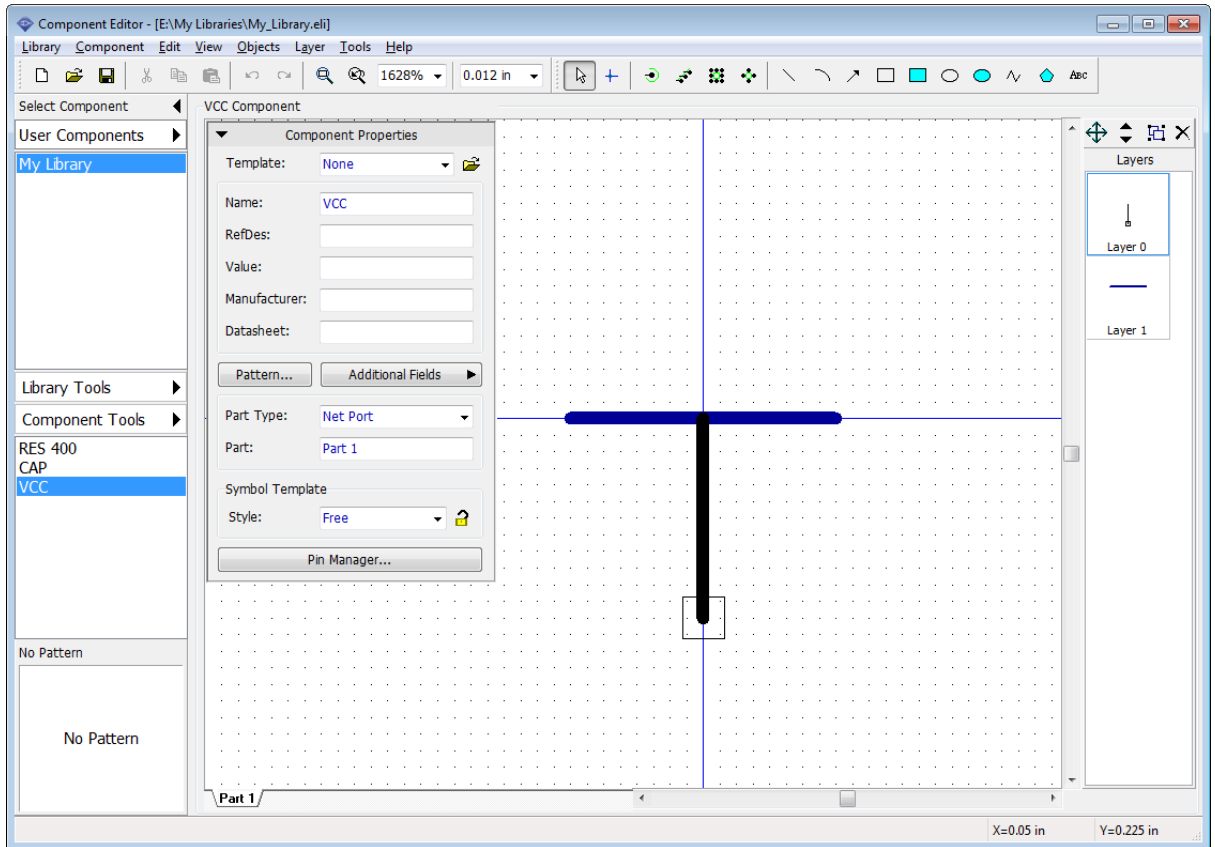

Hide the pin number if it is visible, select "Component \ Pin Numbers \ Hide" from the main menu. Pin number for the single-pin component looks kind of weird. VCC symbol is ready.

### GND

Now add one more component (*Ctrl+Ins* hotkeys), and create a GND symbol the same way like the VCC symbol.

Select "Edit \ Center Symbol" or press *Ctrl+Alt+C* for GND because in our case its origin is not in the center, so you have to center it to make component's origin hidden by default in the Schematic. Use 0.012-inch grid to draw a GND symbol's graphics.

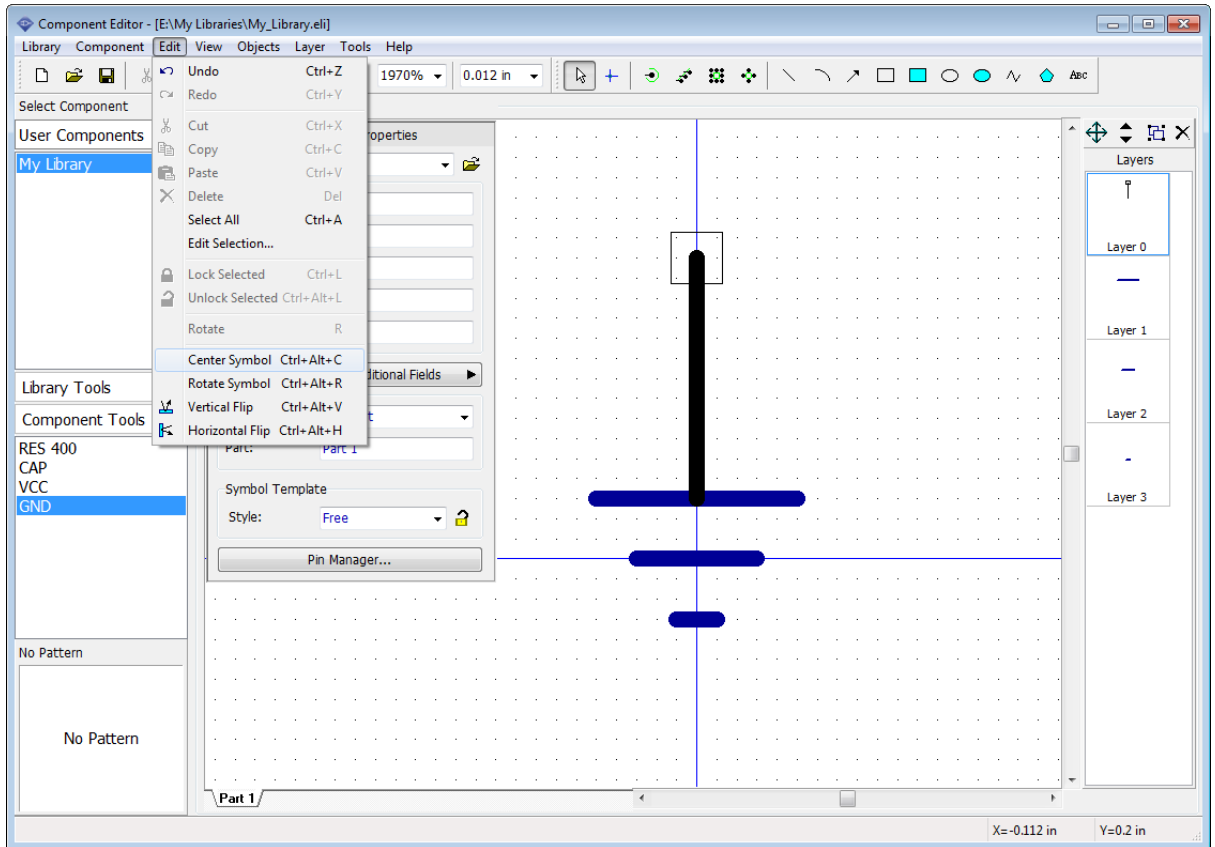

*Notice that net ports do not need patterns. This special type of components is used only in Schematic to connect wires without visual connections, net ports do not exist on the circuit board.*

Save the library file.

#### 4.2.5 Designing a multi-part component

Despite being represented as a single physical package on the circuit board, some electronic components have multi-part schematic symbols. Building a multi-part schematic symbol involves a bit different technique.

##### Creating a symbol

We will design a simple multi-part component with four "And-Not" symbols, a power part, and attach DIP-14 pattern, which is available in the standard libraries.

Add new component to the library, i.e. select "Component / Add New Component To Library" from the main menu. Enter the name and Reference Designator.



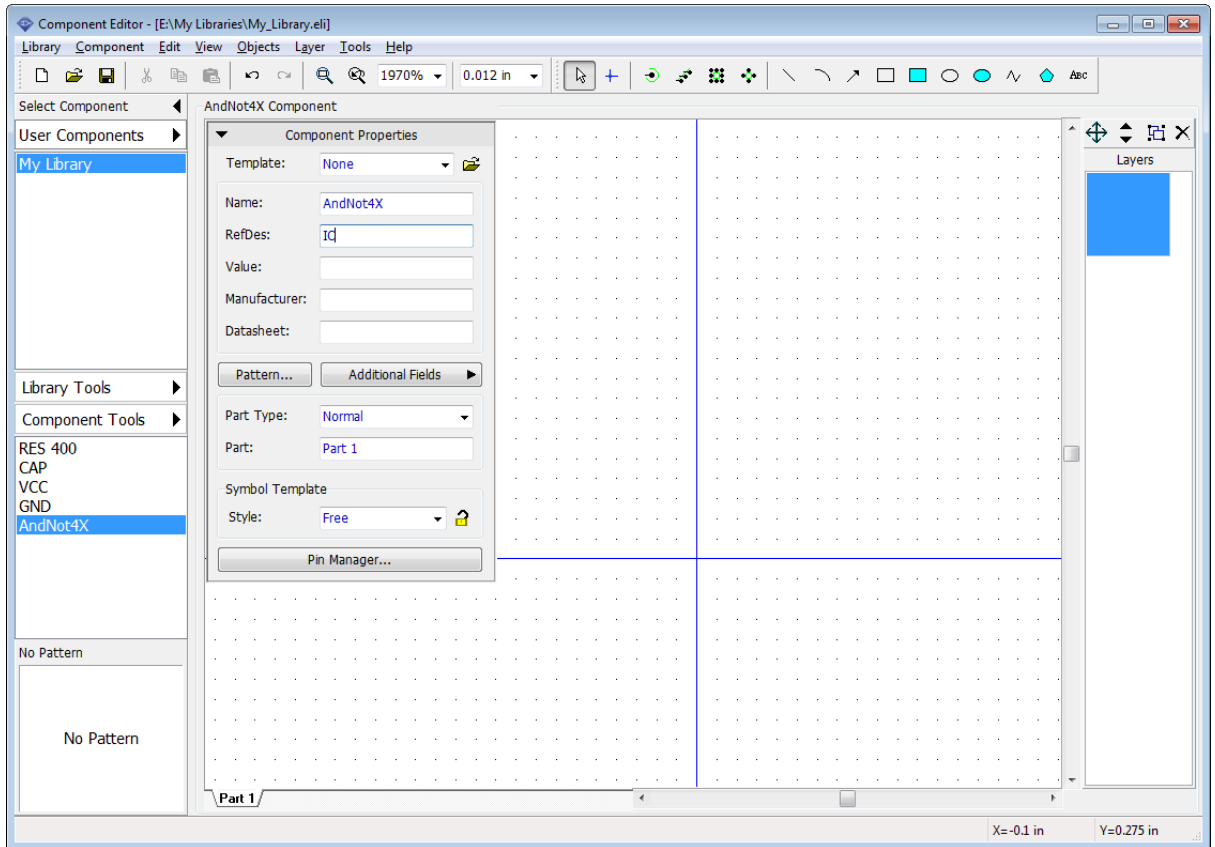

## Creating parts

DipTrace allows for creating multi-part components using separate or similar parts. The only difference between these is that similar parts share the same layout of pins and symbol drawing, except the pin numbers (i.e. related pads). We will proceed with similar parts, which, by the way, can be grouped later in the Schematic.

Each part of the multi-part component can be Normal, Power and Ground, or Net Port. Power parts and power nets can be hidden in the schematic capture. Only one power part per component.

We will design a component with 4 similar AndNot gates (parts) and one power part that has a different layout (created separately from the similar parts). Select "Component \ Create Similar Parts" from the main menu, type "4" in the pop-up dialog box, and press **OK** to apply. Tabs with the part names have appeared in the bottom-left of the design area (like sheets in the Schematic).

*Similar parts are created based on the currently selected part. They share the same name and layout of pins.*

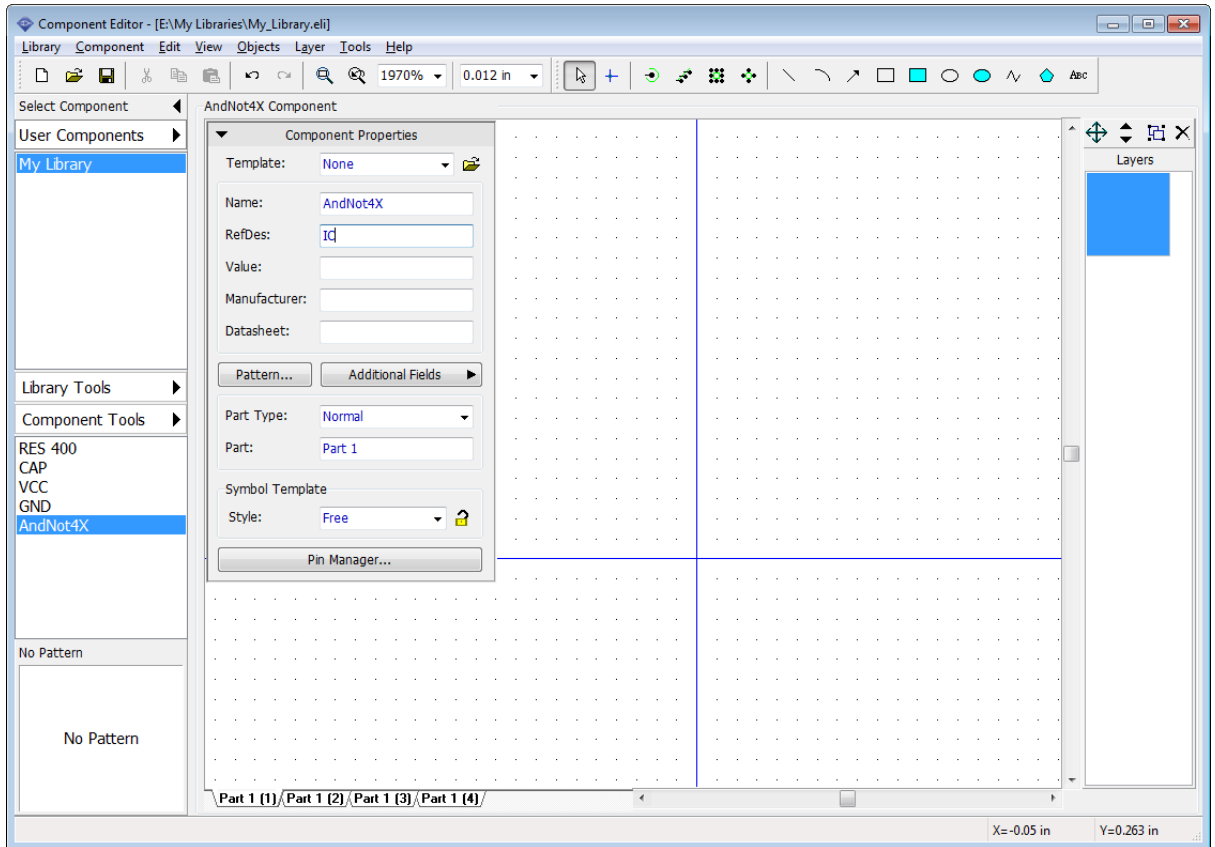

Now you can see the following 4 parts: Part 1 (1), Part 1 (2), Part 1 (3), and Part 1 (4). All similar parts have the same part name. Change it to "AN" in the **Part** field on the **Component Properties** panel.

The power part for the component is missing. Power part has a symbol different from the logic gates, this is why we will create it as a separate part (not in the "AN" group of similar parts). Select "Component \ Add New Part" from the main menu to add a single part to the component, select new part tab (Part 1) in the bottom-left of the design area, and rename it to "PWR".

*Notice that new part is a separate part and does not belong to "AN" group.*

Start designing a component with the power part. On the **Component Properties** panel specify **Style: IC - 2 sides**, **Width: 0.3 inch**, **Height: 0.25 in**, **Left Pins: 2**, **Right Pins: 0**, then select **Power and Gnd** from the **Part Type** drop-down list. Make general component pin numbers visible ("View \ Pin Numbers \ Show" from the main menu), if they are hidden.

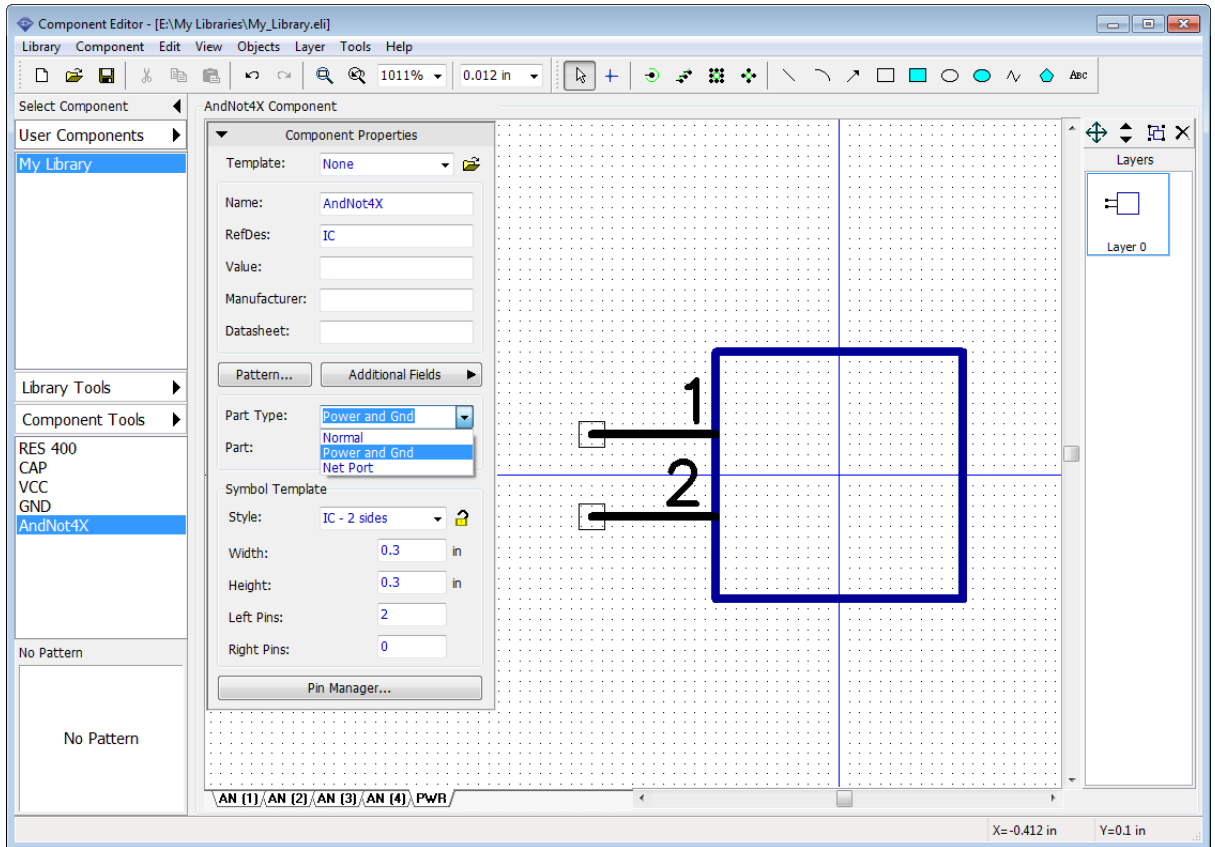

Press the **Pin Manager** button on the **Component Properties** panel, and change pin names to "VCC" and "GND", pin numbers to "14" and "7", electric type to **Power**, the **Show Name** box should be checked for both pins. Notice that you can change Type, Show Name and Length parameters for multiple pins.

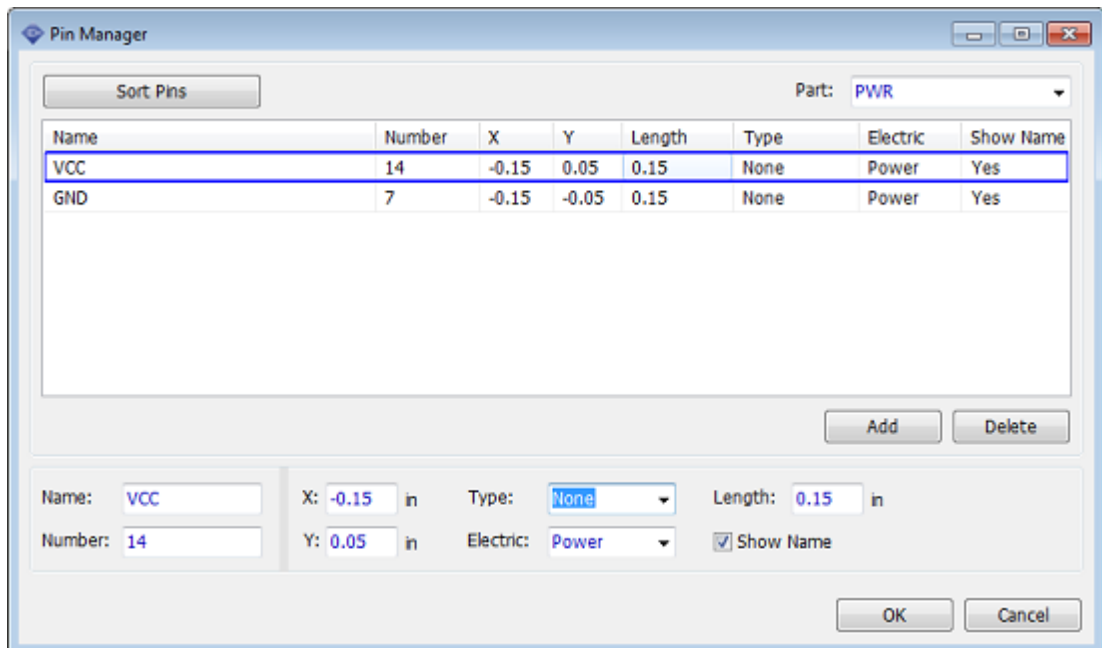

Pin Manager dialog box itself and the width of the rows are resizable. These settings are saved when you close the program.

Now press **OK** to close the **Pin Manager** dialog box. Then minimize the Component Properties panel and see the first ready part of the component.

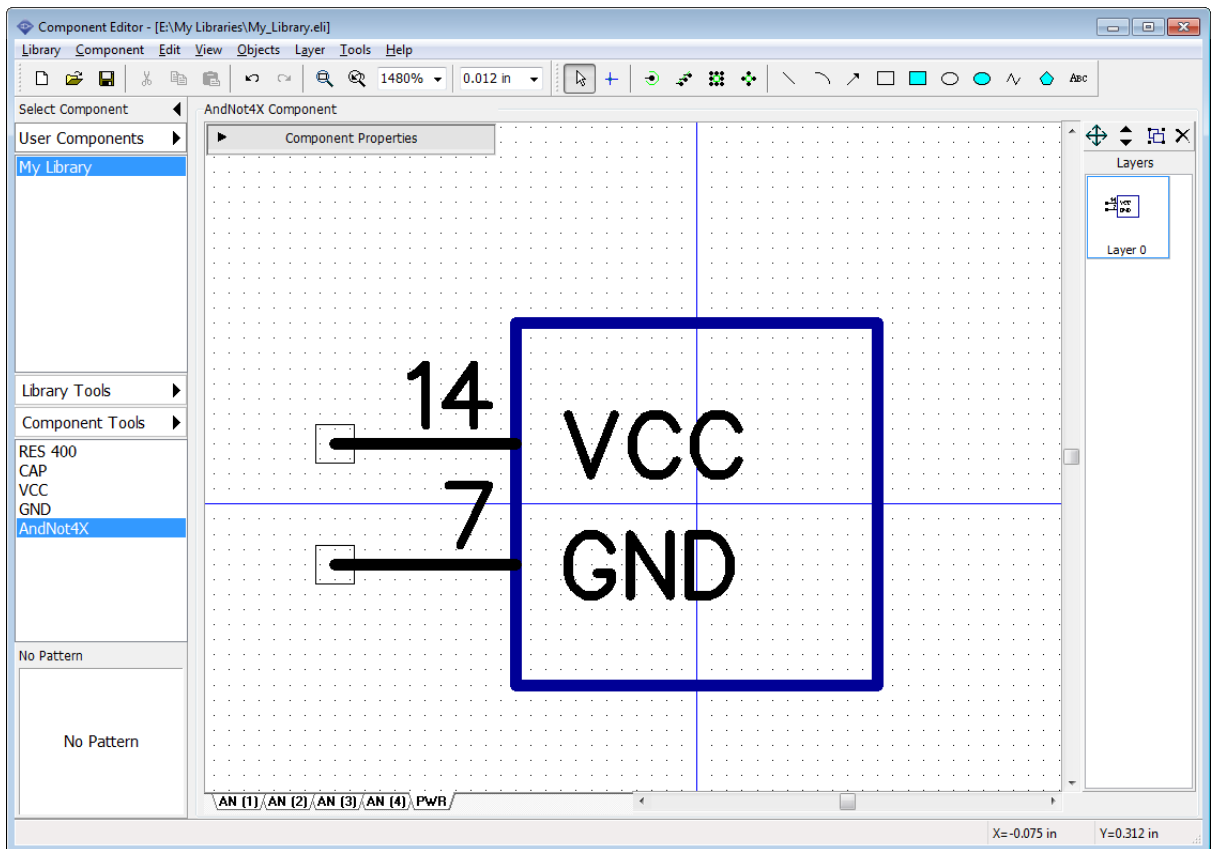

Design the other parts of the multi-part component: select one of the AN parts, maximize the **Component Properties** panel, and define the following parameters: **Style: IC-2 sides**, **Width: 0.2 in**, **Height: 0.25 in**, **Left Pins: 2**, **Right pins: 1**. Now minimize the Component Properties panel again.

Select the text tool on the drawing toolbar (  button), hover over the symbol, left-click, and type "&" character, then press *Enter* or left-click to place the text (see the picture below). Move the text if you need.

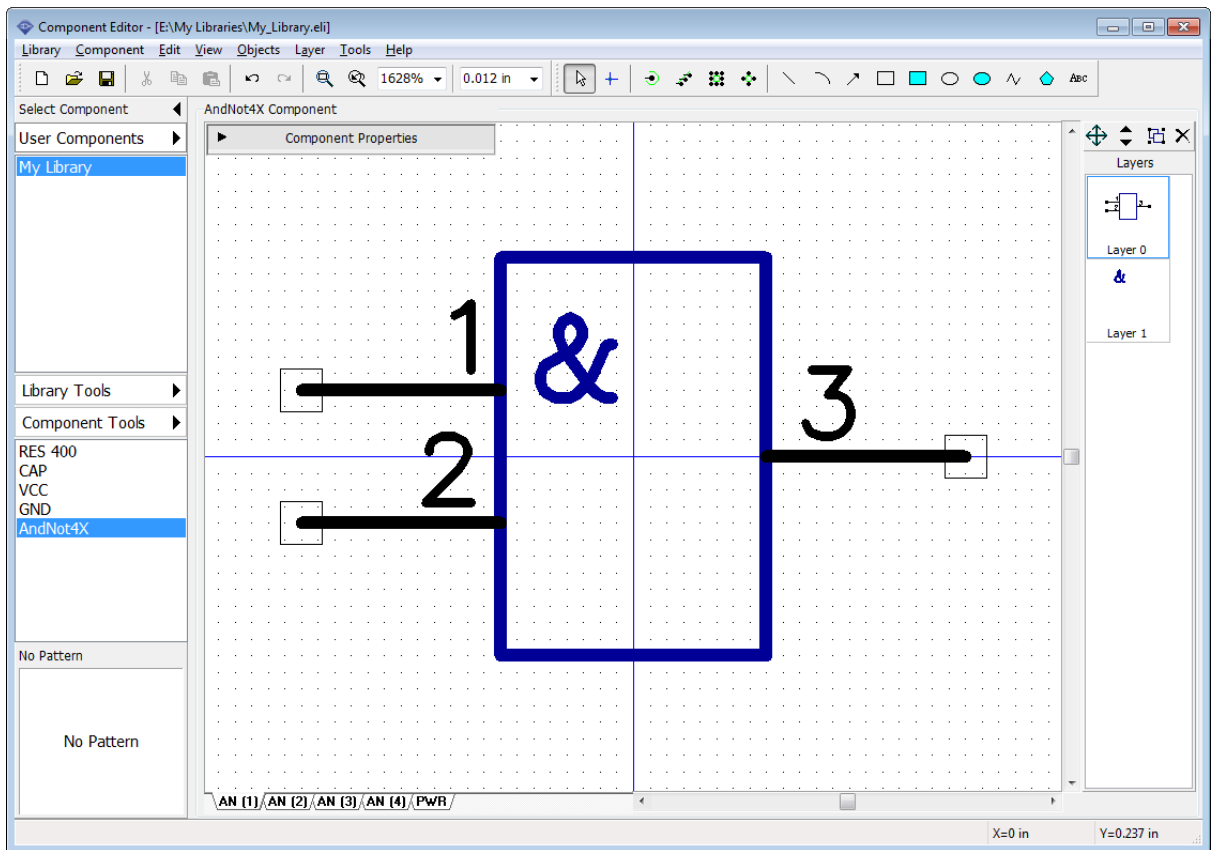

Right pin of a typical "And - Not" (Not And) part should be inverted or "Dot" type. Right-click on the third pin, select **Pin Properties** from the submenu, in the pop-up dialog box specify **Type: Dot**. Click **OK** to apply changes and close the dialog box.

*Notice that you don't need to draw another AN parts of the component if they were created as a group of similar parts, they will inherit the layout of the first part of the "AN" group.*

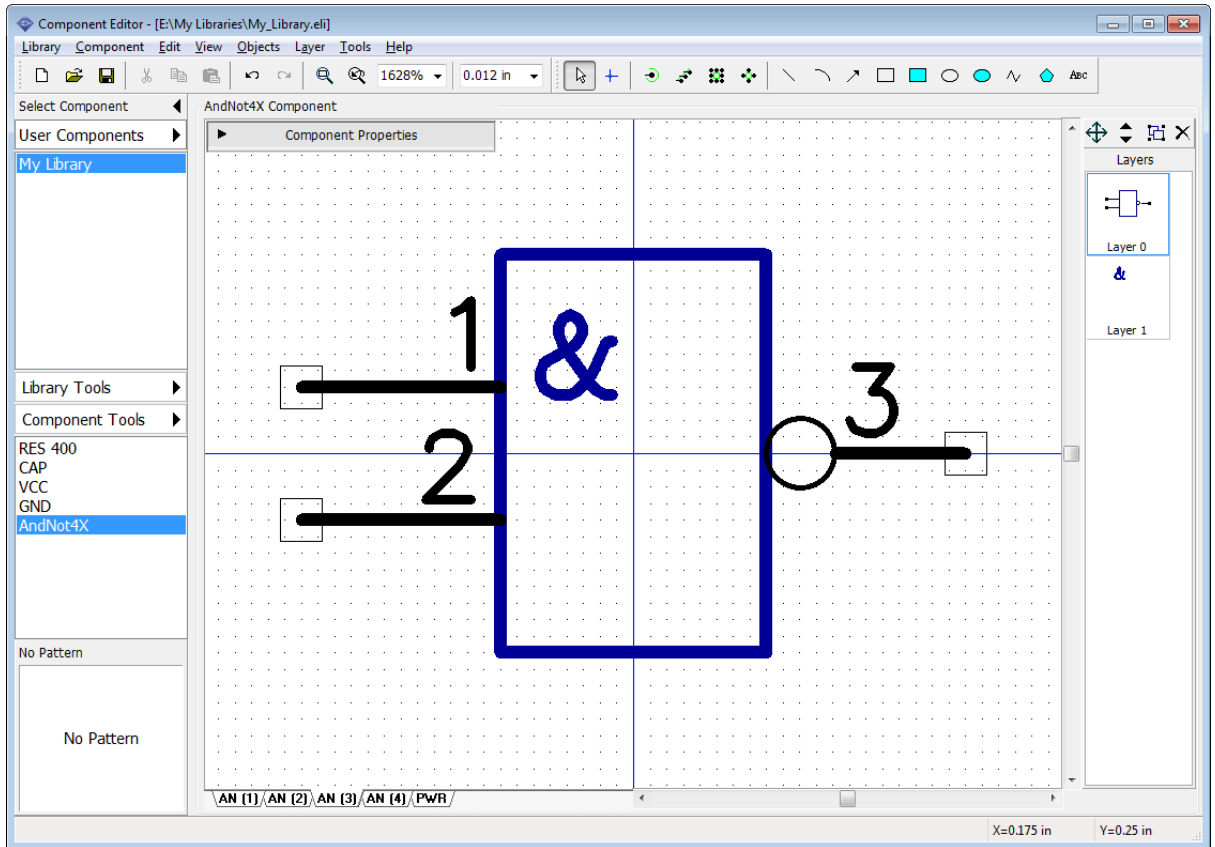

Select AN (3) or AN (4) part just to make sure that parts are the same. All parts in the group are absolutely identical but with different pin numbers.

### Pin Manager

Select "Component \ Pin Manager" from the main menu. In the **Pin Manager** dialog box select part (using the drop-down list in the upper-right), define pin numbers, then select next part and so on, until you define pin numbers for all AN parts. Use the Down arrow button or *Enter* to quickly switch to the next pin when you're typing in the Number or Name fields.

Don't forget that pin #7 is used in the GND part, therefore you should miss it while renumbering pins of the functional parts, going from pin #6 straight to the pin #8.

Please set correct Electric type (2 input pins and one output pin) for one of the parts and the other parts will inherit this automatically. Click **OK**.

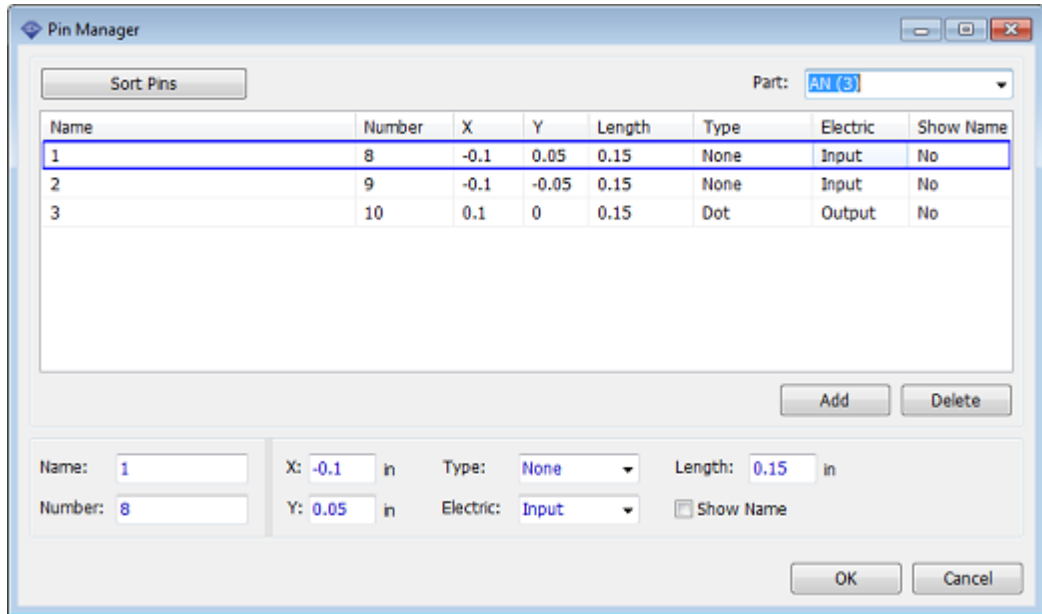

The next step is attaching a related pattern to the multi-part component. Press the **Pattern** button on the **Component Properties** panel. In the attached pattern dialog box select the **Patterns** library group (library group with all standard pattern libraries), then select **DIP** library and DIP-14 pattern in there.

*Notice that you don't need to specify pin-to-pad connections, they have been assigned automatically and should be correct, because we've specified correct pin numbers in the Pin Manager (this is why pin number array was not straight).*

Select different parts (drop-down list below the preview field) and visually check connections to ensure that they are all right. Press **OK** to attach pattern and close this dialog box.

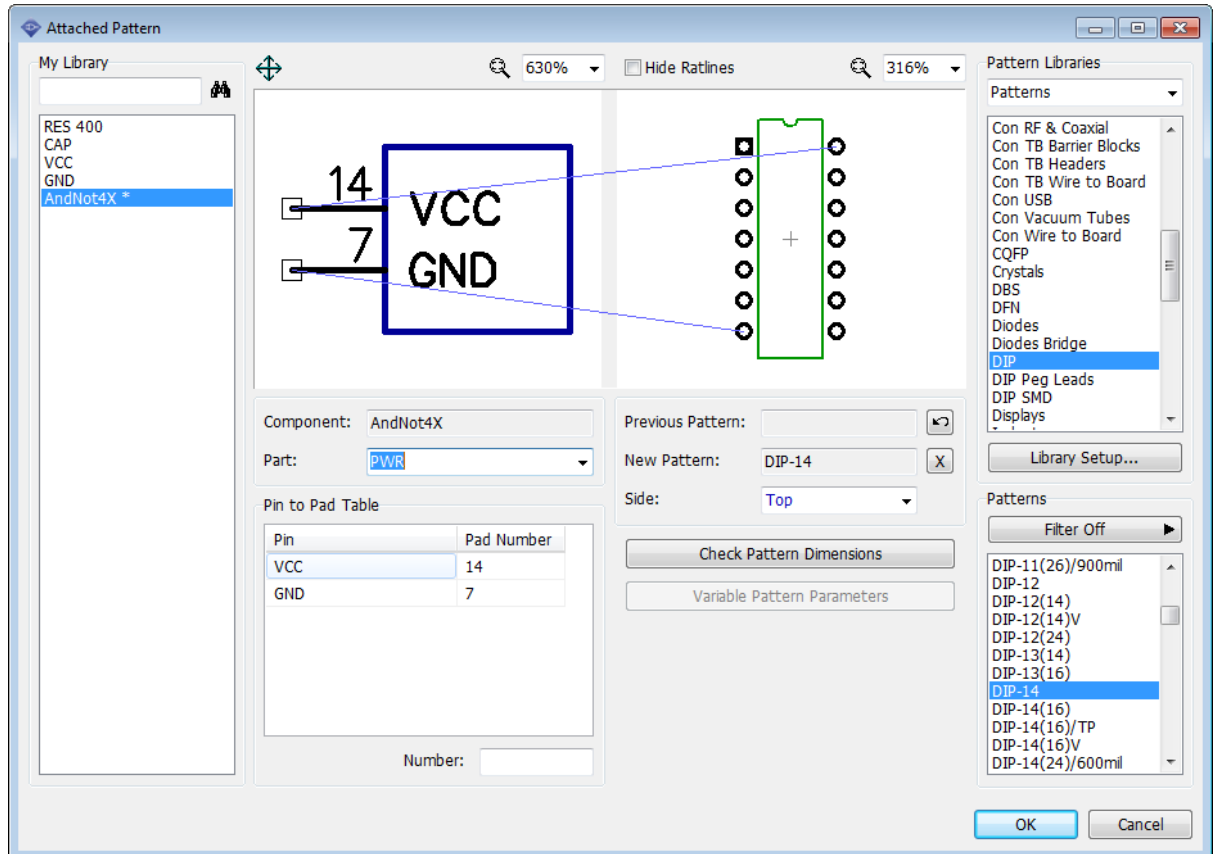

Multi-part component is ready. Save the library file.

#### 4.2.6 Using additional fields

Name, RefDes, Value, Manufacturer, and Datasheet are default component fields in the DipTrace, usually, these are what most users will ever need, but sometimes additional description or other information is necessary. In this case, you can use additional fields.

Select "Component \ Default Additional Fields" from the main menu. This dialog box allows you to specify default additional fields and their values. For example, we need to have the link for one more datasheet online: type in "Datasheet #2" into the Name box, specify **Type: Link**, enter the web address, and click **Add** button. Now this additional field will apply only to **all new components** that you will create. If you want to add this additional field to all existing and future components in this library, then press the **Add to All** button.



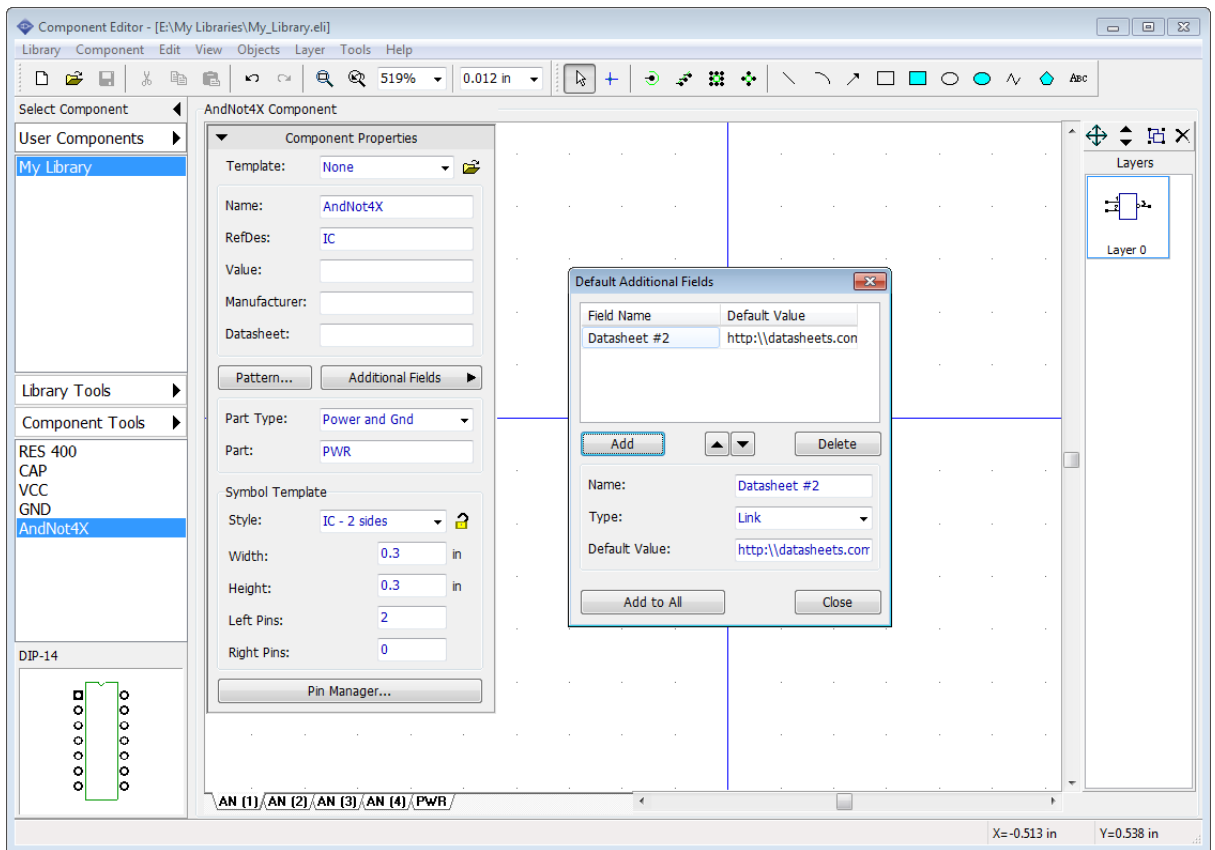

Now all components in this library will have this additional field with the datasheet link. Close **Default Additional Fields** dialog box. Select **Component Tools**, then select **Add New Component to "My Library"** or press *Ctrl+Ins*. Click **Additional fields** button to see the list of all additional fields for a new component.

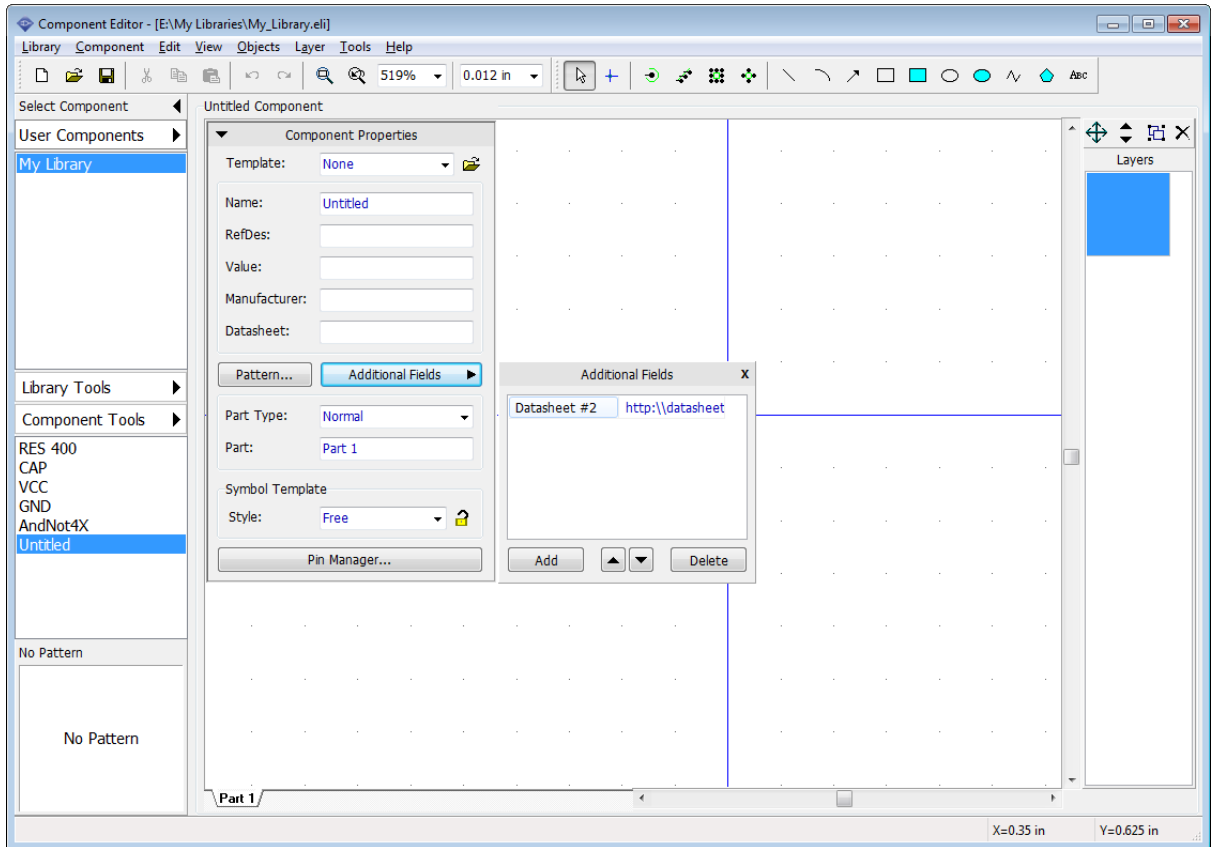

It has this **Datasheet** field.

Now make sure that **Untitled** component is selected on the Library Manager panel, right-click it, and select **Delete Components** or simply press *Ctrl+Del* to delete it. You can also select several components and delete them at a time.

You can assign custom additional fields to the component, just press the **Additional Fields** button on the **Component Properties** panel and practice a bit.

### Additional fields in Schematic

Right-click on the component with links to the datasheets on the design area in DipTrace Schematic, and select **Links** from the right-click submenu, the web browser will pop up automatically. You can assign additional fields as component markings for all or only for selected components in the DipTrace Schematic.

## 4.2.7 Designing PIC18F24K20

In this topic, we will create a real-life PIC18F24K20 component according to the datasheet and attach SOIC-28 pattern that was created [before](#)<sup>[114]</sup>.

Go to the [Microchip website](#) and search "PIC18F24K20", then select "Datasheets" on the left. Or use the direct [link](#) (however we don't guarantee that it works at the moment you read this tutorial). Go to "Pin Diagrams", the first diagram is what we need.

Switch to the DipTrace Component Editor and add a new component (*Ctrl+Insert*), type in the name "PIC18F24K20", then specify **Style: IC - 2 sides, Left Pins: 14, Right Pins: 14**, RefDes and manufacturer.

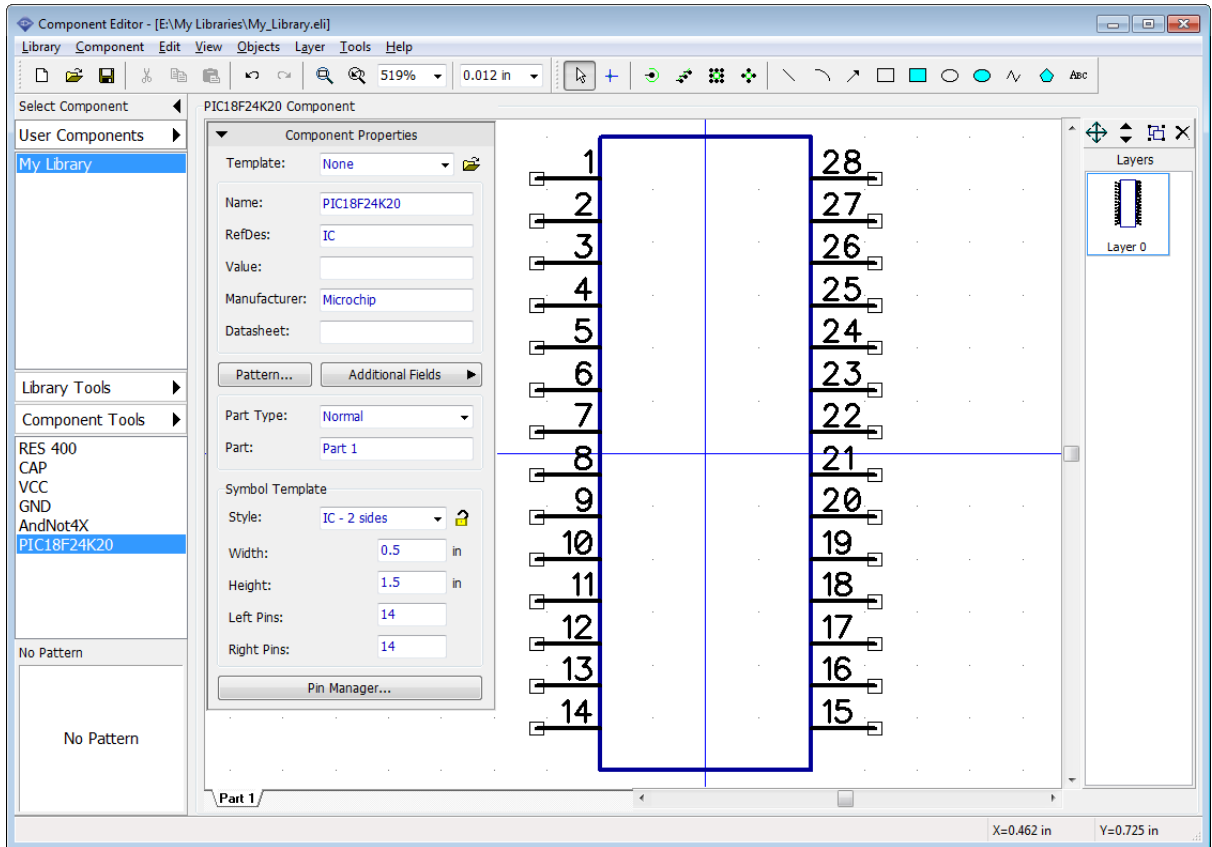

DipTrace allows the user to enter pin names manually or import them from external BSDM file (select "Library \ Import \ Add BSDL Pinlist" from the main menu). We will do this manually. Press the **Pin Manager** button on the **Component Properties** panel and enter pin names from the pin diagram in the datasheet found online. Notice that you can resize the pin manager panel and change the width of the columns (we made the **Name** column wider to see the full pin names). Also when you entered the pin name, just press *Enter* to switch to the next pin name easily.

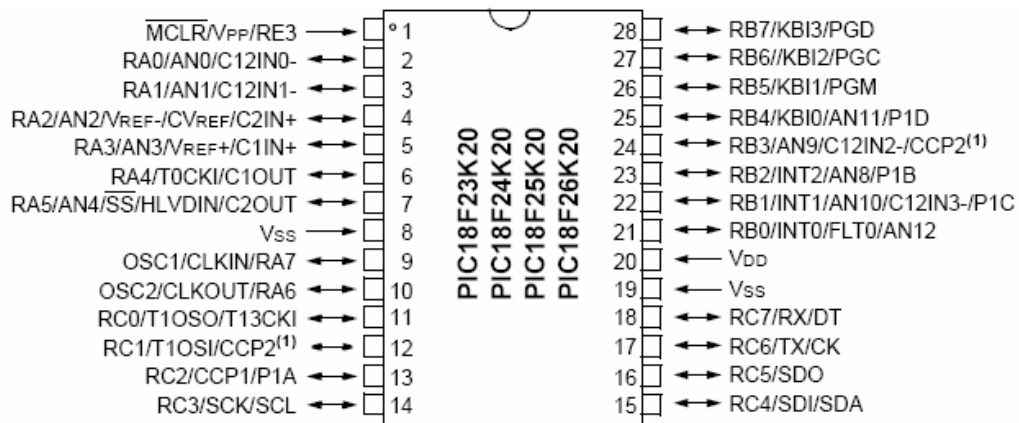

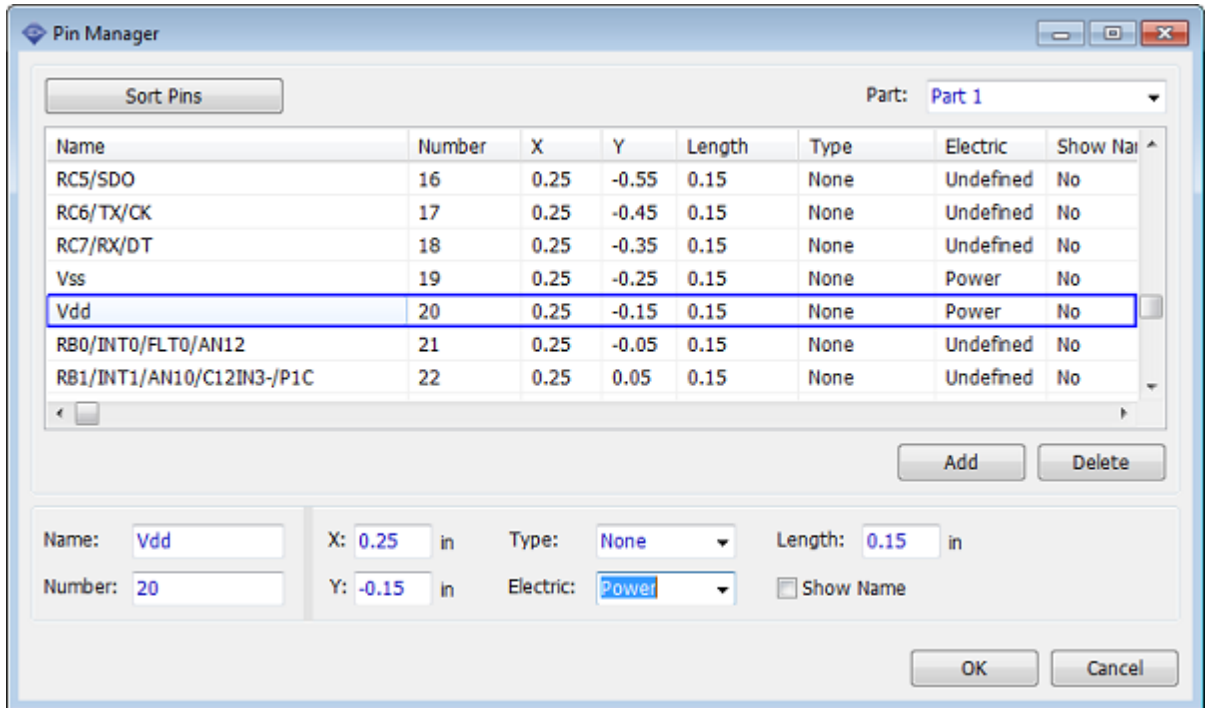

After entering all pin names, specify electric types for pins, and check the **Show Name** box for all pins of the component. Notice that you can select as many rows as you need and change certain properties at a time. Press **OK**.

Our symbol has inappropriate look, width is too small with pin names overlaying.

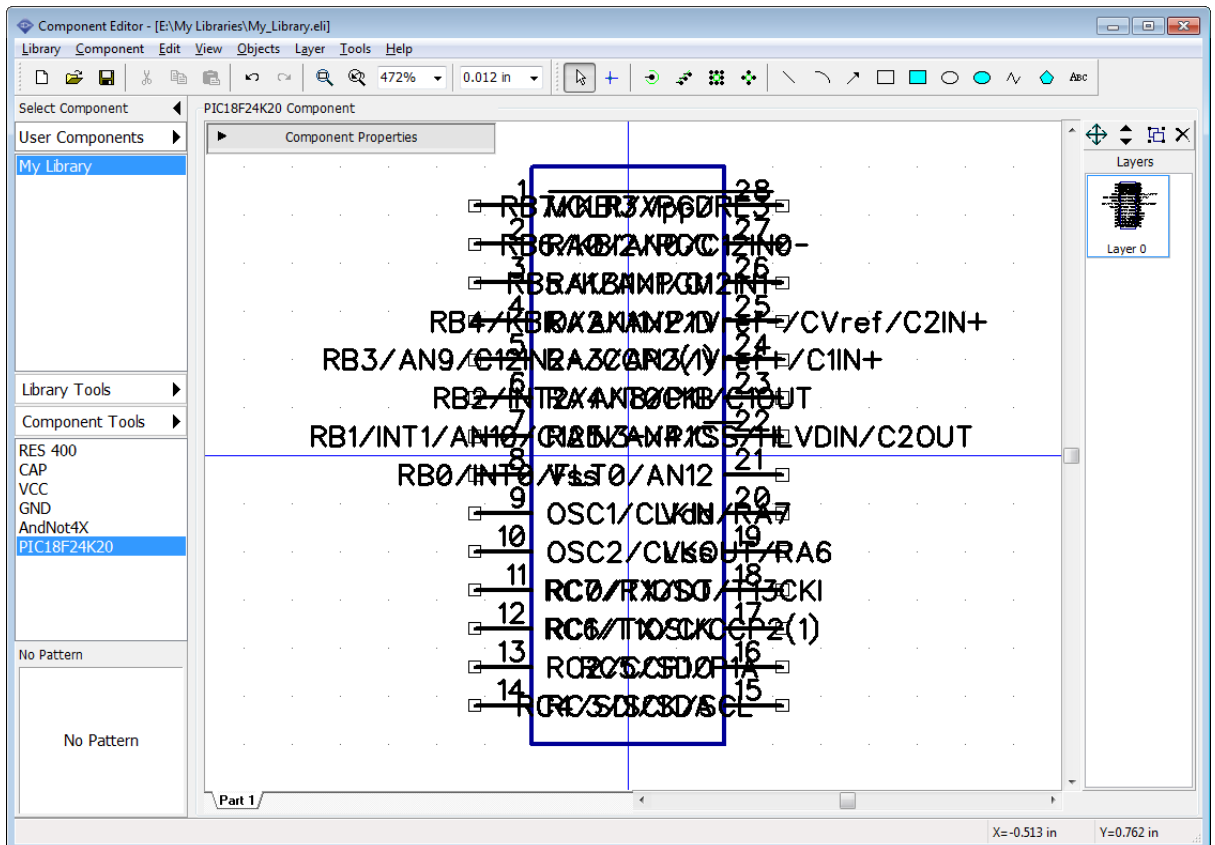

On the Component Properties panel change width to 1.9 inches and height to 2 inches. Pin names still overlay a bit, but we will regroup pins which will probably fix this. We made an IC a bit bigger because it will make it easier to do the pin regrouping. Change grid to 0.1 inch and place pins by this grid (select all pins, right-click, and select **Snap to Grid** from the main menu).

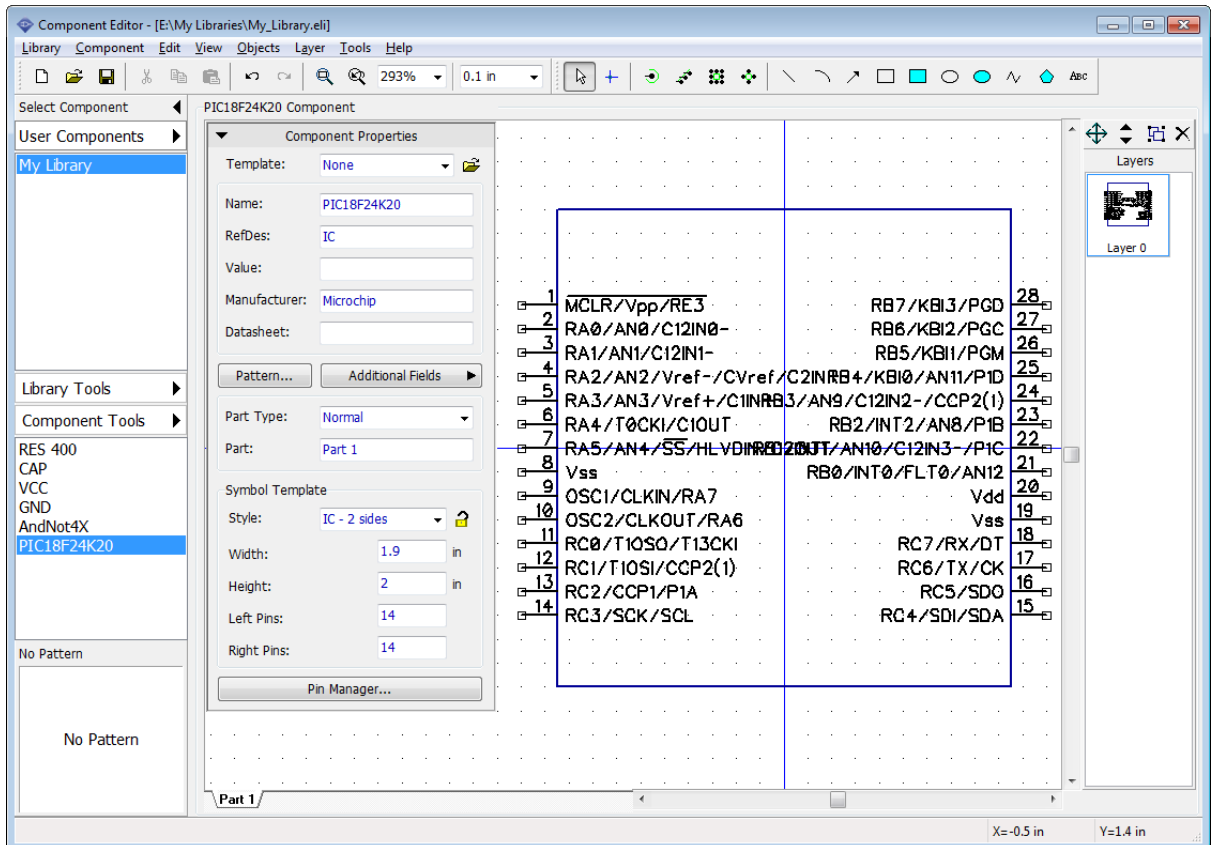

### Make buses (Group pins)

We need to group pins logically. First, we will make the busses – select "Component \ Make Buses from Pins" from the main menu. This feature allows the user to extract busses based on the pin names and group pins by busses. In the pop-up dialog box, you can define possible bus dividers. By default, only "/" is selected and it is OK for the current component, however, some manufacturers use different dividers.

Press **Extract** button and you will see available busses and number of pins for each of them. Select RA, RB, and RC busses using *Ctrl* key. Change Bus to Bus spacing to 1.3 inches, because pin names are quite long.

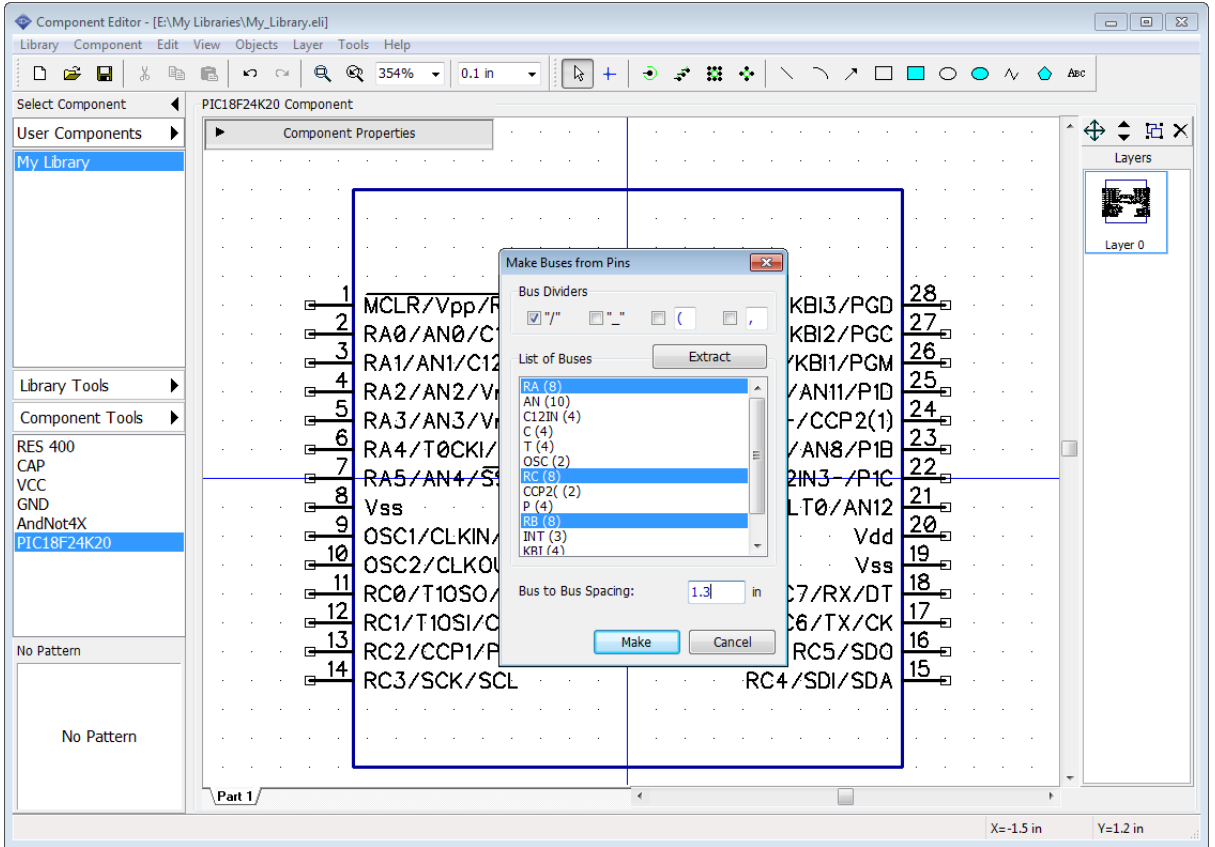

Press **Make** button to make the buses and close the dialog box. DipTrace sorts wires by buses to the left from the IC symbol.

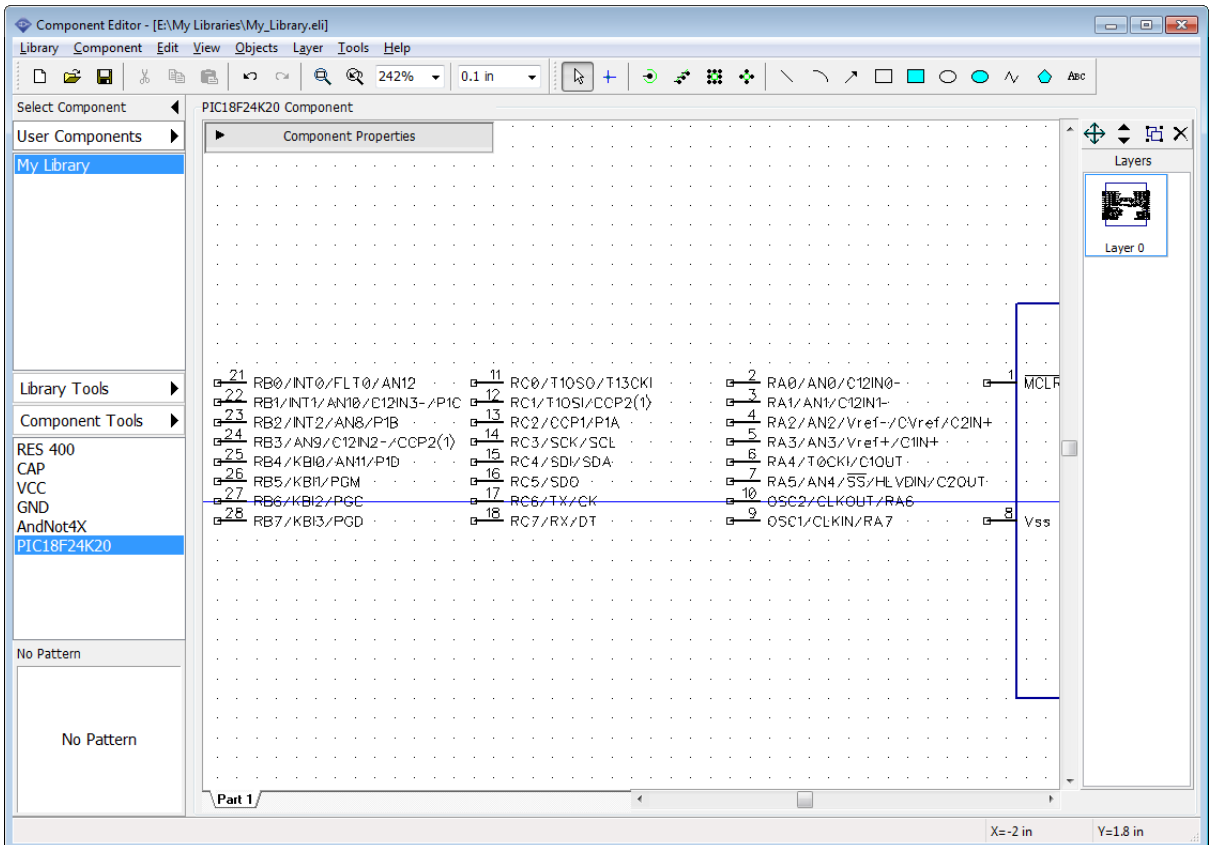

There are some pins that do not belong to selected buses (4 pins that left on the symbol). Select them, use *Ctrl* and box selection, then move pins away from the symbol, for example, to the bottom, because we need to place the busses first.

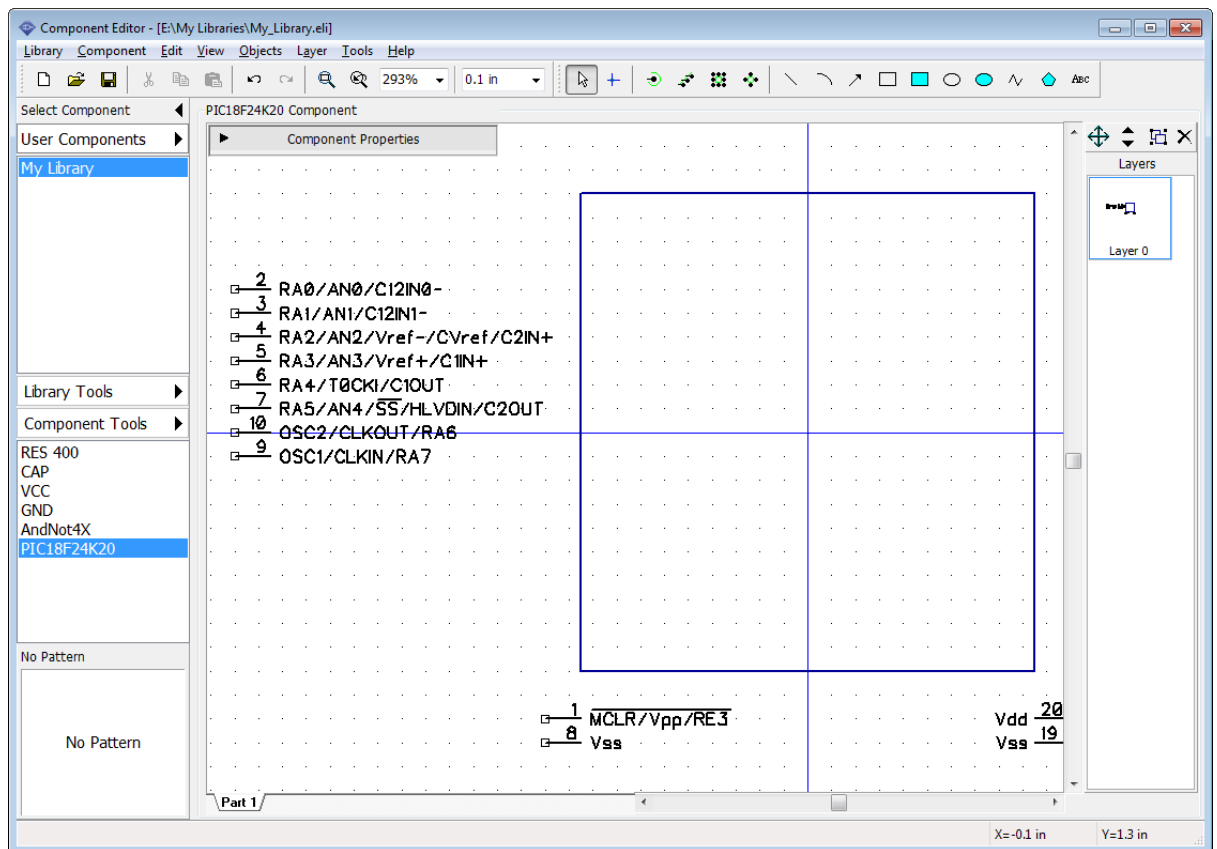

Place buses to the IC rectangle like in the picture below. Use box selection to select a bus, then drag it. Press *Shift+R* to rotate the bus and *Shift+F* to flip pins, or select these commands from the pin submenu (right-click on one of bus pins). Move the rest of pins to the IC rectangle (press *R* to rotate selected object/pin).

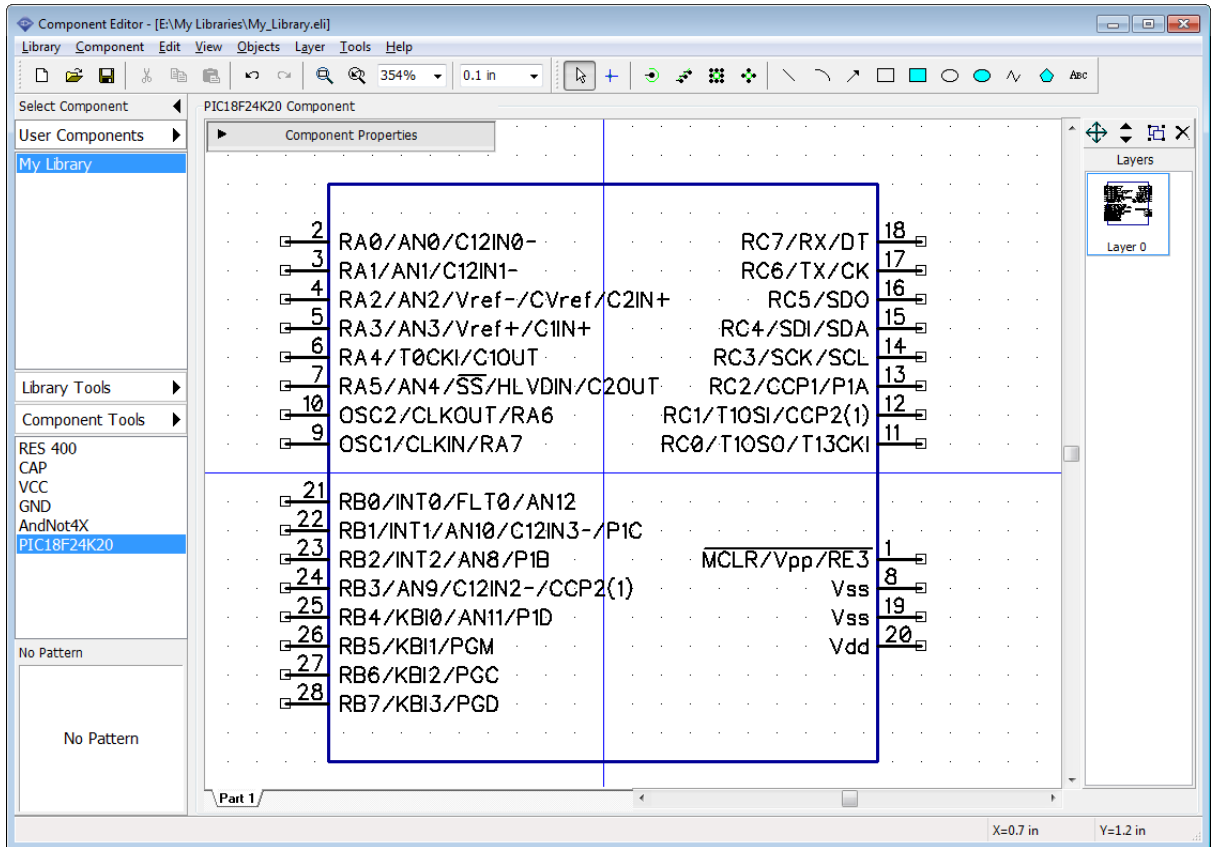

Sometimes you need to place pins by electric type, select "View \ Pin Colors by EType" from the main menu and the software assigns different colors for pins of different electric types.

Press  button on the **Component Properties** panel to lock properties.

The final step is attaching SOIC-28 pattern to the component. Press the **Pattern** button on the **Component Properties** panel and select SOIC-28 pattern from My library (we've created it [before](#)<sup>114</sup>). Select User Patterns library group, then select My Library (Patterns) and SOIC-28 from the list below. All pin names and pin numbers are already there. You can check pin to pad connections in the table. We don't need to change anything. Just press **OK**.



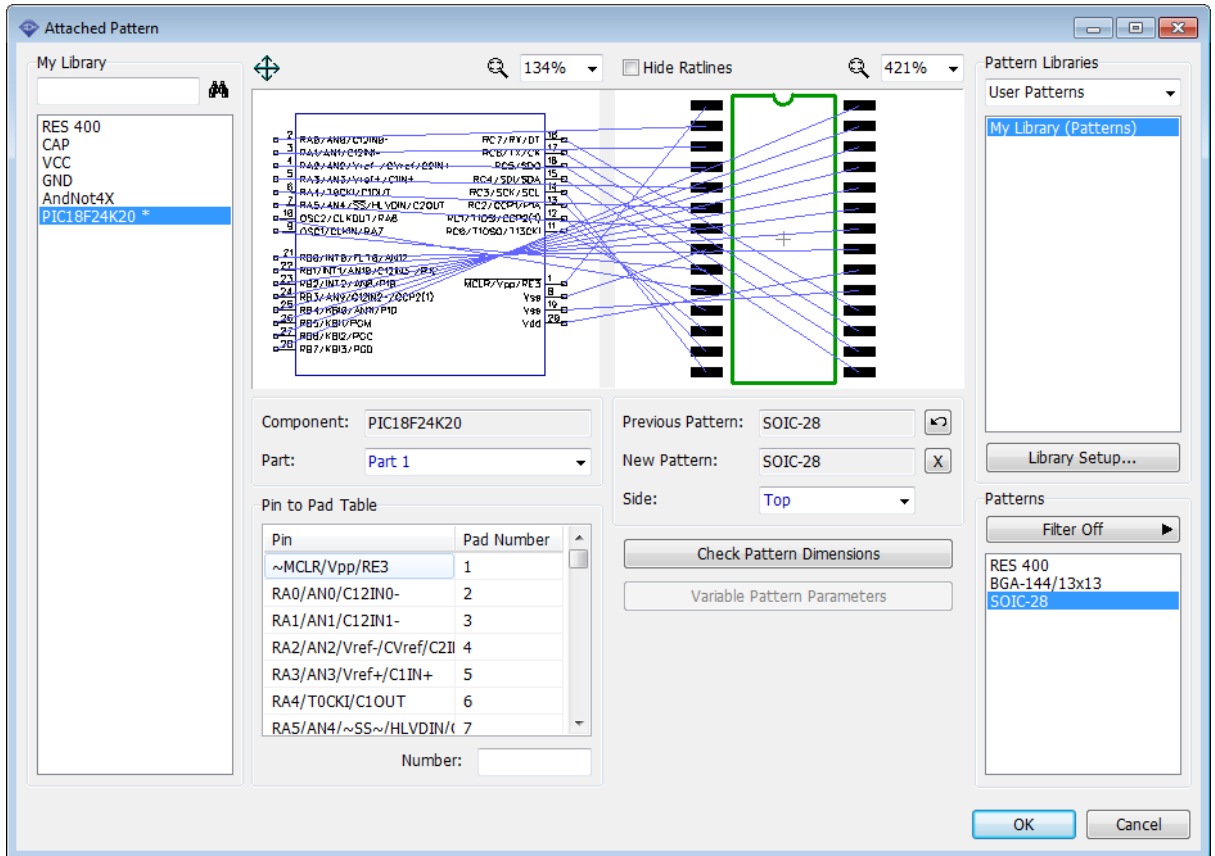

PIC18F24K20 component is ready! Save the library.

### 4.2.8 SPICE settings

With DipTrace you can export schematics into LT Spice to simulate it and see how the circuit works. We will review the simulation step later, for now, we need to define correct SPICE settings for the component, otherwise, the Spice simulation for this component will not work. Now we will specify that our CAP component is a capacitor with some value, so it will work in the SPICE netlist. Select CAP on the **Library Manager**, then select "Component \ Spice Settings" from the main menu. Set: **Model Type: Capacitor**, then double click in the **Parameters** table in the **Value** cell (the value reads "1uF" text) and enter a new value – "23 μF" (DipTrace supports Unicode characters). Press *Enter* or just move focus to another field.

In the **Template** field, you can see how this part looks in the SPICE netlist language. In our case, pin-to-signal map is correct, however, if you need to edit it, enter signal names into the table on the left side of the Spice Settings dialog box. The list of available signals is right below that table.

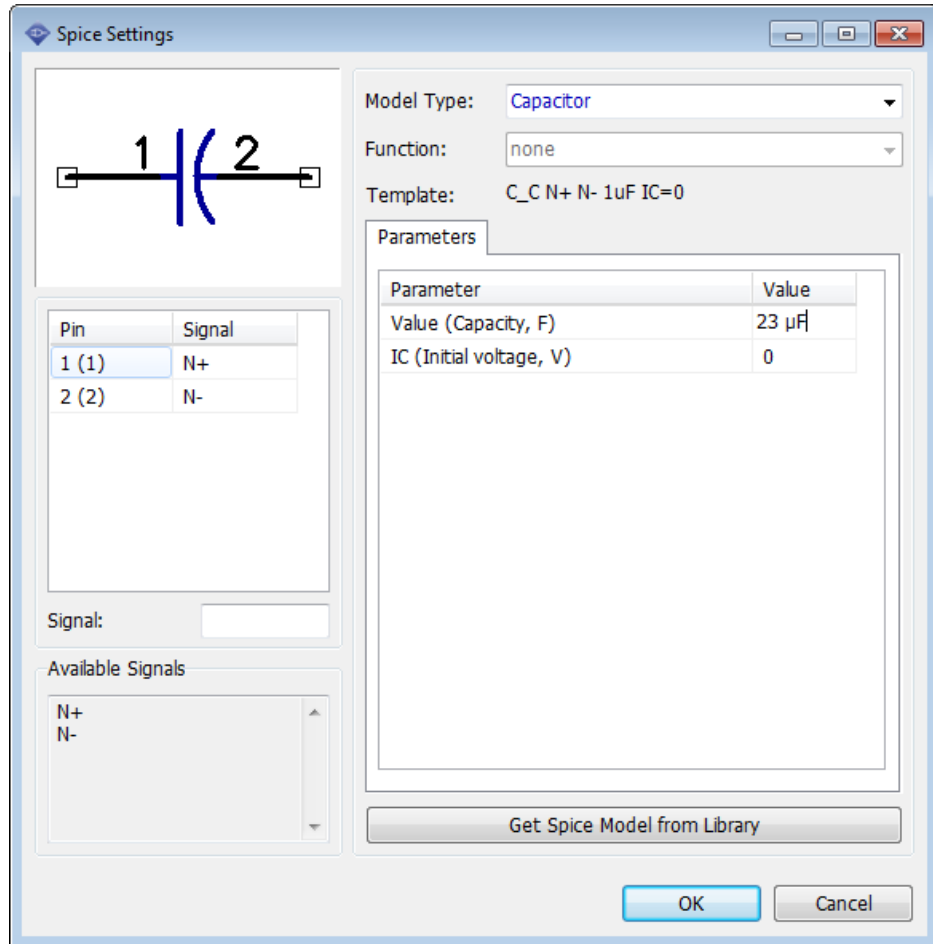

Capacitor is a very simple component, we don't need specific text file model to let the simulation software know how this component works (model type and capacity is just fine). However, for transistors, you can load models from external files (usually SPICE models are available on the manufacturers' websites) or enter model text manually if you know how to do that (see SPICE Language documentation for details). Also, there is a **SubSkt Model Type**, which allows the user to enter/load model of almost any part as a program.

Press **Get Spice Model from Library** button to load existing Spice settings from another DipTrace component.

Notice that this dialog box is also available in the Schematic Capture, you can define Spice settings after completing or while drawing the schematic.

Library design is ready. Click **OK** to apply changes and close the Spice settings. Save the library file.

#### 4.2.9 Library verification

It is very important to verify library for the most common types of errors. We've investigated the work of our library designers and added an automatic error verification to the Component Editor.

In the Component Editor select "Library \ Check "My Library" Library" from the main menu. In this dialog box, you can see the total number of components/parts/pins in your library and all possible errors.

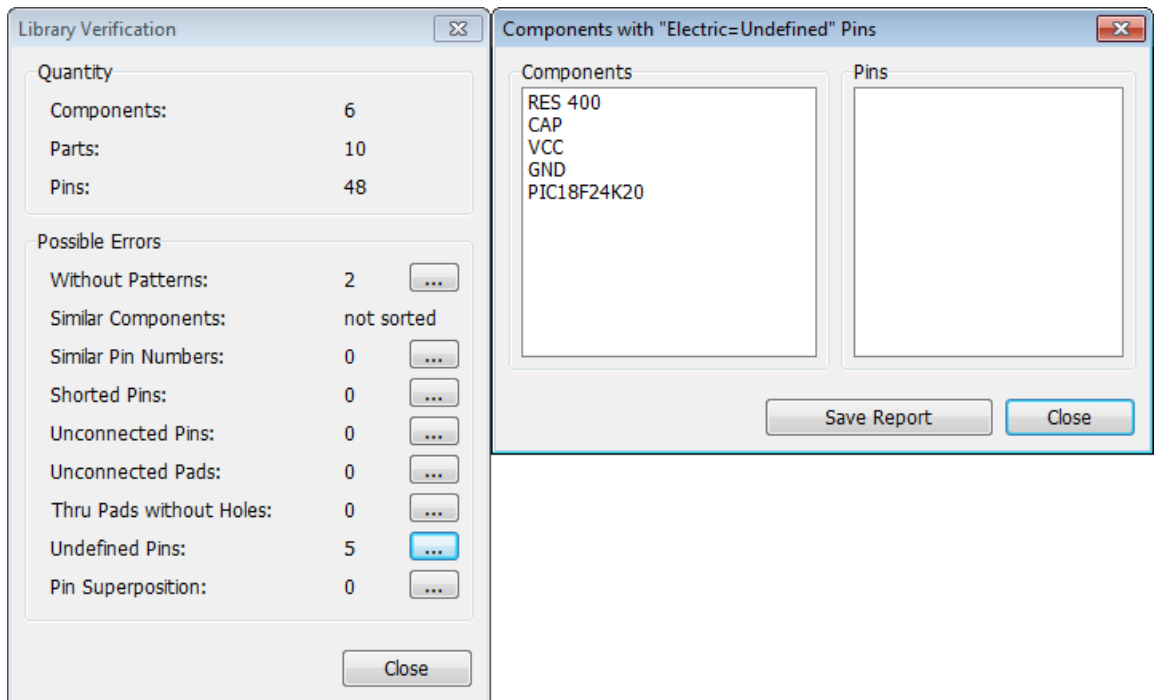

The following errors can be found automatically:

1. Components without patterns – search components without patterns. Keep in mind that some components may have only schematic symbol intentionally.
2. Similar components – search components with similar names. Notice that library should be sorted ("Library \ Sort Components in <current library>" from the main menu) to enable correct verification.
3. Similar pin numbers – two or more pins have similar numbers (connected to the same pad). This is probably a mistake in the component, please press the ... button and check pin numbers for a listed component.
4. Shorted pins – pins are shorted by internal pad-to-pad connections.
5. Unconnected pins – pins do not have the corresponding pattern pads. It's not always an error.
6. Unconnected pads – some pads of the pattern are not used (no corresponding pins). It is not always an error.
7. Through pads without holes – verifies components for the through pads without a hole. In the majority of cases this is a mistake in SMD pattern, please check if pads do really have the surface type selected.
8. Undefined pins – some pins have "Undefined" electric property.
9. Pin superposition ? some pins superimpose on the symbol, in the majority of cases this is a mistake made while placing the pins.

To see details (list of components and pins) press  button next to the corresponding mistake. You can save the list of errors as a text file.

Save changes and close the Component Editor.

## 4.2.10 Placing parts

### Schematic

Open the Schematic module, i.e. go to "Start \ All Programs \ DipTrace \ Schematic" in the Windows OS or use the DipTrace Launcher if working on MacOS. Select **My Library** from the **User Libraries** library group. Place a couple of resistors and capacitors to the design area. Just left-click on the component on the **Place Component** panel and left-click on the design area. If the origin is shown, press *F1* to hide it. Usually, you don't need the origin point for designing schematic.

Notice that you can place components using "Objects \ Place Component" dialog box or with the  button on the Objects toolbar.

Notice that colors of components, selections, etc., depend on the color template and user preferences.

### Multi-part component placement

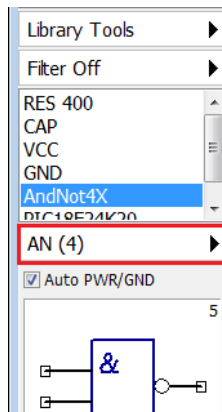

Select multipart component (ANdNot4X). DipTrace always shows that current component is multi-part or a net port in the symbol preview field on the Place Component panel (<the number of parts> or "Net Port" text). We have created AndNot 4X with four similar parts and a power part. You can place all parts as a single item or each part separately,

use the  button. Switch to AN(4) to place each component part one-by-one or PWR to place only the power part. If **Auto PWR/GND** item is checked, component's power part automatically appears on the design area when you place the first logic part of the component.

Select **AN(4)**, leave **Auto PWR/GND** checked, and place **AndNot4X** component part by part. The DipTrace automatically selects the next part from the part group and places the power symbol for the component.

Notice that program will automatically switch to the next part when all parts had been placed. Make sure you place parts only with RefDes from 1.1 to 1.4, like in the picture below.

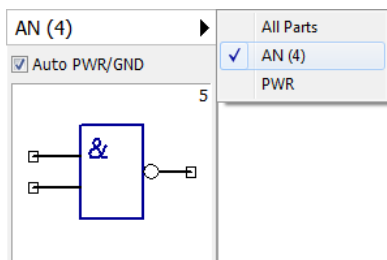
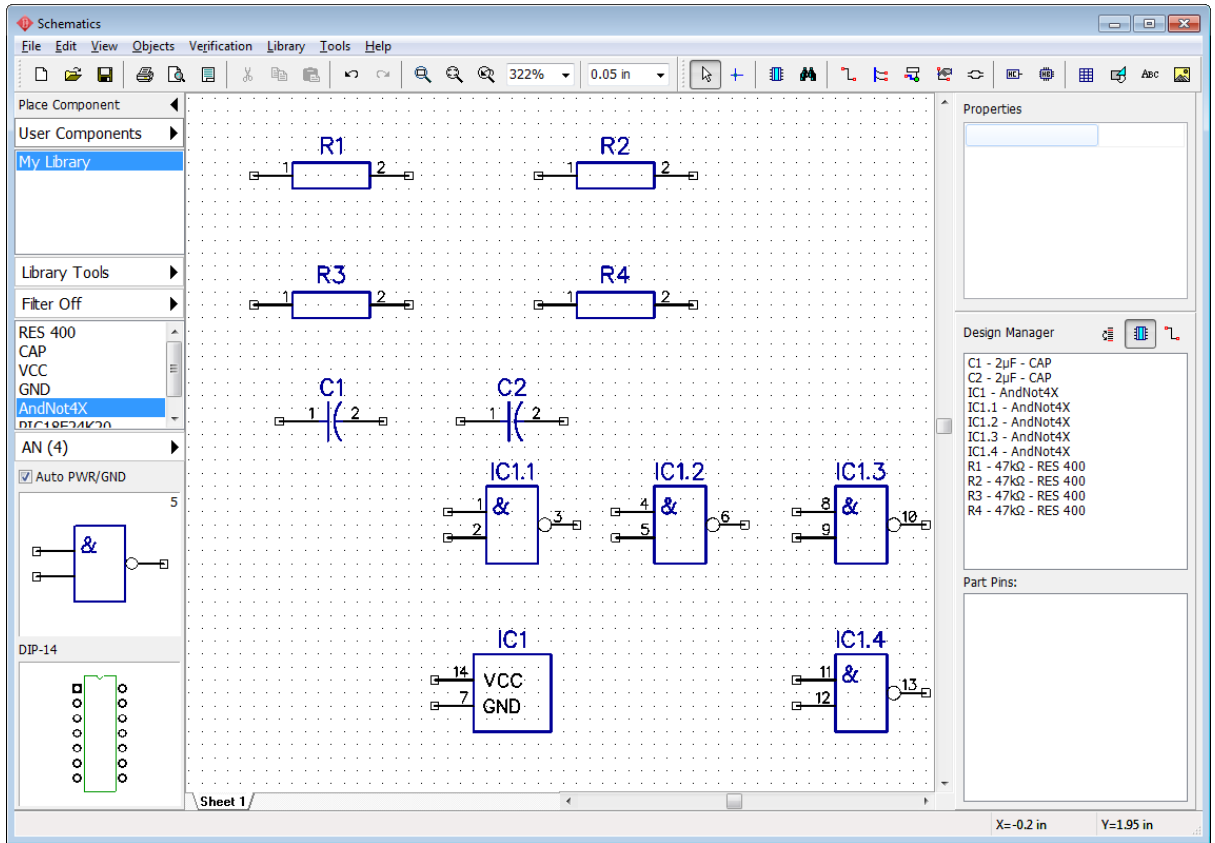

As you can see the similar parts of the multipart component are already grouped inside the part selection drop-down list. Select "View \ Group Similar Parts" from the main menu to ungroup parts. If this item is checked, all logic parts of the component (AN(4) in this case) will be grouped inside the **All Parts** pop-up menu. If unchecked, you will be able to select and place each AN part separately.

### Connection via net ports

Make sure that you have two complete AndNot components on the design area (IC1 and IC2) with two power symbols. Now we'll try to use the net ports. Select VCC and GND net port symbols from the library, and place two of each to the schematic. Connect pins like in the picture below.

*Notice that two wires connected to the same pins of the same-type net port are connected to a single net automatically.*

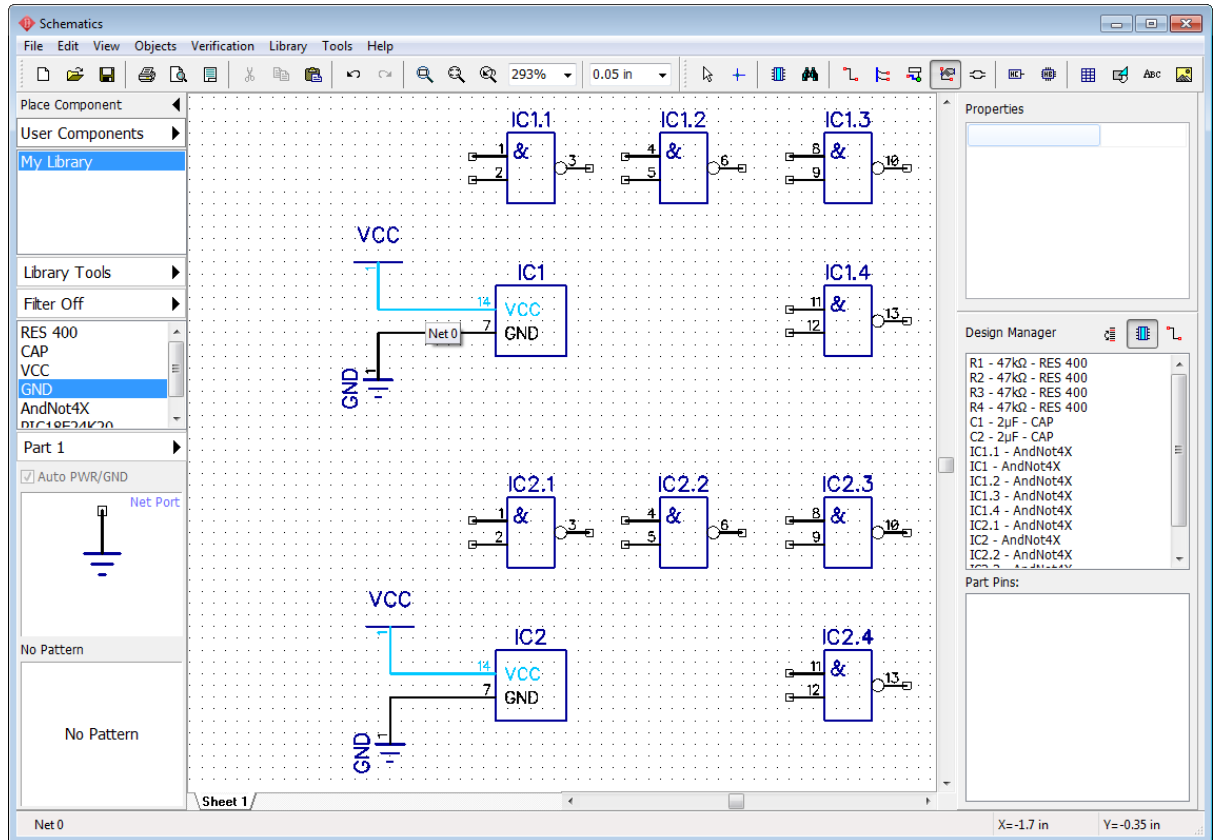

To rename net which connects VCC pins, right-click on the wire, and select the first item from the submenu or right-click on the pin, and select the Net Name.

Notice that you can change part names directly in Schematic (on the **Component Properties** dialog box).

Schematic allows the user to:

- 1) Connect pins to nets without wires (right-click on the pin, select **Add to Net**, then select net, check **Connect without wire**, and press **OK**);
- 2) Merge nets by name (check **Connect Nets by Name** check box in the **Net Properties** dialog box);
- 3) Connect pins to the net with similar name automatically (check **Connect Net to Pins by Name** checkbox in the **Net Properties** dialog box). The last method is the fastest way to connect VCC, GND (if you plan to hide power nets and parts), CLK, etc. More information [later](#)<sup>[163]</sup> in this tutorial. Close the Schematic. Do not save the changes.

## PCB Layout

Open DipTrace PCB Layout module, i.e., go to "Start \ All Programs \ DipTrace \ PCB Layout" on Windows or use the DipTrace Launcher on MacOS.

As you already know, correct component always includes at least a schematic symbol (for Schematic) and attached pattern (for PCB Layout). Schematic works only with symbols, while PCB Layout allows to select component libraries and place component's patterns on the board. If you have selected component library and there are components without attached patterns, you can not place them on the board. Notice that there is the **Patterns** library group for convenience, which allows the user to place patterns as separate entities (no

*schematic symbols attached).*

Select **User Patterns** library group and **My Libraries (Patterns)** library. You will see that all three patterns that we have created during the lessons of this tutorial are available here. Now select **My Library** from the **User Components** library group. As you remember, we did not attach patterns only to net ports, therefore we can not place them on the circuit board in the PCB Layout. All other components work just fine because they all have attached patterns.

Place all components of the library to the design area, excluding the VCC and GND (select component on the **Place Component** panel and left-click on the design area to place it), then return to **My Library (Patterns)** from the **User Patterns** library group and place **BGA-144/13x13** pattern, which we did not attach to any of the symbols, therefore it is not available in the component library.

Change common marking settings to show RefDes and Name ("View \ Component Markings \ Main \ RefDes" and "View \ Component Markings \ Additional \ Name"). For individual customizations, right-click on the component, select Properties, select the Markings tab. You might need to justify texts in the "View \ Component Markings \ Main (Additional) \ Justify \ Auto" main menu item.

Select **Bottom Side** in the drop-down list on the Objects toolbar if you want to place components on the opposite side of the board. For existing components, you can change side with the right-click submenu. For example, the R3 resistor is on the bottom side (see the picture below).

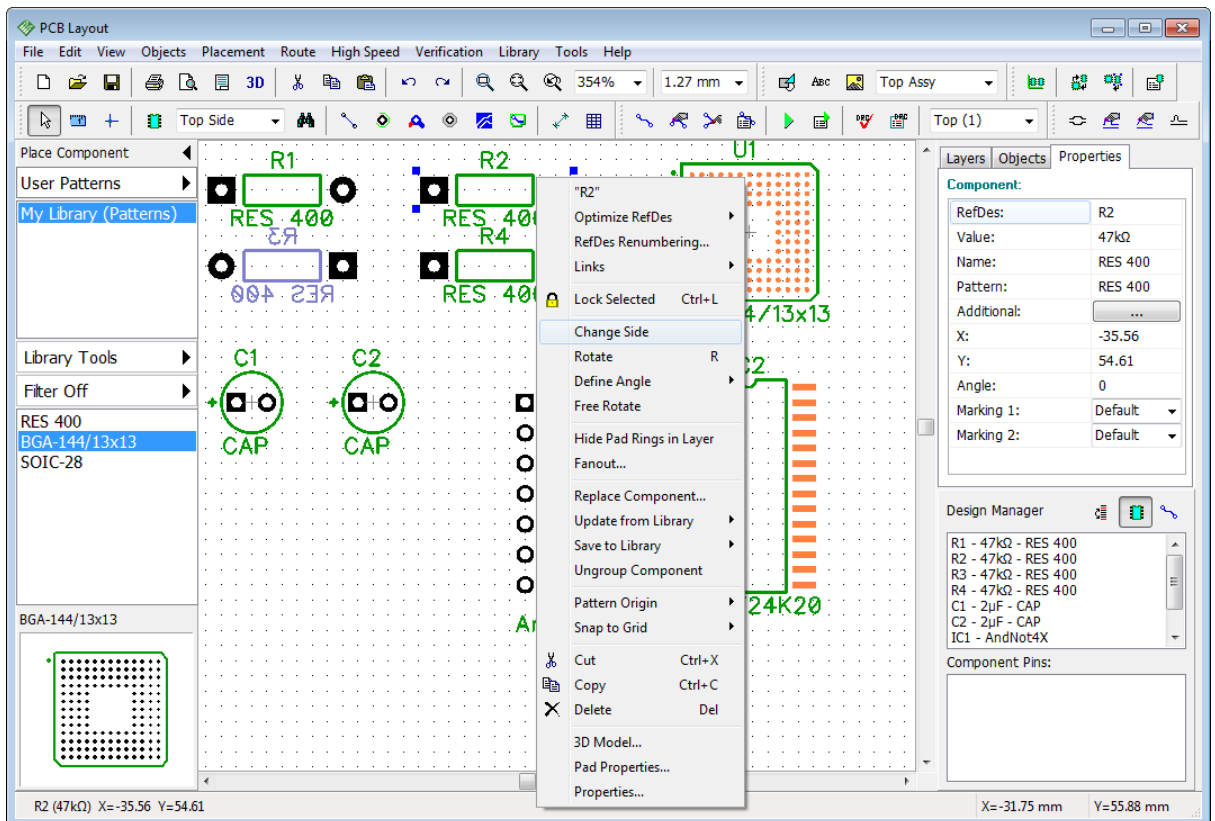

You can change pad properties for the separate pad or entire component's pattern directly in the PCB Layout. Let's change one of the resistor pads. Hover over the pad you want to change (it should be highlighted), right-click it, and select **Pad Properties** from the submenu. In the pop-up dialog box uncheck the **Use Pattern's Pad Properties** checkbox for custom

pad settings or press **Pattern's Pad Properties** button to change default pad settings for the pattern. To edit pattern pad properties, right-click on the pattern (not the pad) and select **Pad Properties** from the submenu.

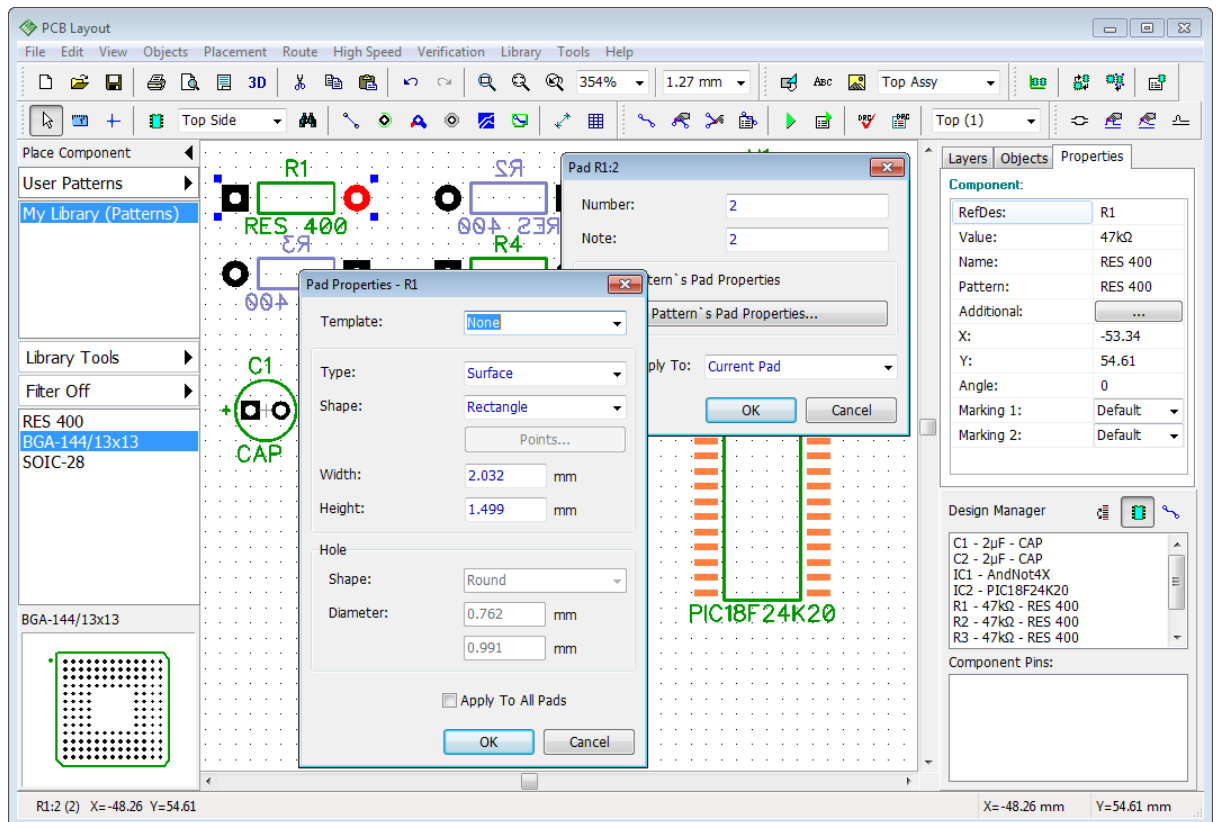

*Notice that if pattern's origin is different from the pattern's center position, the software will show it while placing that pattern.*

You can show/hide the pattern origin for all selected components: right-click one of them, and select **Pattern Origin** from the submenu. Try to rotate different components and you will see that the pattern origin is actually the center of rotation. When hovering over the pattern you will see the coordinates of the pattern, which are actually the coordinates of the pattern's origin.

## Part V: Other features and tools

This part of the tutorial includes the description of important DipTrace features not reviewed above. We consider that the reader already knows how to accomplish basic tasks in DipTrace. Therefore, we can move on to more complex stuff.

### 5.1 Connecting

#### 5.1.1 Buses and bus connectors

Now we learn how to use buses and connect sheets with bus connectors in the Schematic. You can work with the circuit from the previous subsection of this tutorial or create a new schematic with random components for practicing.



## Create a bus

Select "Objects \ Circuit \ Place Bus" from the main menu or press  button on the Objects toolbar, then draw a bus line on the design area by defining its key points. Right-click, and select **Enter** to finish bus placement. Right-click on a free space to switch to the Default mode. Hover over some pin with the mouse, left-click it, and move the mouse pointer to the bus, and left-click again to create a wire.

In the pop-up dialog box, you can define a name of a new net or connect a wire to one of existing nets (which are already connected to that bus).

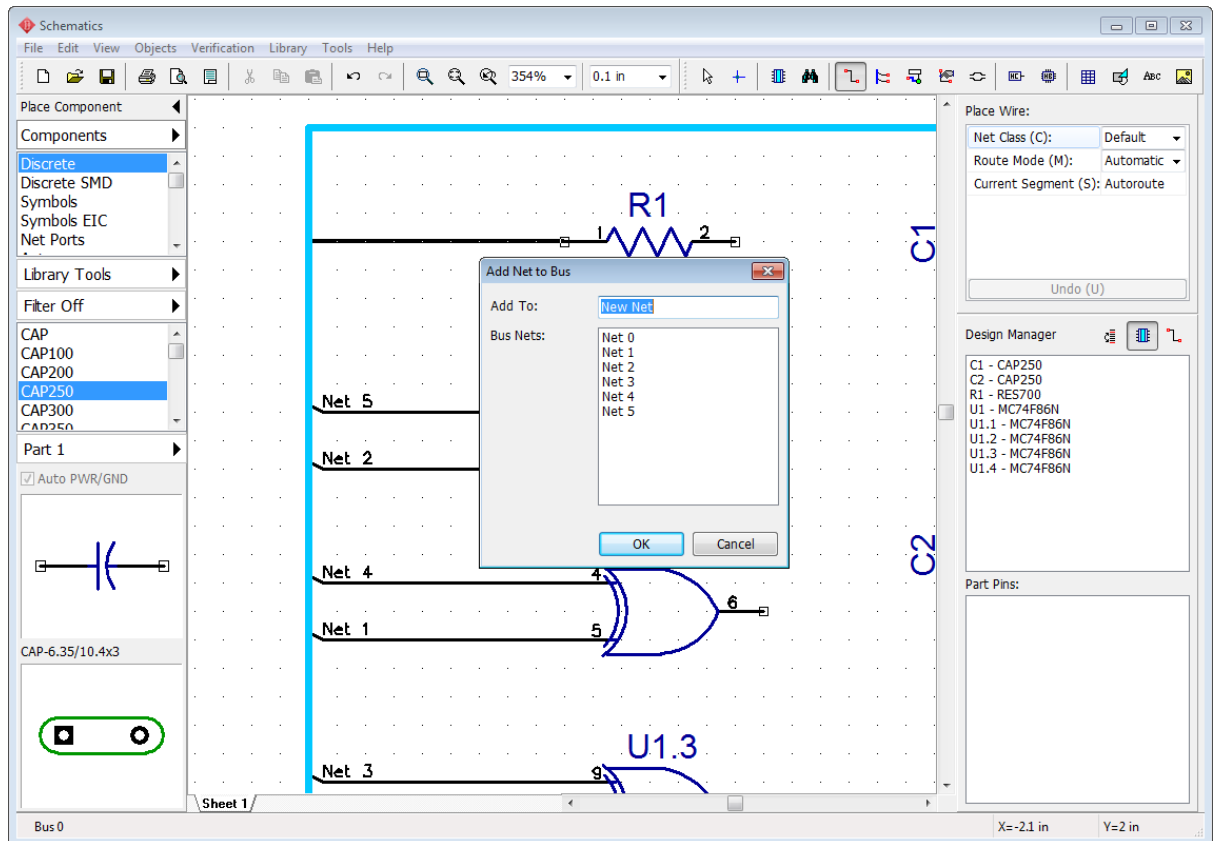

We did not connect the wire to existing net. This is why we have seven separate wires-nets (Net 0 – Net 6) not connected to each other via the bus. Fortunately, you can change the wire-to-bus connections at any given moment, just move the mouse cursor to the wire segment connected to the bus, right-click, and select **Bus Connection** from the submenu.

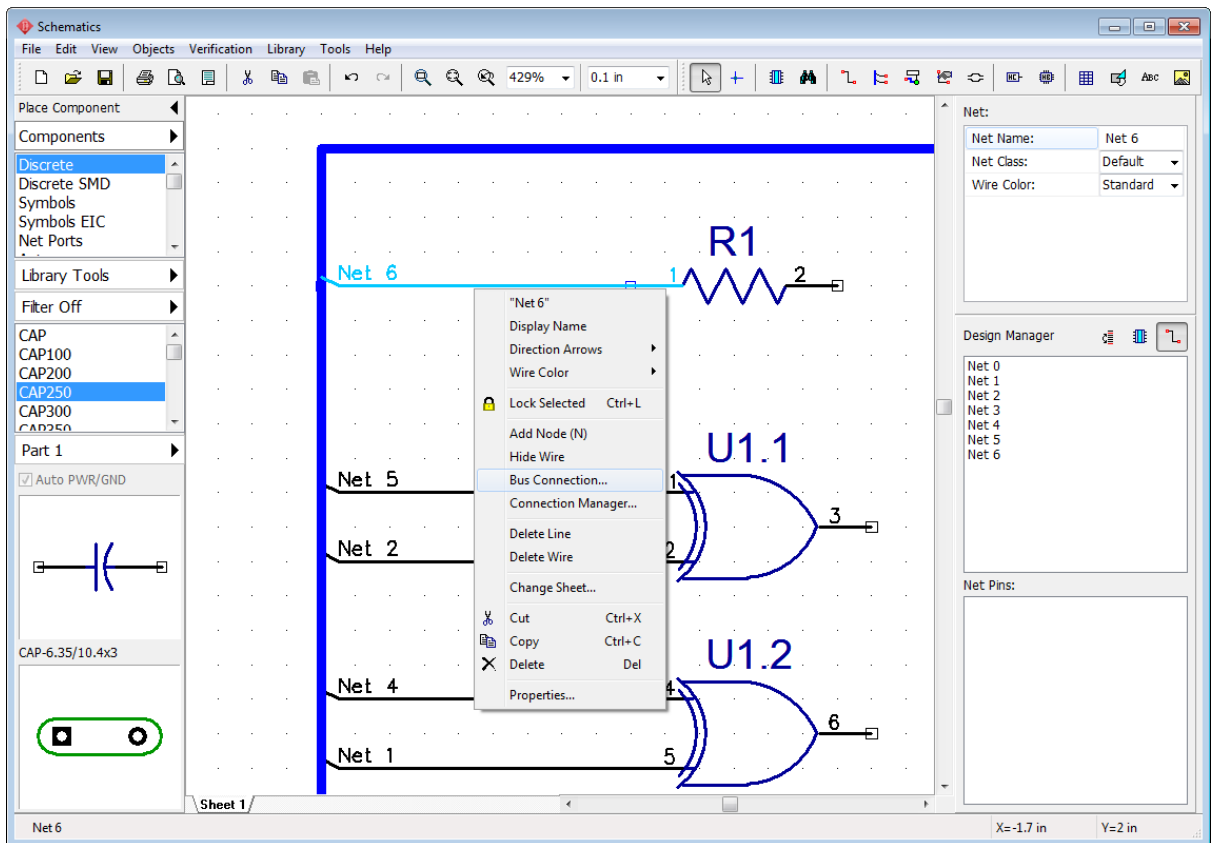

In the pop-up dialog box connect Net 6 to Net 2 (select Net 2 from the list of the bus wires). Now there is no Net 6 anymore. We have a single Net 2 connected via the bus.

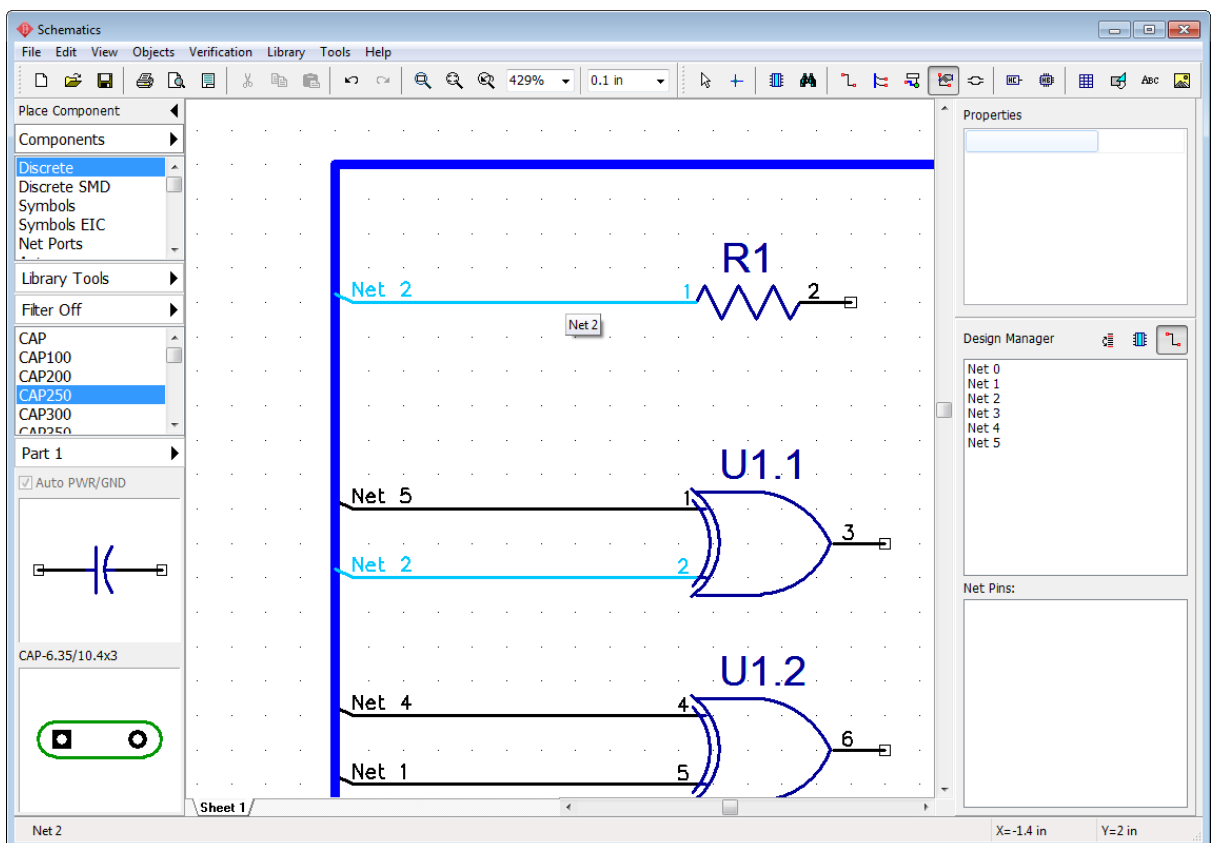

Add a new sheet to the schematic, select "Edit \ Add Sheet" from the main menu or press *Ctrl+Ins* hotkeys. You can see the list of sheets as tabs at the bottom-left corner of the design area. Select **Sheet 2**. [The multi-sheet and hierarchical structure](#)<sup>[214]</sup> is described later in the corresponding section of this tutorial.

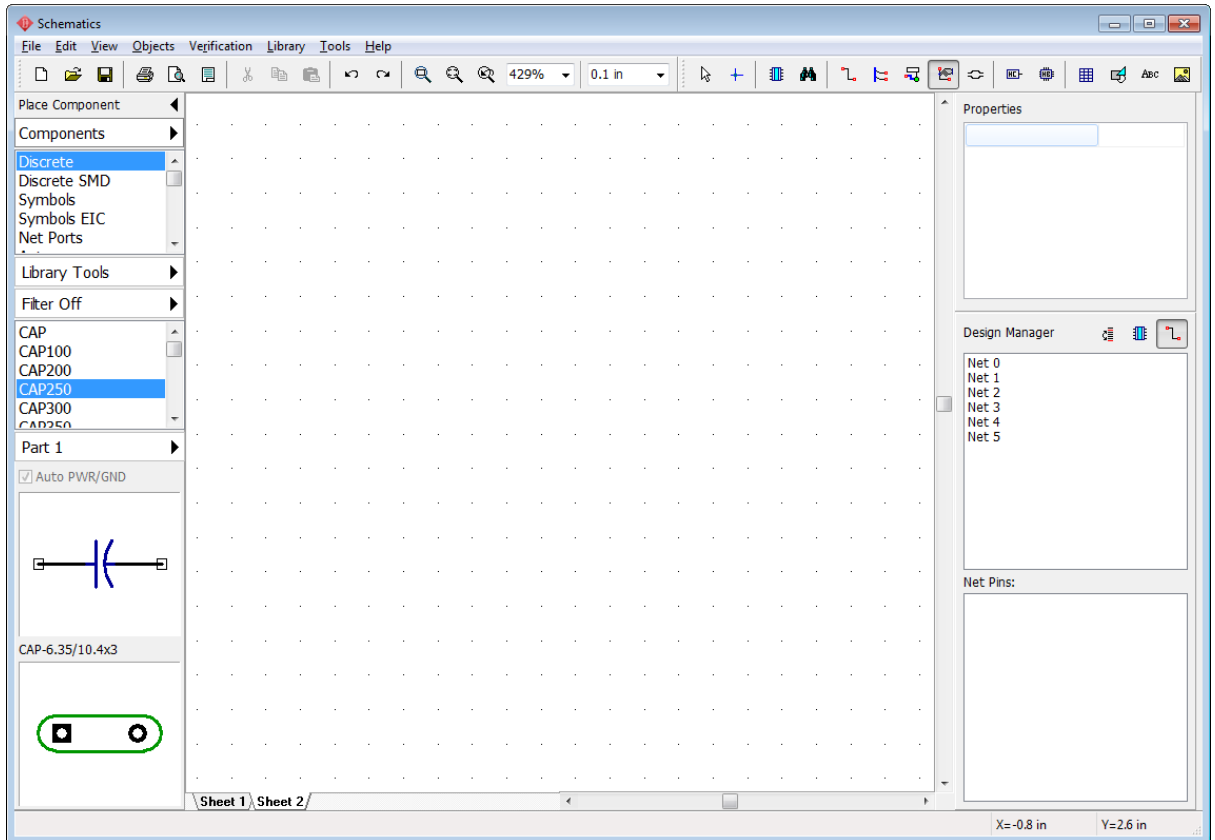

You can rename, move, delete, or insert new schematic sheets, right-click on the sheet in bottom-left of the design area and select appropriate action from the submenu.

### Bus connector

Press  button on the Objects toolbar and place a bus connector on the Sheet 2 (it should have "Port 0" name), then select Sheet 1, and place one more bus connector there (it will be "Port 1" automatically). Now connect the existing bus to the **Port 1** connector: select the bus tool, left-click on the bus and draw the line to the bus connector (blue circle in the center of the connector) and left-click it to finalize.

*Notice that bus connector glows **green** if the bus is properly connected to it, blue circle means that there is no connection.*

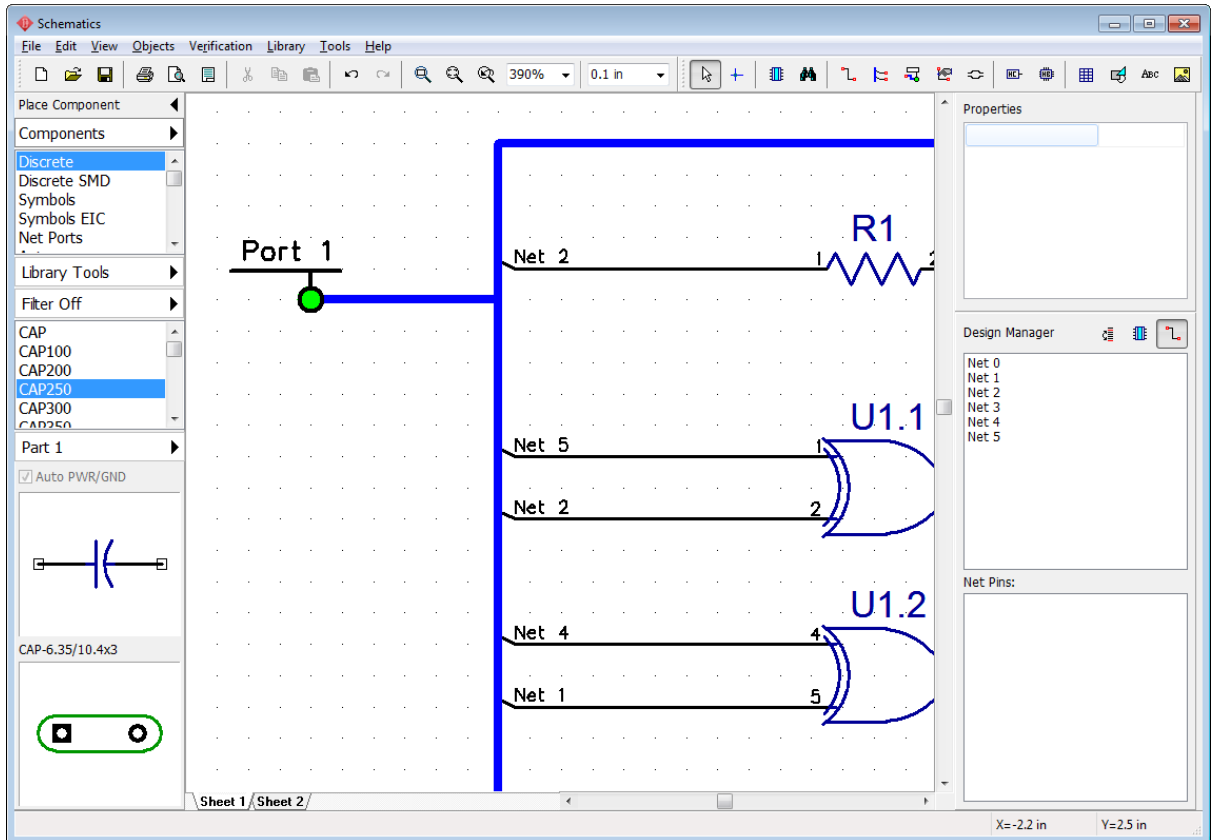

*Notice that two bus connectors on different sheets are still unconnected (they should have the same name in order to be connected).*

Rename Port 1, hover over it with the mouse cursor, right-click it, select the first item from the submenu, and rename bus connector to "Port 0" (as you remember we've placed "Port 0" on the Sheet 2). Press **OK**. You can see that the box has appeared around the port's name. This means that current bus connector is connected to another bus connector. In our case, the connector from the Sheet 1 is connected to the connector on the Sheet 2.

*Notice that designer can connect more than two bus connectors by defining the same names to all of them.*

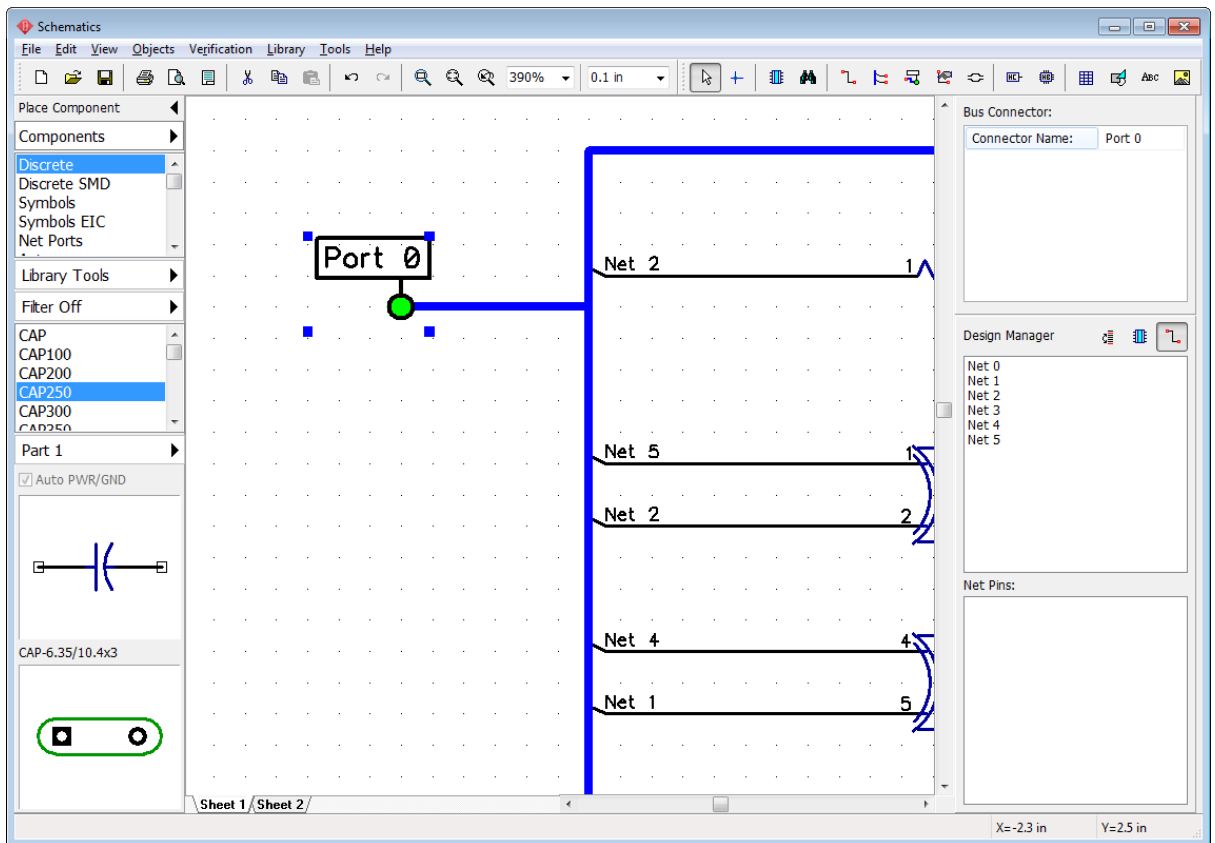

Select Sheet 2, and create a bus connected to the Port 0.

Notice that the name of the bus on this sheet is the same as on the first sheet, i.e. this is a common bus. Now you can place random electronic components on the second sheet (for example [AD1317](#) from [Analog Devices](#) library) and connect their pins to the nets on the first sheet via the bus.

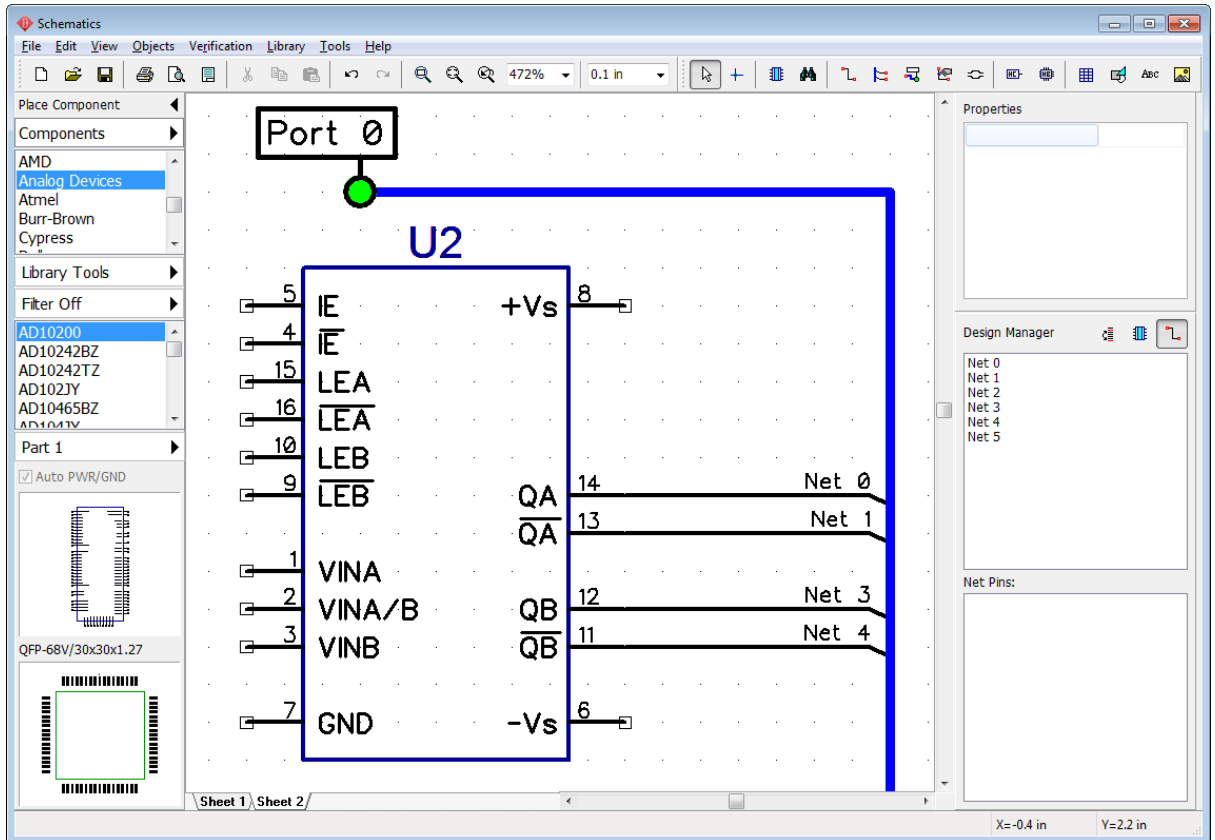

### 5.1.2 Net ports

We tried to use single-pin net ports [before](#)<sup>[152]</sup> in order to create VCC and GND connections. This is the most common application of such components in real-life, but sometimes multi-pin net port is a more comfortable design solution.

Make sure there are unconnected pins on the Sheet 2. Select the **Net Ports** library from the **Components** library group on the Place Component panel, find **Port 8** component, and place it on the design area.

Make connections from the component pins to the pins of the Port 8, then position one more Port 8 component to the Sheet 1, and connect it with some nets. Notice that net names connected to the same pins of Port 8 on Sheet 1 and Sheet 2 are the same, i.e. all wires connected to pin 1 of the Port 8 are connected to a single net, the same with other pins. You can connect or disconnect ports (i.e. change schematic structure) by renaming them.

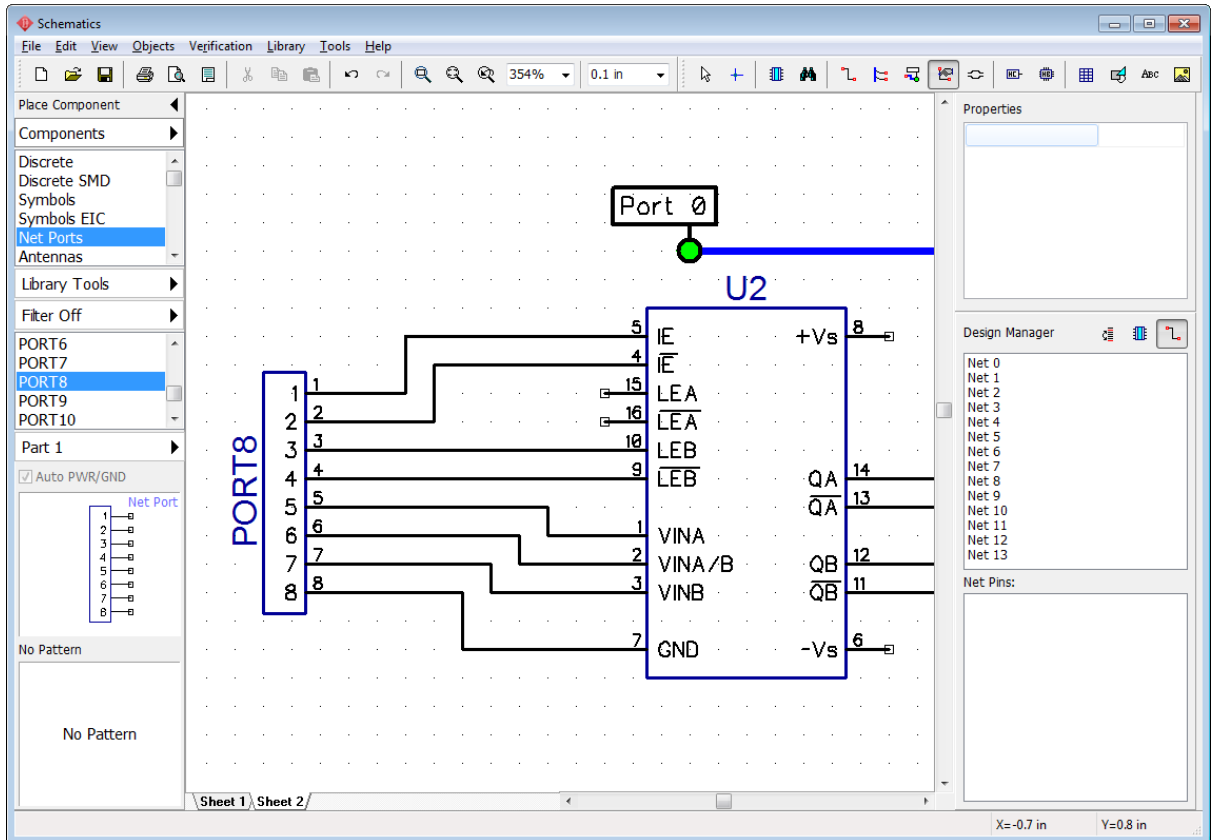

### 5.1.3 Connecting without wires

As you already know, DipTrace allows the user to connect pins visually (wires, buses) and logically (without wires, by name, with net ports).

#### Connecting pins without wires

You can connect pins logically without wires. In this case, pins do not depend on the sheet or part location.

Hover over selected unconnected pin with the mouse, right-click it, and select **Add to Net** from the submenu. In the pop-up dialog box select net from the drop-down list, and check **Connect without Wire** checkbox, then press **OK**. In the picture below you can see two pins connected without wires.

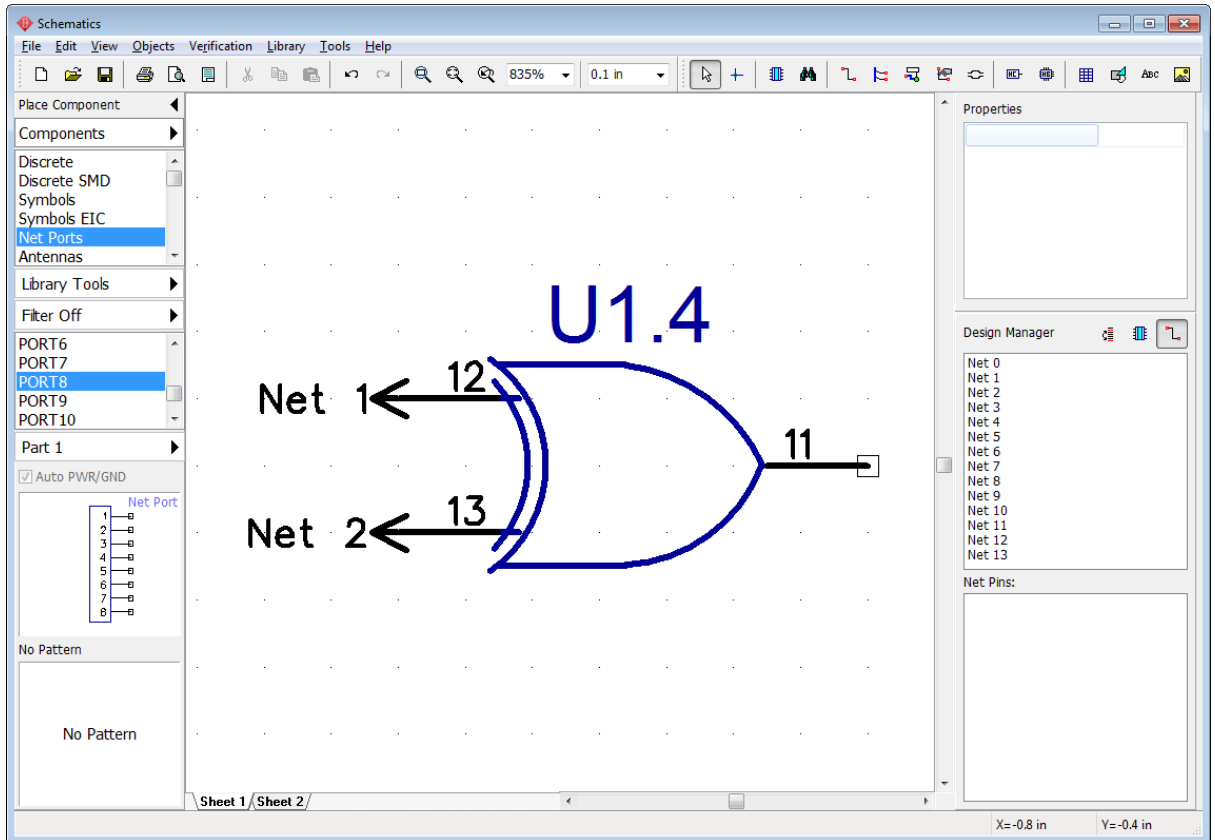

### Connecting pins by name

Now find a blank spot on the design area where we will try to connect pins to the net by name. Place a single GND symbol from the Net Ports library, and create a small wire from the GND's pin. Move the mouse a bit upwards, and press **Enter**, like in the picture below, to create a wire segment. Now right-click on the wire segment connected to the GND net port, and select **Properties** from the submenu.

In the **Net Properties** dialog box rename net to "GND," and check **Connect Net to Pins by Name** checkbox. Press **OK** to apply changes.

*DipTrace automatically connects all unconnected pins with the corresponding name to this net.*



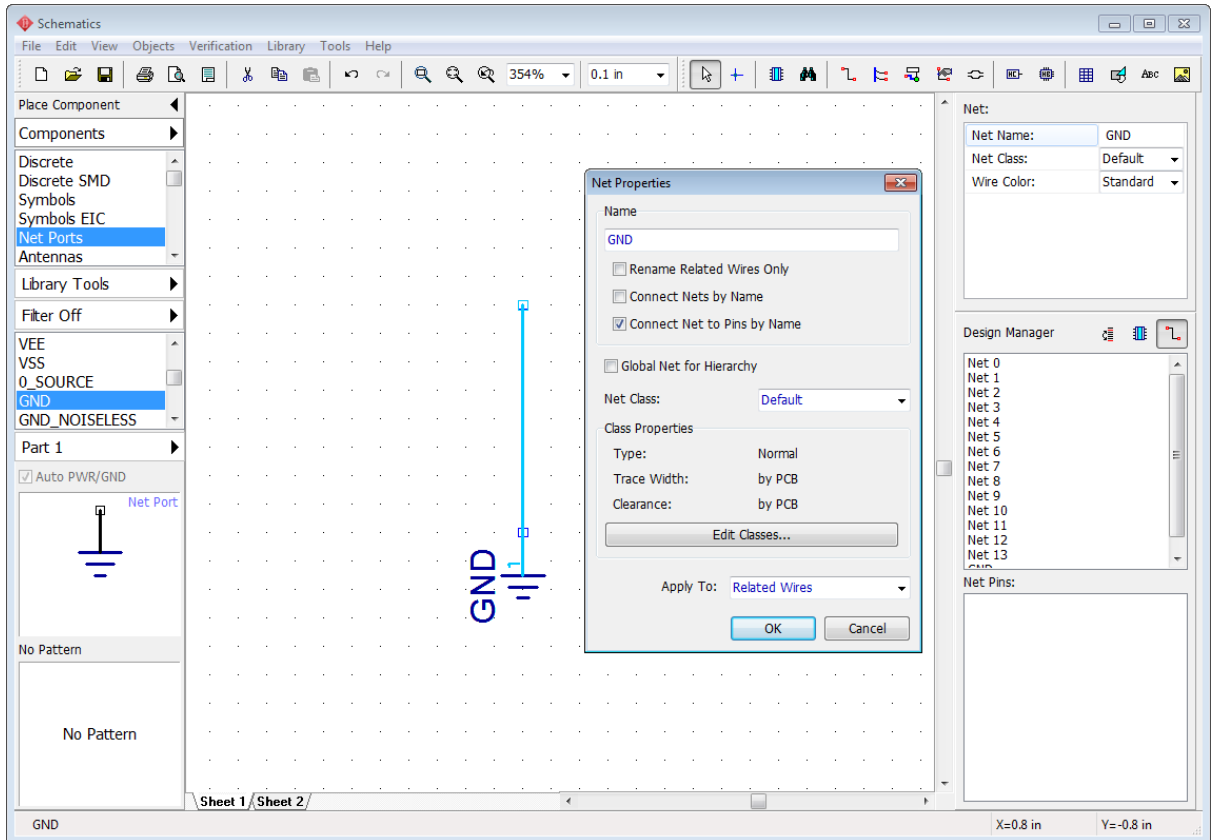

Select Analog Devices library, and find<sup>168</sup> AD1317KZ component (press **Filter Off** button, type "AD1317" into the name field and press **Apply Filters**). Place several AD1317 components on the design area or copy them if you already have one.

Notice that all GND pins of placed component are automatically connected to the GND net without wires due to active **Connect Net to Pins** option in the **Net Properties** dialog box. This feature is the easiest way to connect pins with the same names for the entire schematic. Usually applied to POWER, GND, CLK pins or even data buses.

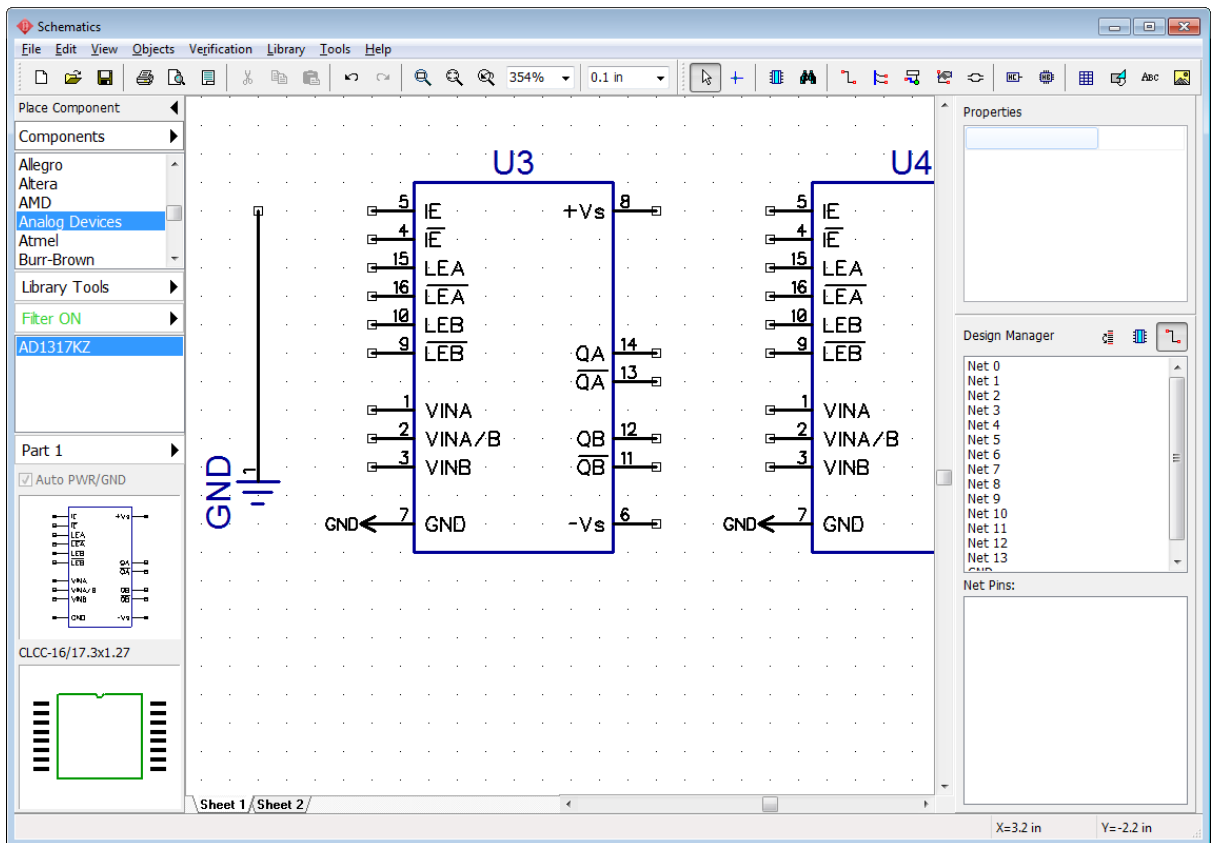

### Connect nets by name

DipTrace allows the user to connect nets on different sheets without net ports or buses. Remember the name of some net that you have on the first sheet (for example, Net 3), then go to Sheet 2, and right-click on the net you want to connect to Net 3. Then select **Properties** from the submenu, type in "Net 3", check **Connect Nets by Name** checkbox, and press **OK**.

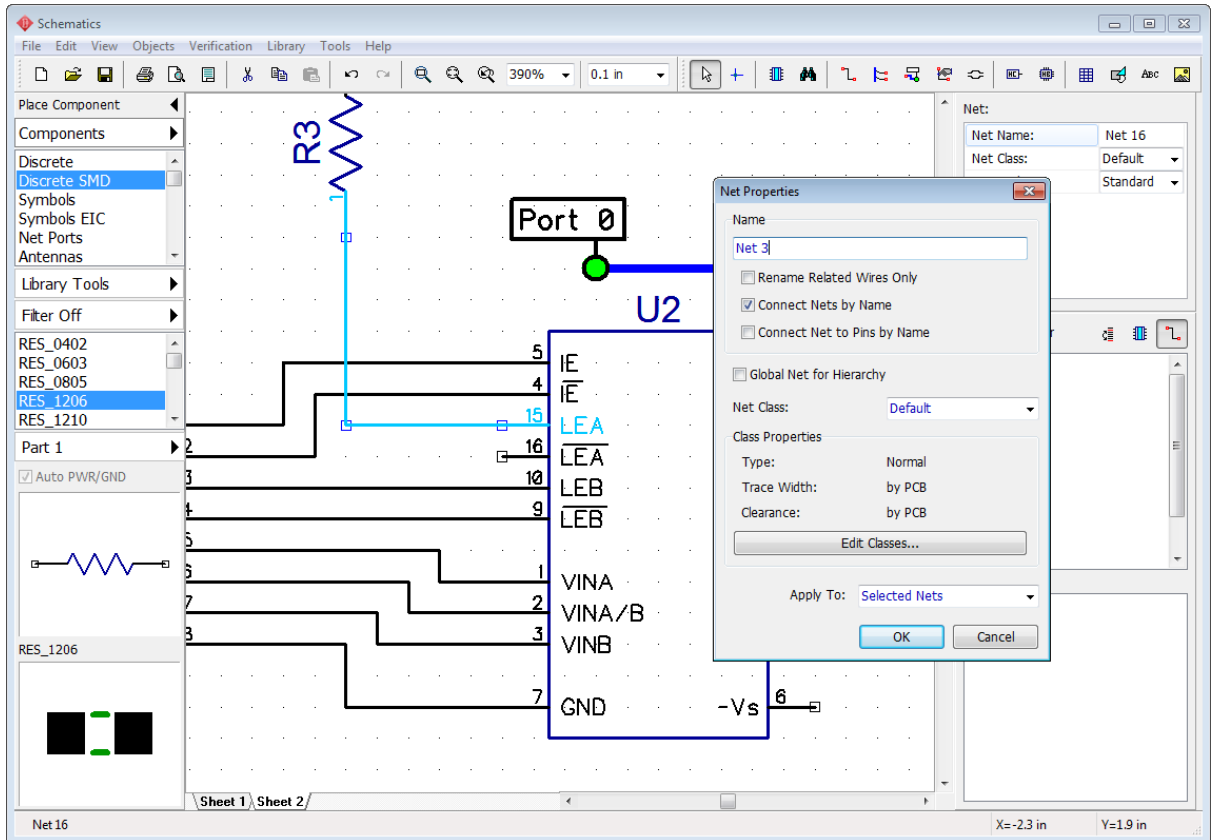



This feature works like a regular net renaming. When you enter the net name that already exists anywhere on the schematic, DipTrace asks if you want to connect these nets by name.

*Notice that you **can not** connect nets by name on different levels of hierarchy.*

For hierarchy, you can create **global nets**. We will learn how to use them later in the [Hierarchical Schematic](#)<sup>[214]</sup> topic of this tutorial.

#### 5.1.4 Connection Manager in Schematic and PCB Layout

Connection Manager is another DipTrace tool which allows the user to create/edit/delete connections in Schematic and PCB Layout. Select "Objects \ Connection Manager" from the main menu in Schematic or "Route \ Connection Manager" in the PCB Layout.

Open connection manager in Schematic. Select a net from the drop-down list, and you see all pins of selected net. You can easily add/delete pins to/from the net. To add new pins to the net, select a component and its pin with the corresponding drop-down lists, and press the **Add** button. Notice that only unconnected pins are available in these drop-down menus, so if you can not find a pin that you need, it is probably already connected to another net. Use the  button to create a new net, the  button to rename a current net, and  – to delete it.

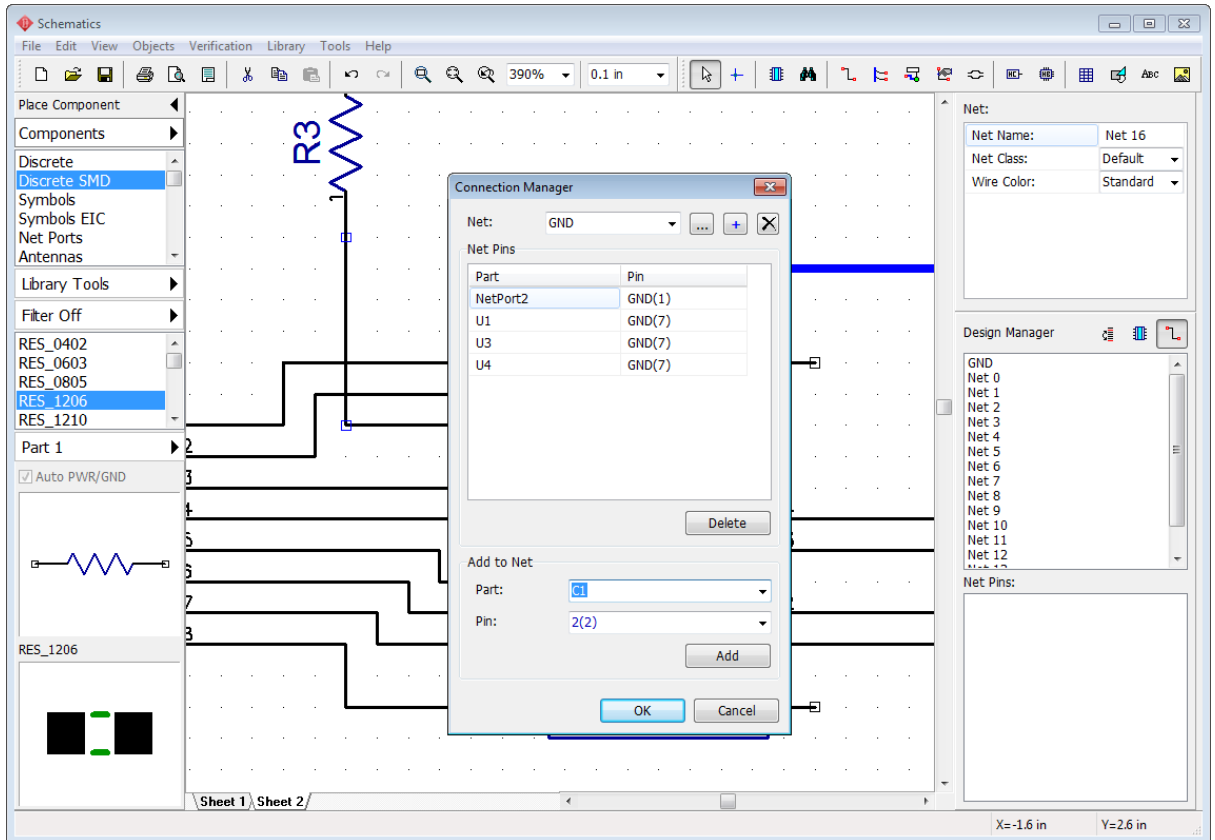

Press **OK** to apply changes and close the **Connection Manager** or press **Cancel** to close it and recover the old net structure.

## 5.2 How to find components in the libraries

DipTrace 3.1 includes 140,000+ components in the standard libraries, and we continuously expand them. Components are sorted by manufacturers and by types. The cross-module library management system with custom library groups and search filters allows the user to seek through the libraries and quickly find what he needs.

### Search filters

Go to "Objects \ Find Component" from the main menu in the Schematic or press

**Filter Off** button on the Place Component panel to customize the search filters.

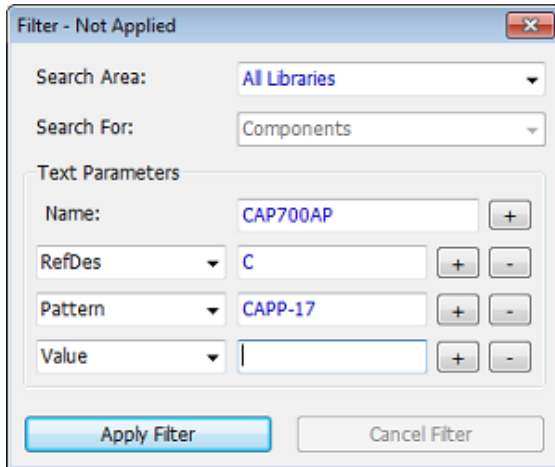

In the pop-up dialog box specify the search area: all libraries, current library group or current library, and type in the name or part of the name of the component. DipTrace allows for filtering components by RefDes, Value, Pattern, Manufacturer, Datasheet or Additional Fields. Press **+** or **-** buttons next to the corresponding search filter to add or delete the search filter respectively. Use the drop-down list to select the search parameter.

As you can see in the picture, we search for CAP700AP capacitor with "C" RefDes and CAPP-17 pattern.

Press **Apply Filter** and close the dialog box. You see that only filtered components, which correspond to the search filters are visible on the Place Component panel.

The state of the search filters is always displayed on the Place Component panel – "Filter ON/OFF." To disable the search filters, open the search filters dialog box, and press **Cancel Filter**.

### Place component

You can find and place components with the **Place Component** dialog box ("Objects \ Place Component" from the main menu in Schematic). There are two sections in the pop-up dialog box: Libraries and Components. Select library group from the drop-down list, then select a library, and, finally, select component from the corresponding list. Press **Filter ON/OFF** button to customize and apply the search filters.

*"Objects \ Place Component" dialog box is similar in the PCB Layout.*

For example, we need a component that contains "232" in its name, but we do not remember the other characters, letters or even a possible library. Press **Filter ON/OFF** button, select **Search area: All Libraries**, type in "232" in the **Name** field of the filters dialog box, and press **Apply Filter**. DipTrace has found 274 components with "232" in their name. Components are in the list right below. Select component, now you see its schematic symbol or press **Display Pattern** to see how it looks on the PCB.

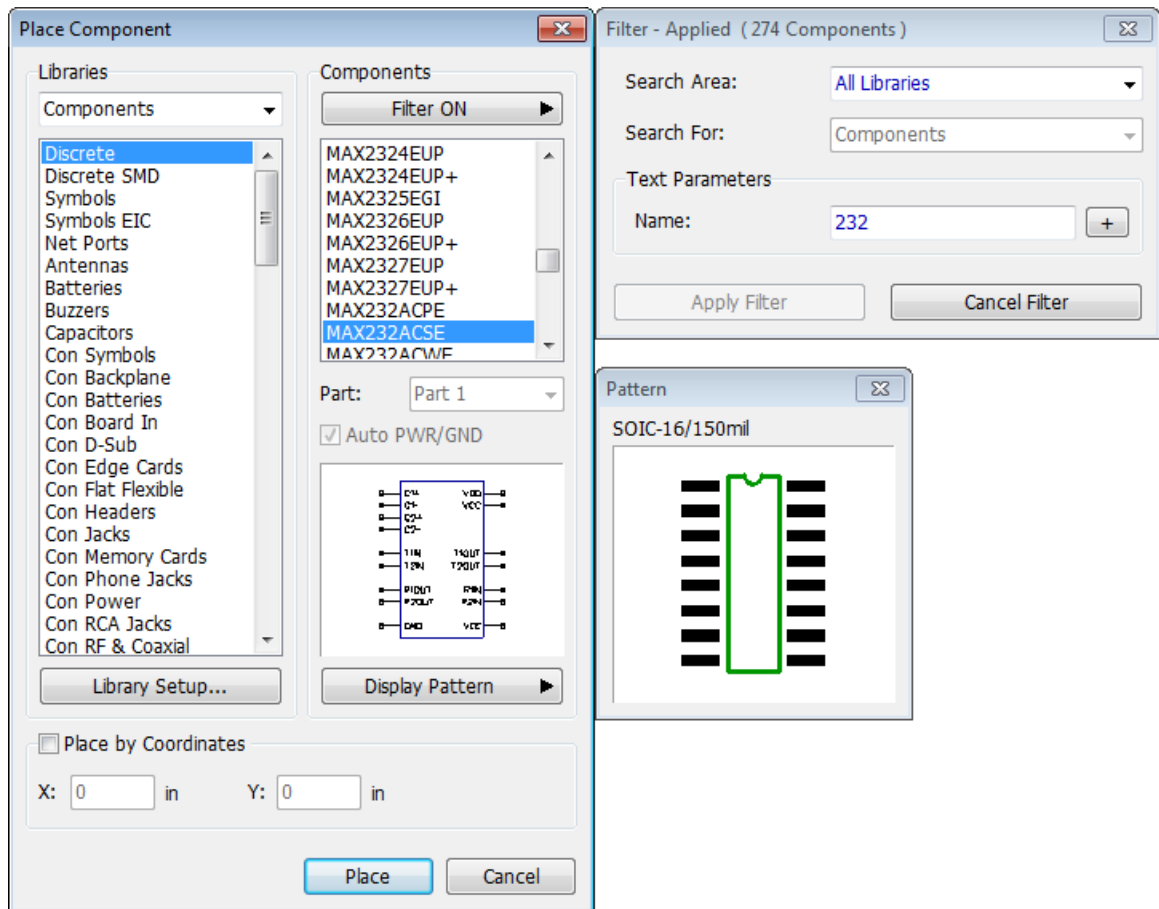

Add more search filters to narrow the results.

Press **Place** button and left-click on the design area to place selected component or check **Place by Coordinates** checkbox and enter exact coordinates where you want that component. This dialog box has all necessary tools to work with multi-part components as well.

### 5.3 Reference Designators

Now we work with schematic examples located in the "Documents \ DipTrace \ Examples" folder. Open Schematic\_2.dch file.

This project demonstrates applications of various DipTrace features. However, we will experiment with some basic principles of working with Reference Designators in the Schematic.

Current Schematic contains 23 capacitors from C1 to C24 (C19 is missing).

#### Optimize RefDes

While editing a principal circuit, sometimes you need to insert or delete components. Let's add a capacitor to the schematic, select **CAP** component from the **My Library** or **Discrete SMD** library and place it on the design area. We want "C5" RefDes for this component, but the software automatically assigned the "C19" RefDes, because C19 was missing and C5 existed on the schematic. Change the RefDes, right-click on this capacitor, and select the first item from the submenu, enter "C5", and press OK. The warning message suggests to rename the component and shift the RefDes numeration, press **Yes**.

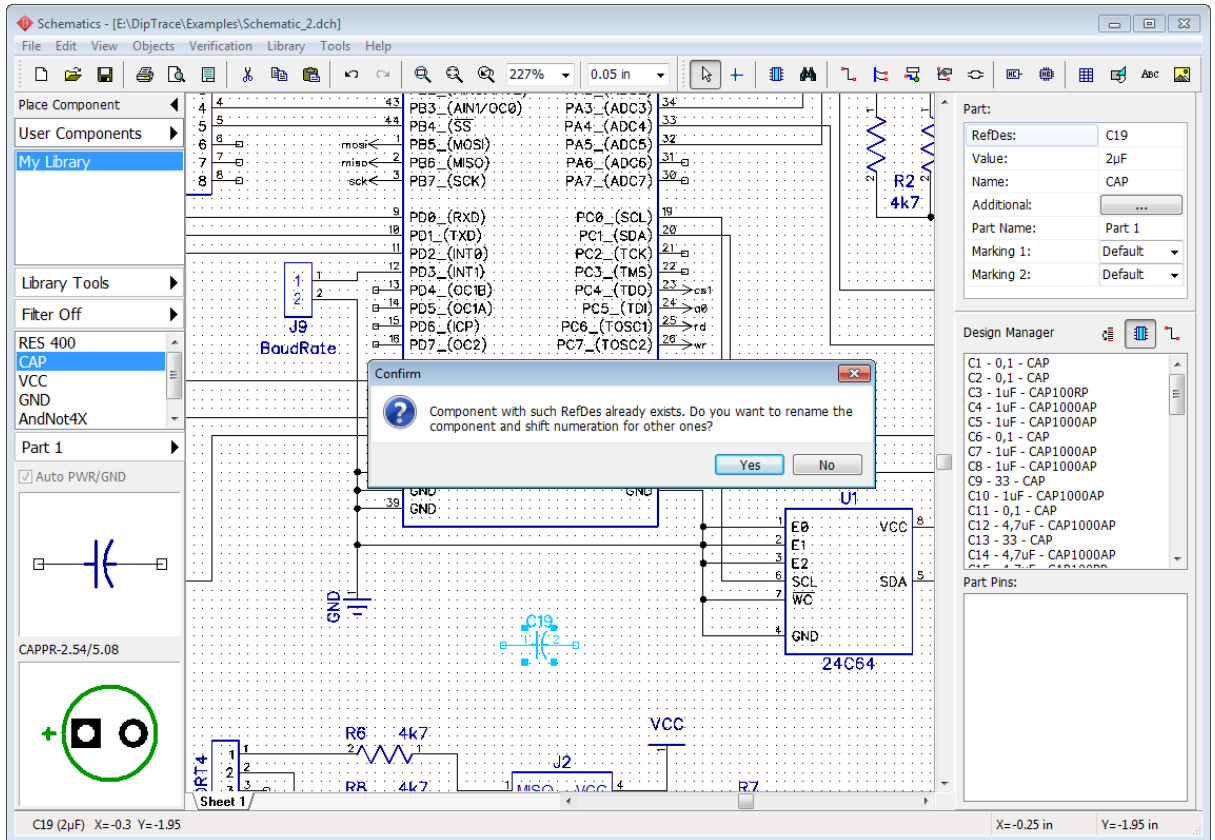

The C19 capacitor is now C5 and the old C5 became C6 and so on till C18 capacitor which is C19 now. See the design manager panel to the right to find out that C19 reference designator is not missing anymore because you have inserted C5 and C5 – C18 RefDes

indexes were shifted ( use  button to sort the components in the list). Now we have the correct array of RefDes indexes for all capacitors.

Now rename the C5 capacitor to C30, then check the list of capacitor designators on the

**Design Manager** (*Ctrl+2* to show/hide the Design Manager, press  button to sort the components in the list) – C5 and capacitors with C25 till C29 indexes are missing. To correct this issue, right-click on any capacitor, and select **Optimize RefDes**, then select **RefDes "C"** – C30 becomes C24. The reason is simple – while optimizing the RefDes, DipTrace removes all empty places in the designator index array. Therefore C6–C24 become C5–C23, and C30 becomes C24.

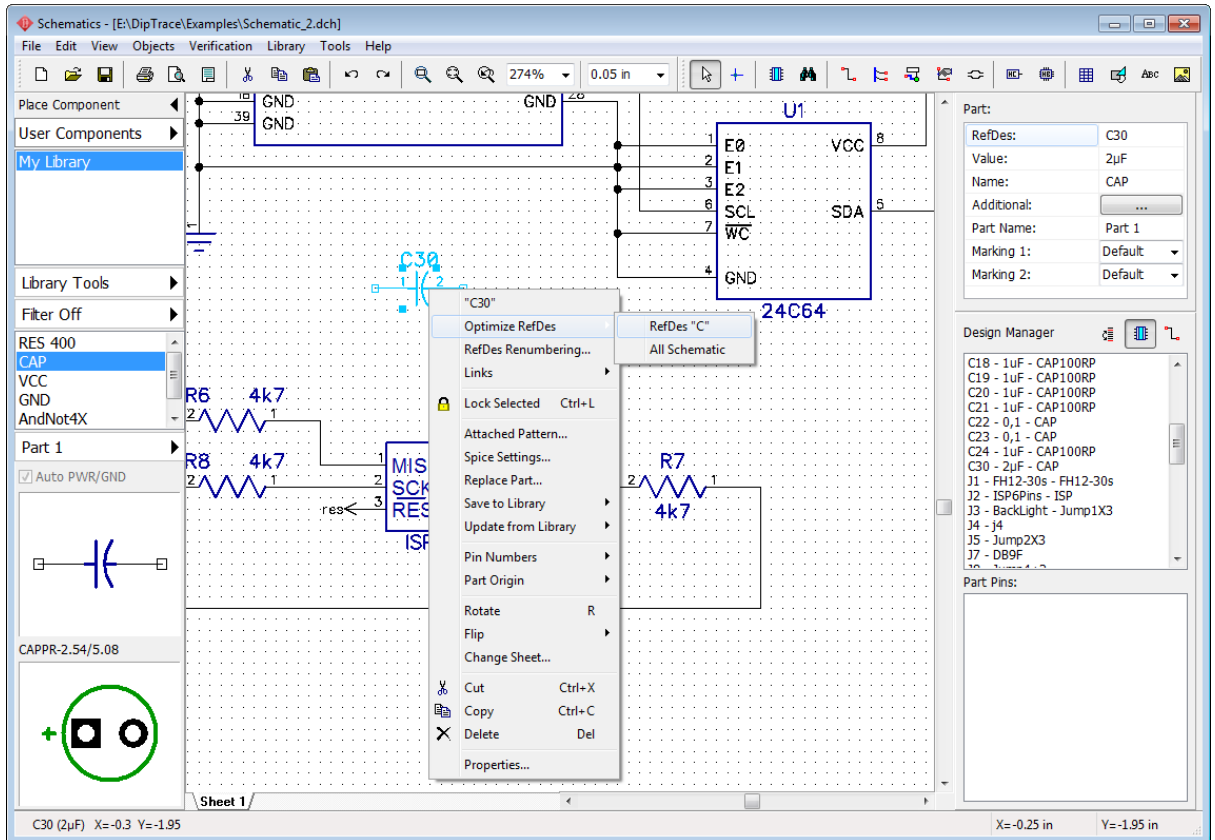

### RefDes renumbering

What if we need to renumber Reference Designators in a very easy way that makes it simple to navigate through the schematic? Select "Tools \ RefDes Renumbering..." from the main menu. In the pop-up dialog box do not change the **First Index** (starting point of renumbering) and **Page Step** (if page step = 100, the designators on the second page are R101, R102, IC101, etc.). Now specify the renumbering direction: in rows or columns, and choose how DipTrace is going to count components while renumbering. There are components of different sizes and shapes. If we choose **Top-left** in the **Component Position** section of the dialog box, DipTrace renumbers components, based on the position of the top-left corner of each component. If you choose **Origin**, the software considers component's origin to determine its position.

*Notice that renumbering always goes from left to right and from top to bottom of the circuit.*

Press **OK** to renumber all components.



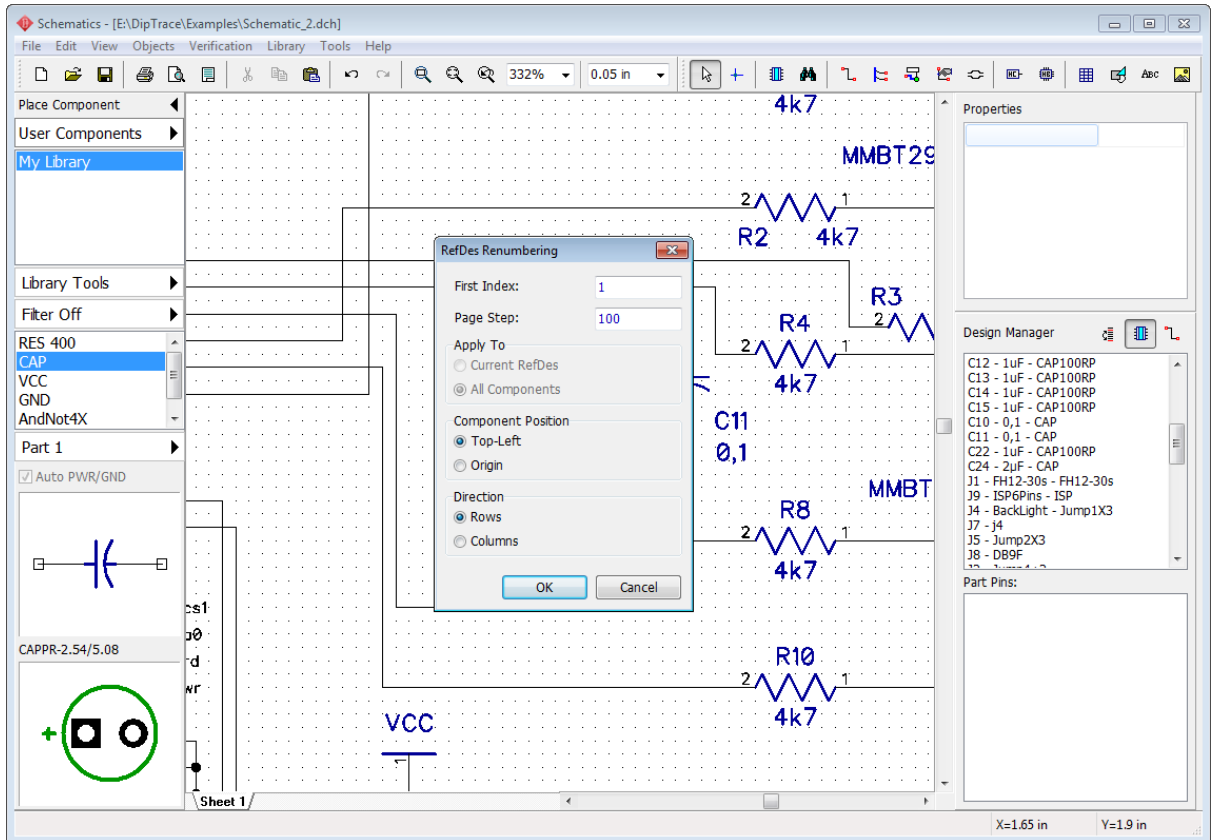

If you need to renumber only the designators of components of selected type, right-click on one of the components, and select **RefDes Renumbering** from the submenu. You see a typical **RefDes Renumbering** dialog box, but this time you can apply renumbering to the current RefDes.

*RefDes Renumbering works the same in the PCB Layout.*

Close DipTrace Schematic **without** saving progress and launch the PCB Layout module.

## 5.4 Placement and autorouting

DipTrace has advanced placement features and integrated auto-placer. This makes placement and layout optimization much easier.

Launch the PCB Layout module, select "File \ Open", and select "C:\Users\\Documents\DipTrace\Examples\Schematic\_4.dch" and use the schematic rules for this layout. You get something like in the picture below. The layout is chaotic because components are placed just like their symbols in the schematic. Manually arranging components would be a waste of time, this is why we recommend using the automatic arrangement, but, first, let's start with the board outline.

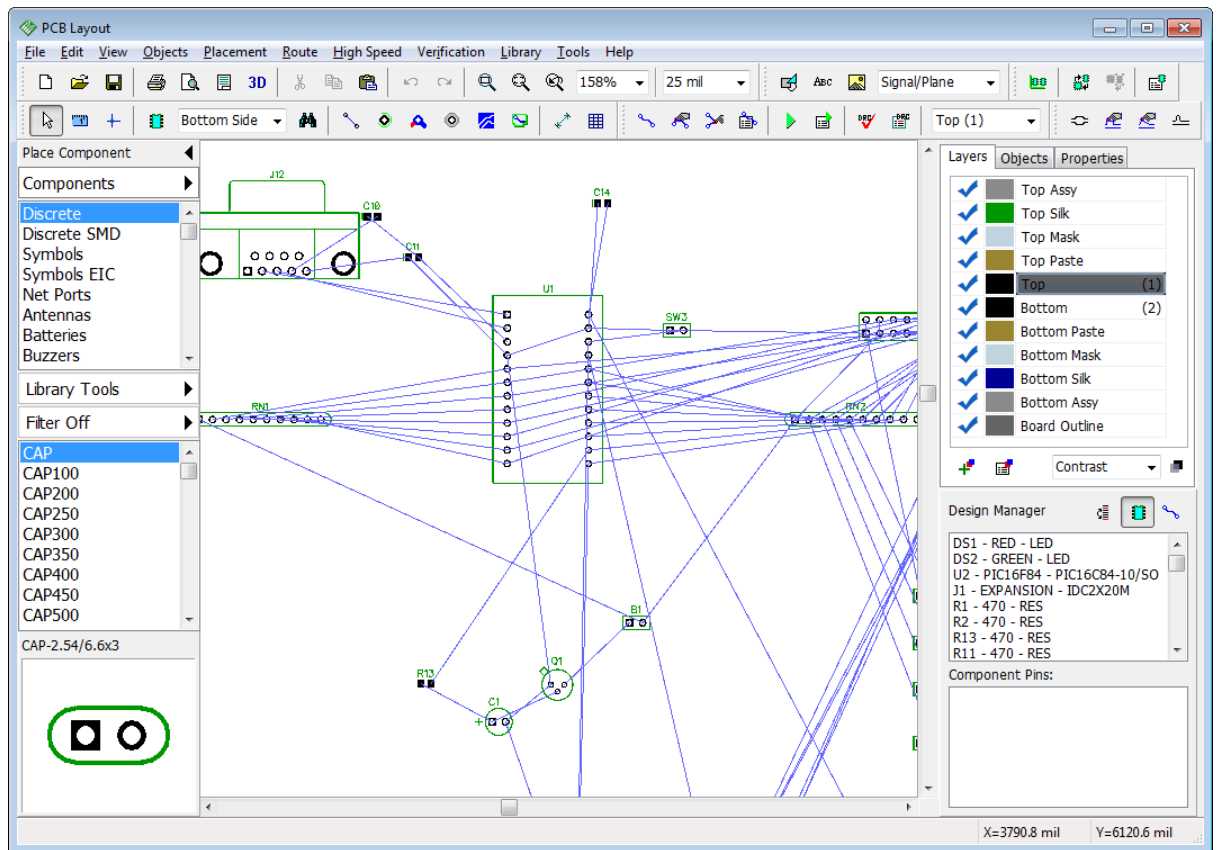

### DXF import

We import the board outline from the DXF file. Select "File \ Import \ DXF" from the main menu and open "C:\Users\Board Outline DXF layer, and specify **Convert to: Board Outline** in a drop-down list below.

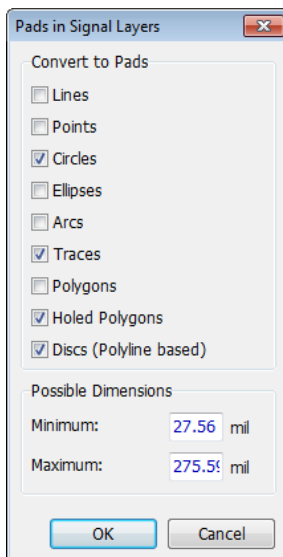
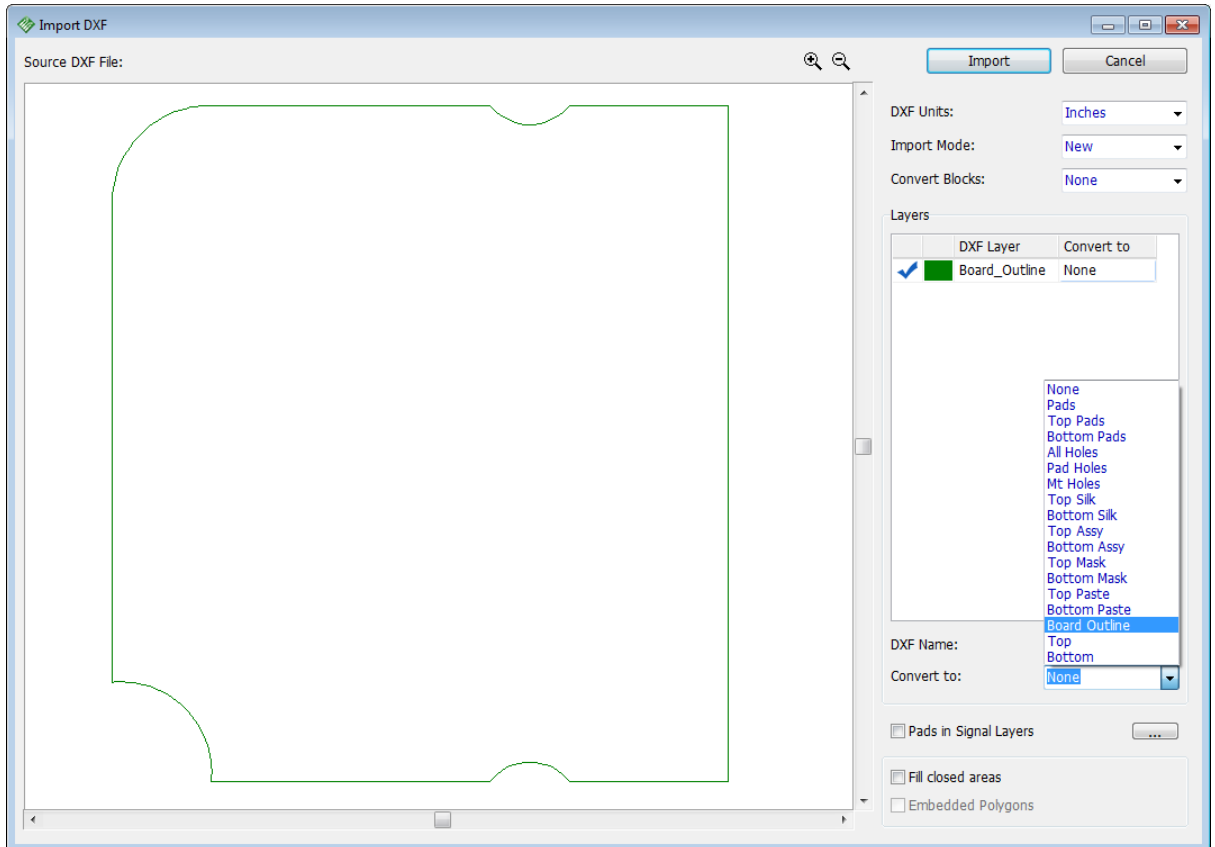



When importing component drawings or entire layout from the DXF format, you can **Fill closed areas** and cut holes using **Embedded polygons** (usually DXF designs are made from the outlines without fills). This feature works for copper and mask/paste layers only.

If you are importing pads in signal layer, then you can check the **Pads in Signal Layers** checkbox, and press  button to specify what shapes should be automatically converted into pads and their possible dimensions.

Select **Import mode: Add** to add board outline to existing layout, make sure inches are selected, and press **Import** button in the upper-left.

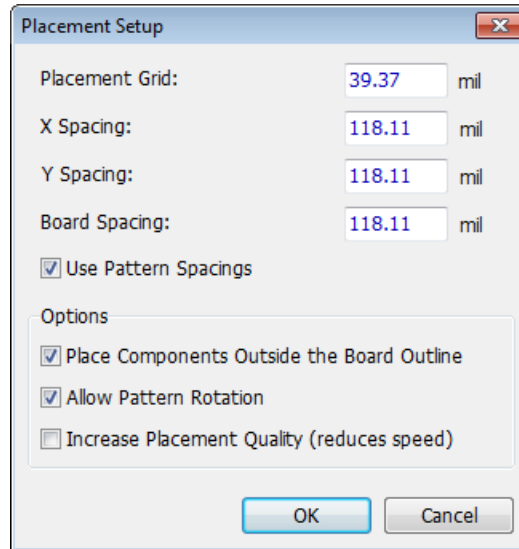
The board outline appears on the design area, but components are still messed. Select "Placement \ Placement Setup" from the main menu:



Check **Place Components Outside the Board Outline** checkbox to arrange components near the board outline. Keep other settings like in the picture above (notice that values are in mils, you can change units with *Shift+U* hotkeys). Click **OK** to apply changes and press  button on the Placement toolbar or select "Placement \ Arrange Components" from the main menu.

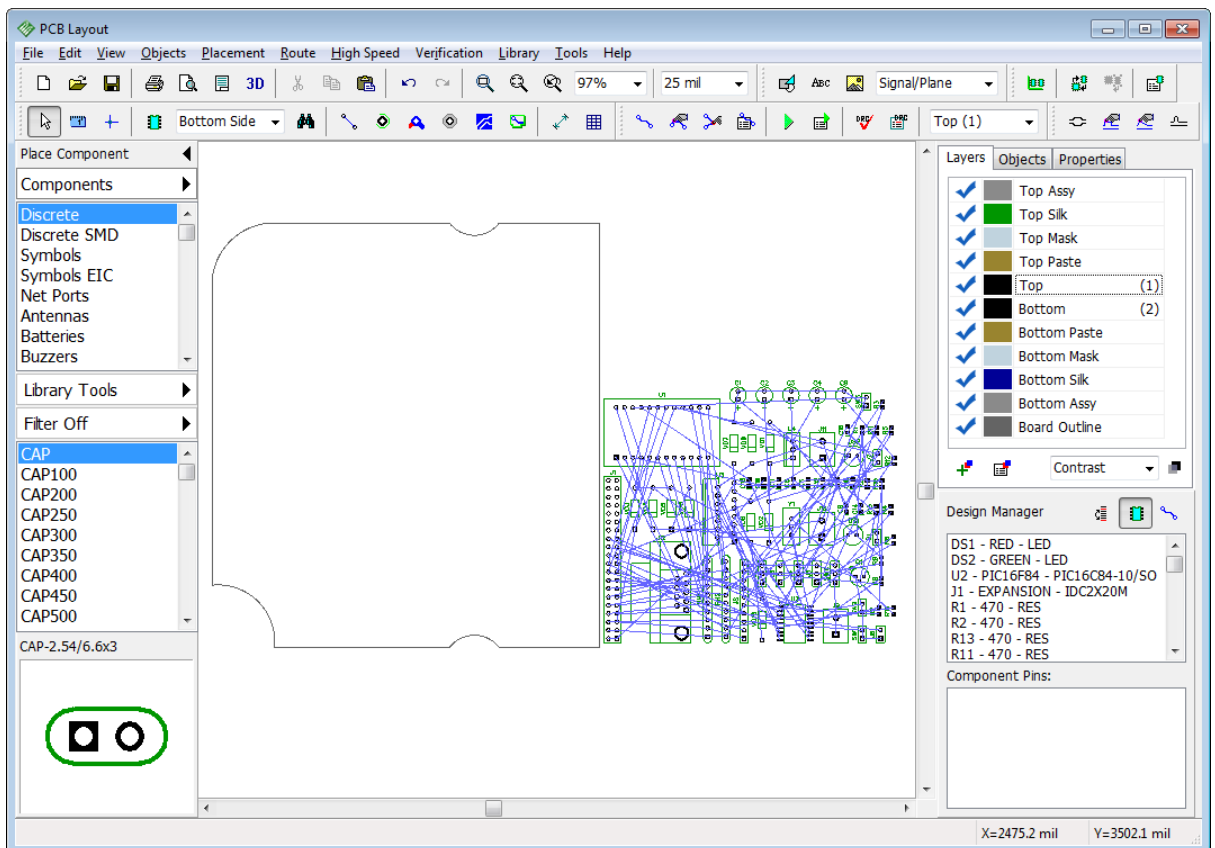

All components are now located in one place near the board outline.

Notice that **Arrange components** feature is not the same as **Auto-placement**.

Automatic placement creates a layout with a minimum possible total length of connections

between the pads of components. **Arrange Components** feature simply brings all components to one place and makes it easier to work with them.

However, in real life manual placement is widely used, because most of the time we have certain places for certain components. DipTrace allows the user to combine automatic and manual placement on a single circuit board.

### Placement by list

Select "Placement \ Placement by List" from the main menu, then in the pop-up dialog box select component from the list (left-click it), move the mouse to the board outline, and click inside the board outline to place selected component there.

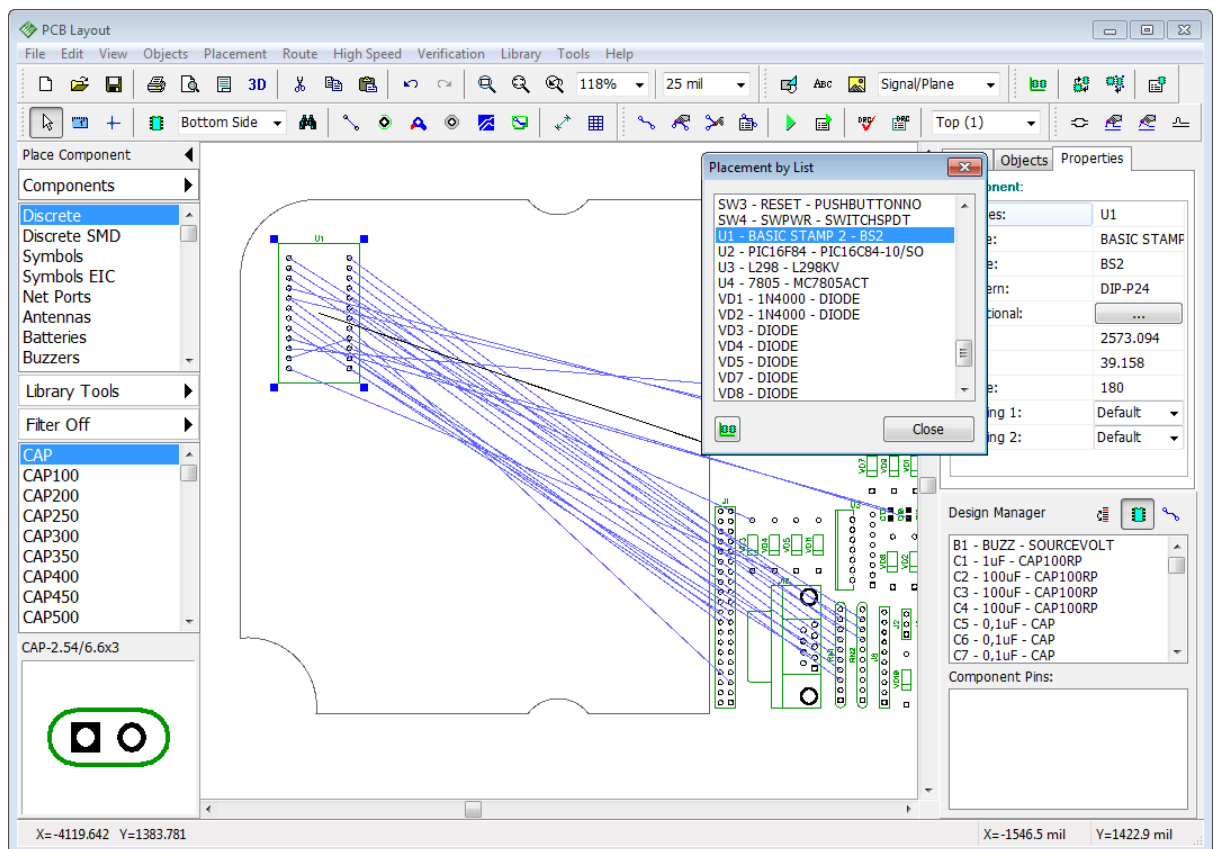

Component disappears from the list after placement (the list shows only components outside the board outline). Position U1, U2, U3, J1, J8, J12, RN1, and RN2 components manually, like in the picture below. You can optimize connection lines with *F12* hotkey or uncheck the **Ratlines** item on the **Objects** tab on the Design Manager to hide the ratlines. Close the **Placement by List** dialog box when done.

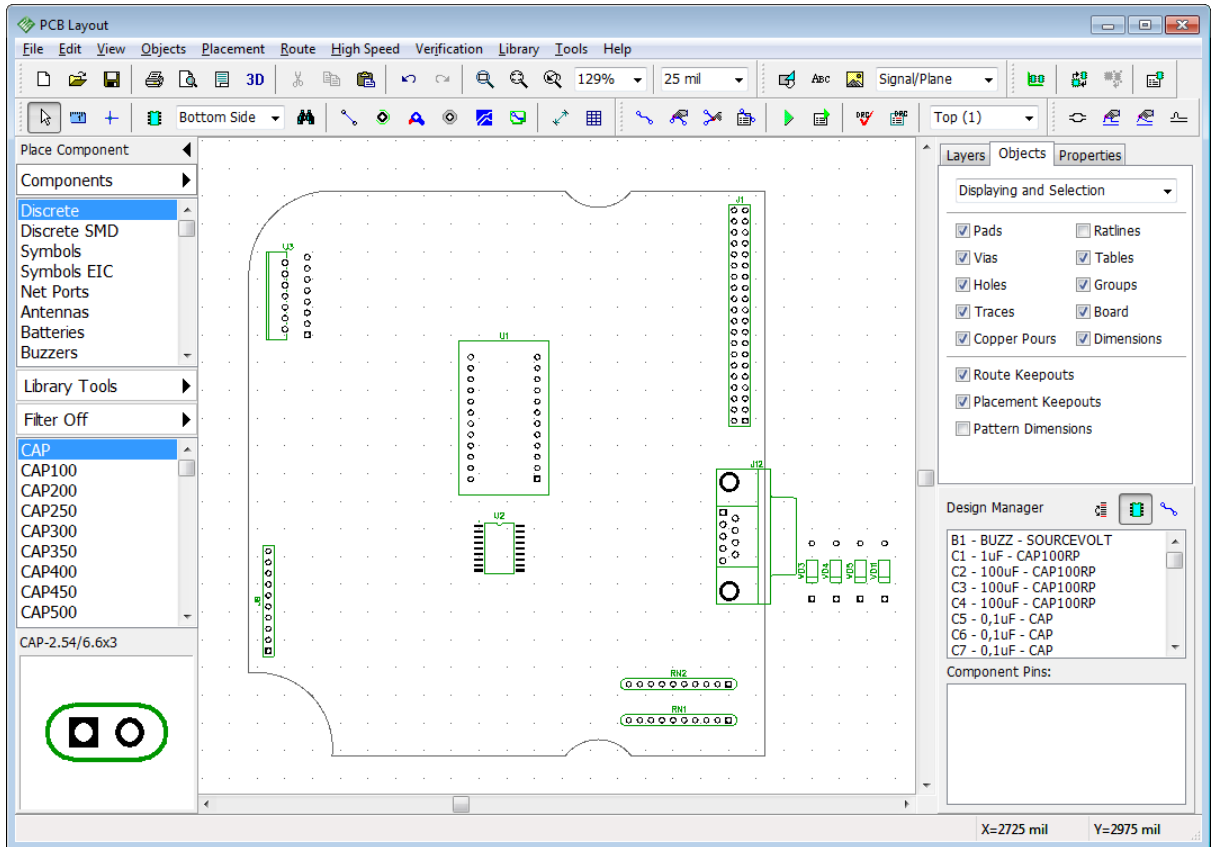

### Custom component clearance

Default component clearance is set with X and Y spacings in the **Placement Setup** dialog box. We need all other components to be at least 20 mm away from the U3 component. Therefore, we will set a custom clearance for this component. Right-click on the U3, and select **Properties** from the submenu, then open the **Placement** tab, and define: **Use: Custom** and **Value: 800 mil** (approx. 20 mm). Click OK to close the dialog box and apply custom clearance.

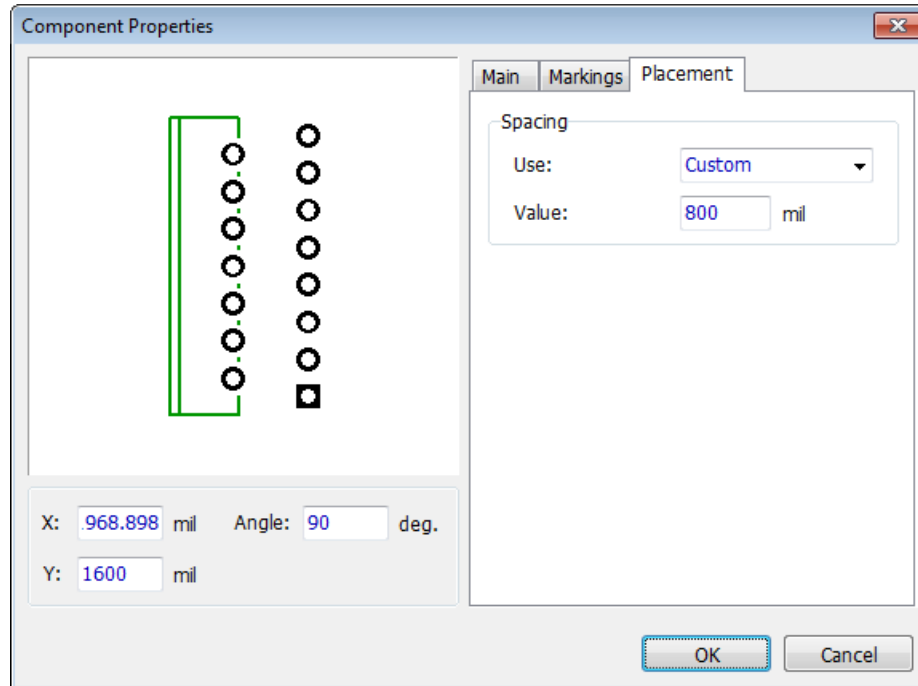

Now select all components which are already on the circuit board, and lock them (*Ctrl+L* hotkeys).

### Auto-placement

We do not have special requirements for other components. Therefore, we can place them automatically with 5 mm spacings. Change measurement units (*Shift+U* keyboard shortcut). Select "Placement \ Placement Setup" from the main menu, change X Spacing and Y Spacing to 5 mm, and set 3mm board spacing. Make sure that **Allow Pattern Rotation** checkbox is checked (sometimes it is better to turn it OFF, for example, for single-sided boards with jumper wires). Uncheck **Place Components Outside the Board Outline** and make sure **Use Pattern Spacings** item is checked, this allows the program to use 20 mm custom clearance of the U3 component. We do not recommend to check **Increase Placement Quality** option now (you can try it later).

Press **OK** to apply changes, and then press  button on the Placement toolbar or select "Placement \ Run Auto-placement" from the main menu. DipTrace looks for the best location for each component. You will get something like in the picture. Notice that Design Manager panel is hidden (*Ctrl+2* hotkeys), the ratlines are also hidden.

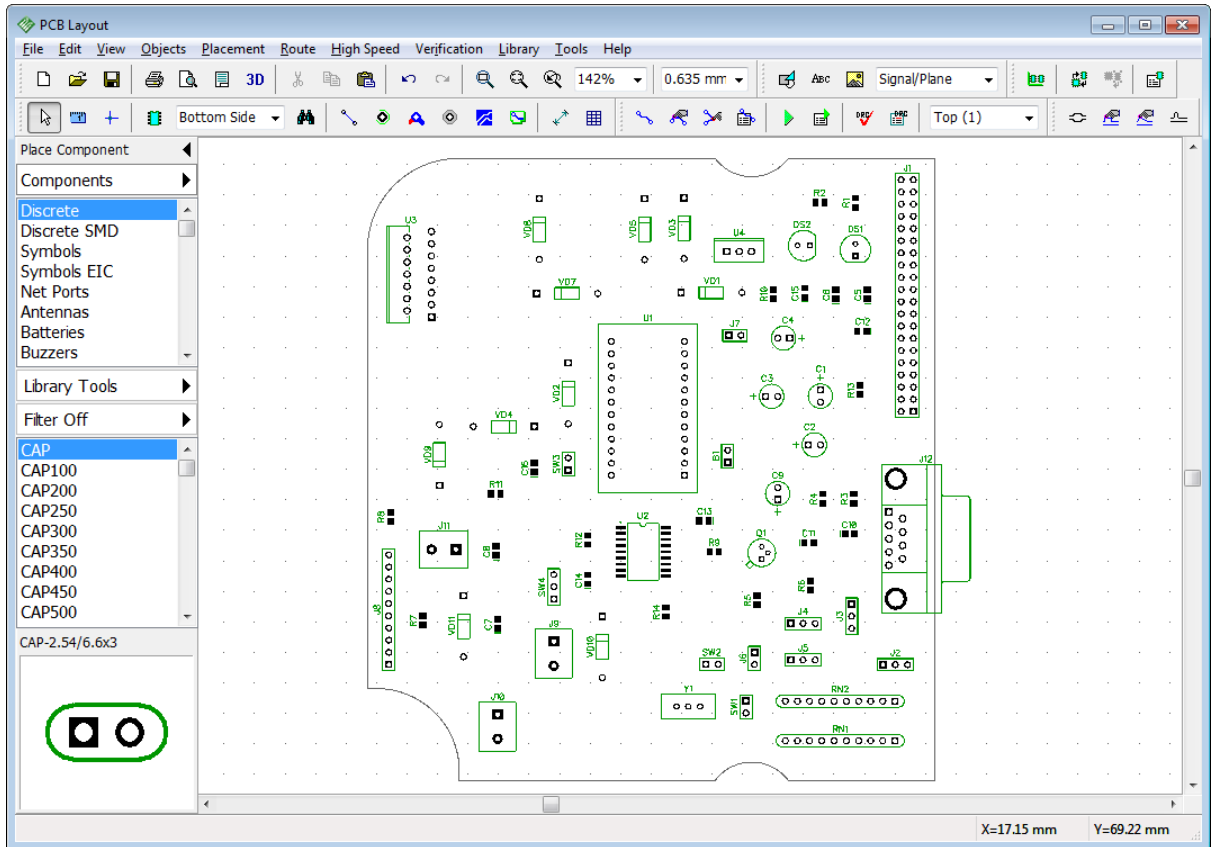

Some connections are not optimal because we have placed large components manually. If you auto-place the entire board, you can get better results, but usually, this is not the option in real life.

It's clearly visible that there is no component on the board closer than 20 mm to the U3 because of the custom clearance.

### Autorouting with net classes

Check via properties in the "Route \ Via Styles" main menu item. One via style is enough for this project (we use 1.2 mm via with 0.6 mm hole). Now we need to create a separate net class for Power and Ground nets because traces of these nets should be a bit wider. Select "Route \ Net Classes" from the main menu. All nets belong to the Default class. Press **Add** button to create a new net class, then select it from the list, and enter its name ("POWER"). Specify: **Trace Width: 0.6 mm, Clearance: 0.6 mm**. Press **Clearance Details** button and in the pop-up dialog box set **Trace to Pad: 0.5 mm**. Now press **OK**. Select VCC and GND nets from the list of all nets of the project in the lower-right corner of the dialog box (use *Ctrl* key for multiple selection) and add them to the POWER net class (press  button above the list).



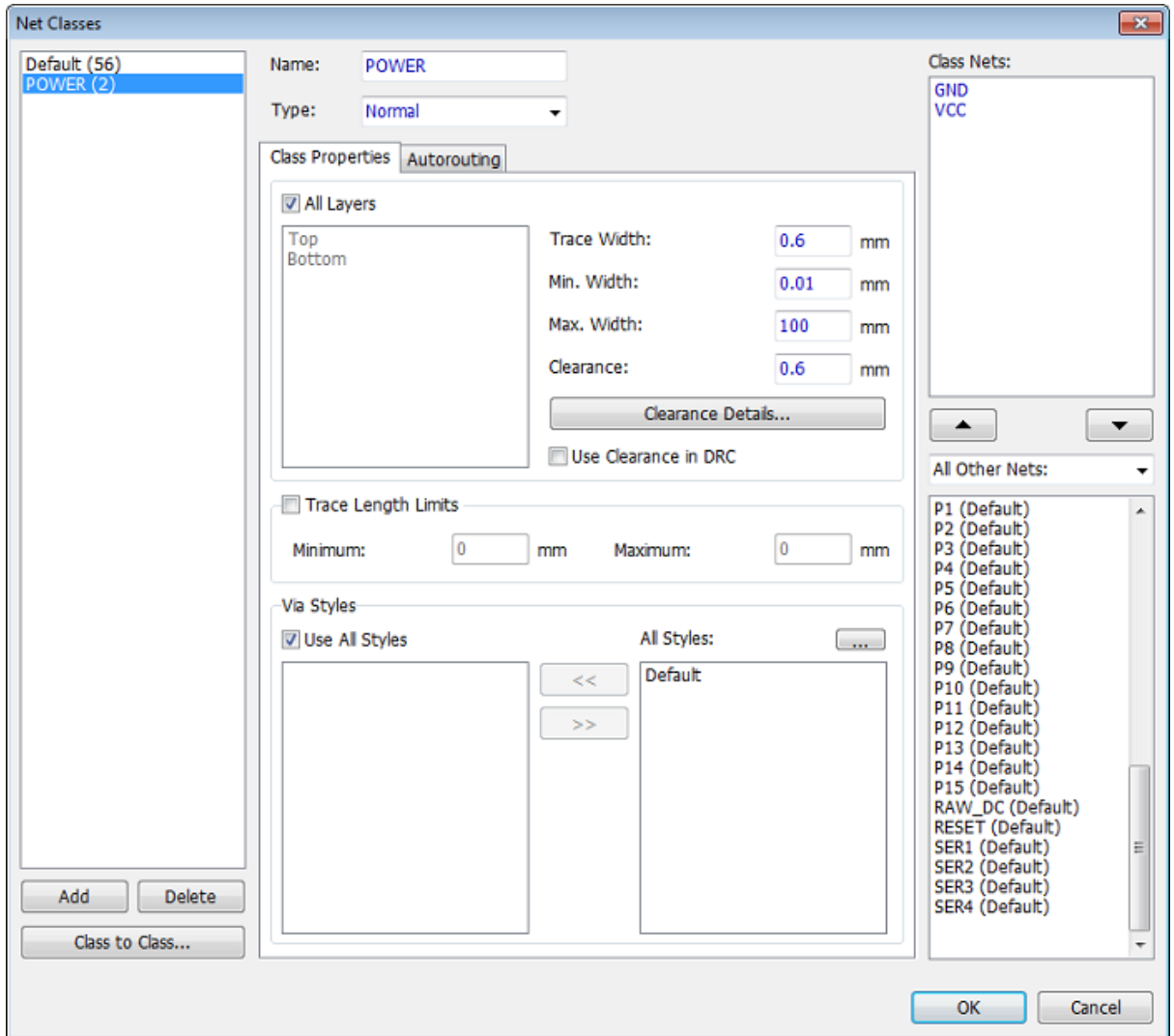

Now select Default net class, and specify the following parameters: **Trace Width: 0.4 mm**, **Clearance: 0.4 mm**, **Trace to Pad: 0.3 mm**. Use all via styles for both net classes (as you know, we have only one via style). Press **OK** to close the **Net Classes** dialog box. Make sure that Shape Router is active ("Router \ Current Autorouter\Shape Router"), then go to the [Autorouter Setup](#)<sup>38</sup> dialog box, and in the **Settings** tab uncheck **Use Priority Layer Directions**.

Now press *Ctrl+F9* or the  on the Route toolbar to launch the autorouter. In a few second you will get the results. Change layer colors if you want.

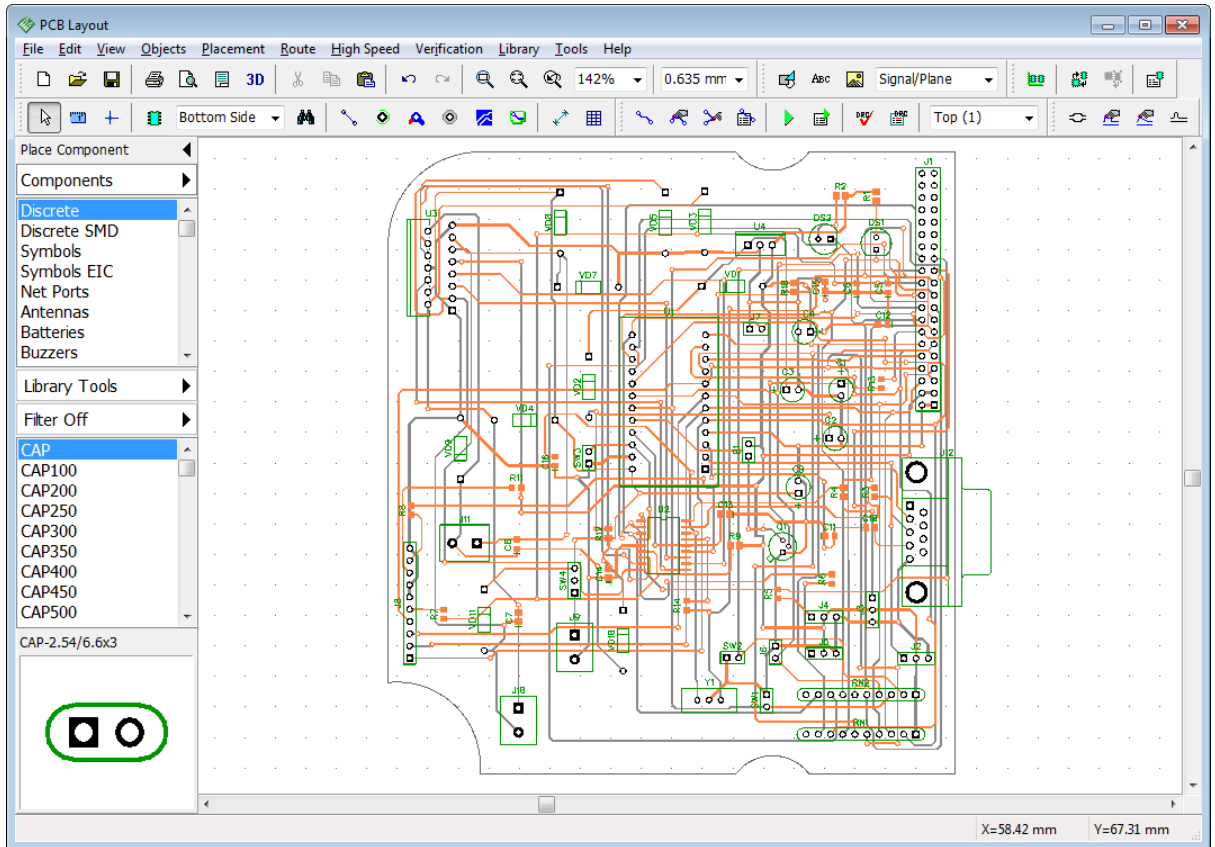

A detailed description of the autorouter settings available in the PCB Layout Help ("Help \ PCB Layout Help" from the main menu). If you still have some unrouted nets, **Undo**, change trace width/clearance, placement or other settings, then launch autorouter again. However, if you follow the aforementioned instructions you should not get any problems.

## 5.5 Layer stack

DipTrace allows for comprehensive control over the stack of conducting and insulating PCB layers in the **Layer Stackup** dialog box and generates a stack table that clearly documents the PCB stack for manufacturing engineers.

Launch DipTrace PCB Layout module and open the PCB\_6.dip file from the "Documents/ DipTrace/Examples" folder. It is a 4-layer circuit board. Select "Route \ Layer Setup" from the

main menu or press  button on the **Layers** tab, then press the **Layer Stackup** button in the **Layer Properties** dialog box.

In the **Layer Stackup** dialog box, you can see the table which represents a printed circuit board's cross-section. In our case, DipTrace has automatically selected the **4 Layers Default Stackup** in the **Template** drop-down list because this design has two signal layers.

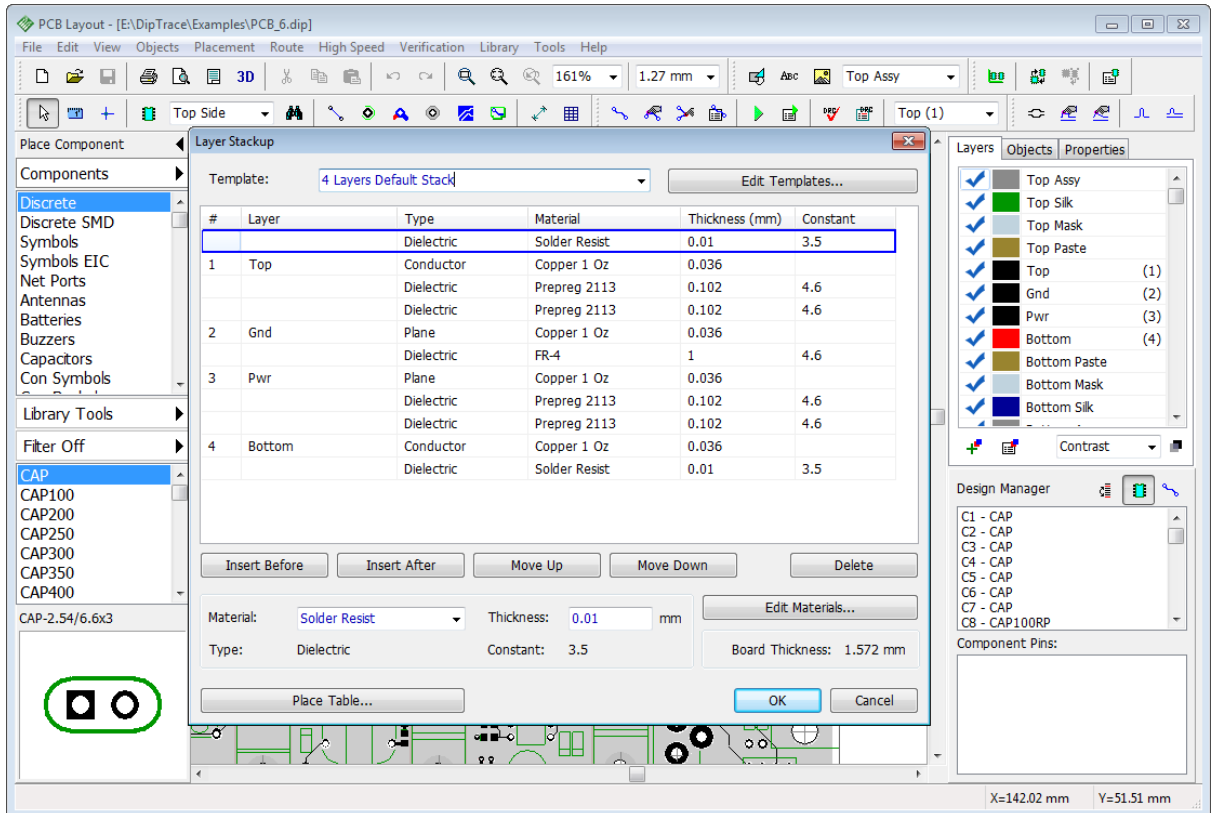

There are many variations of PCB stacks on the market, but default stackups available in the software are usually the most common and thus the cheapest ones. However, you can create any stack. As you can see from the list, this 4-layer stackup is based on a single FR-4 core and additional prepregs to separate copper layers. For this tutorial, we will create a 4-layer stack based on two FR-4 core layers and capable of conducting large currents (like in the picture below). This stackup is a bit rare because of certain hole-plating difficulties, but it is a good example.

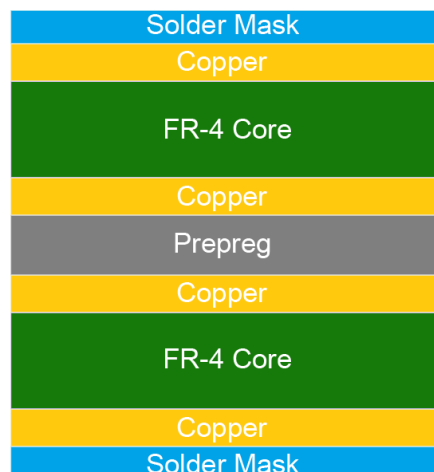

First of all, let's change the copper thickness to 2 Oz to conduct large currents. Usually, it is the thickest copper that does not skyrocket the manufacturing price and is available at most PCB houses in stock. Left-click on the layer #1 Top in the list, and select **Copper 2Oz** material from the **Material** drop-down list, then do the same for all conducting layers. Because the copper layers become thicker, the overall board thickness of the circuit board is

recalculated automatically.

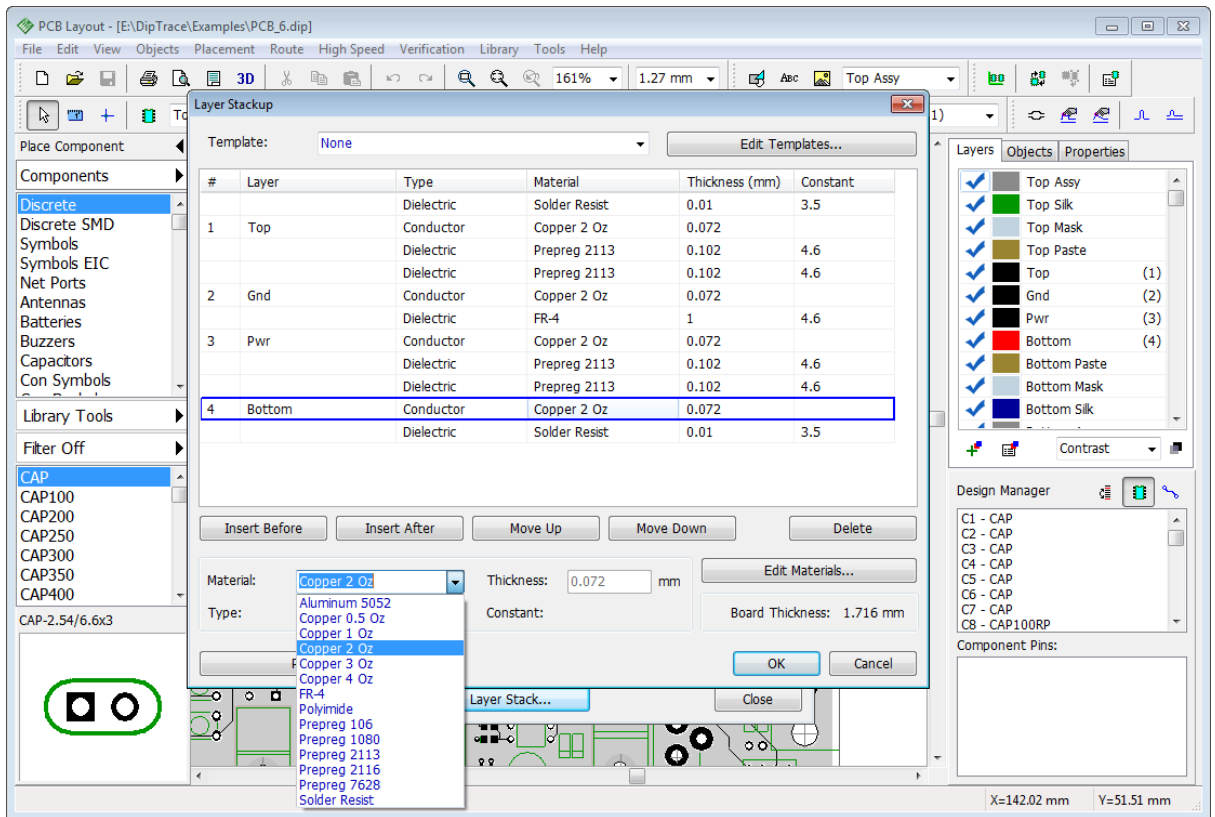

*Notice that you can use Shift + U hotkeys to change the measurement units on the go. All values are instantly recalculated.*

Now left-click on the Prepreg layer right below the layer #1 Top, and change its material to FR-4 substrate, then select another dielectric Prepreg 2113 layer, and move it down the stack (press the **Move Down** button). Now left-click on the FR-4 layer below the layer #2 Gnd, and move it down. The final steps are deleting one of the prepregs left, and moving the other prepreg up the list because we want to have double-layered 2113 prepregs separating the copper layers (like in the picture).

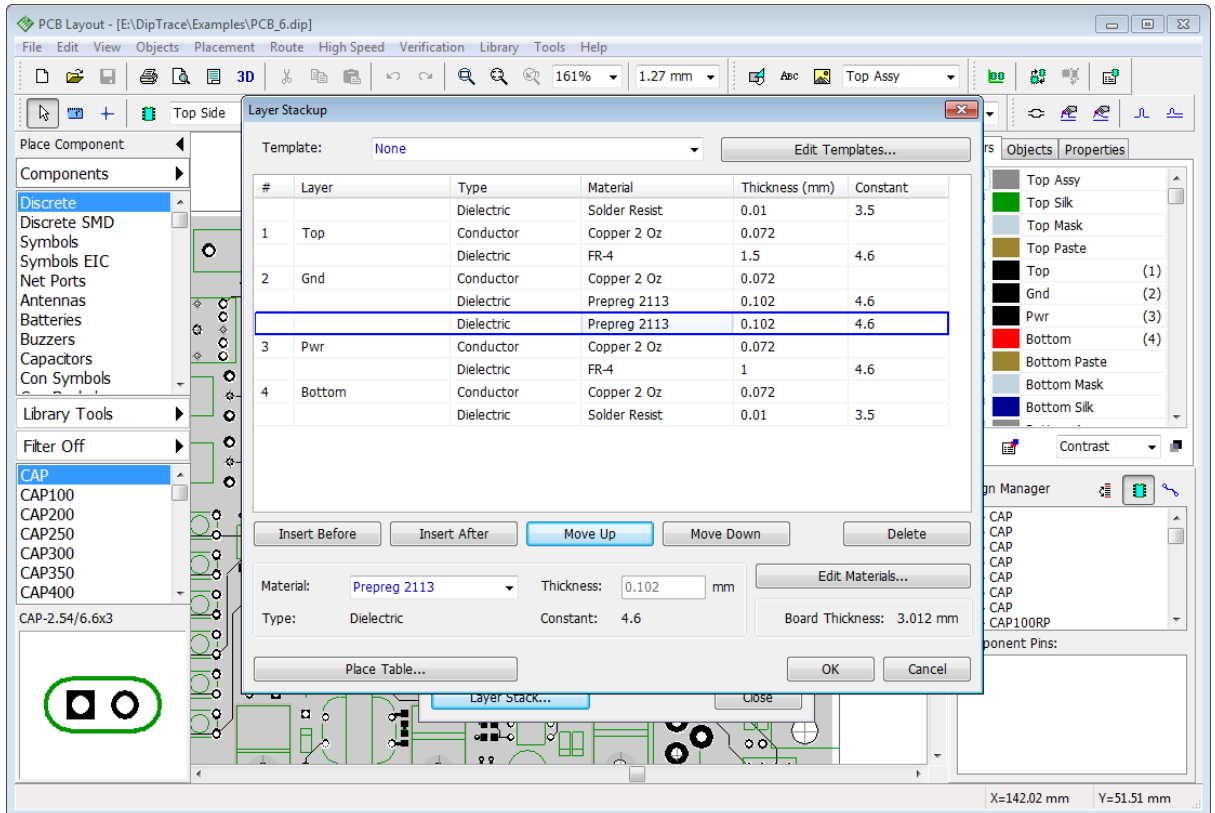

The final stage is documenting the layer stackup in the Gerber file for a PCB house. Press **Place Table**. In the pop-up dialog box, select a non-signal layer for placing the layer stackup table (Top Assy layer is the best choice). You can change fonts, measurement units and preview the total dimensions of the Layer Stackup table.

*Notice that you can use **Shift + U** hotkeys to change measurement layers on the go. All values are instantly recalculated.*

Press **Place**, and left-click on the design area to place a Layer Stackup table on that spot. The thickness of the layers in the stack influences the via height and is taken into account by [phase tune](#)<sup>[201]</sup> and [trace length measuring](#)<sup>[186]</sup> tools. Hence, the software can ask if you want to consider the stackup of layers for trace length calculation (if it is not considered yet).

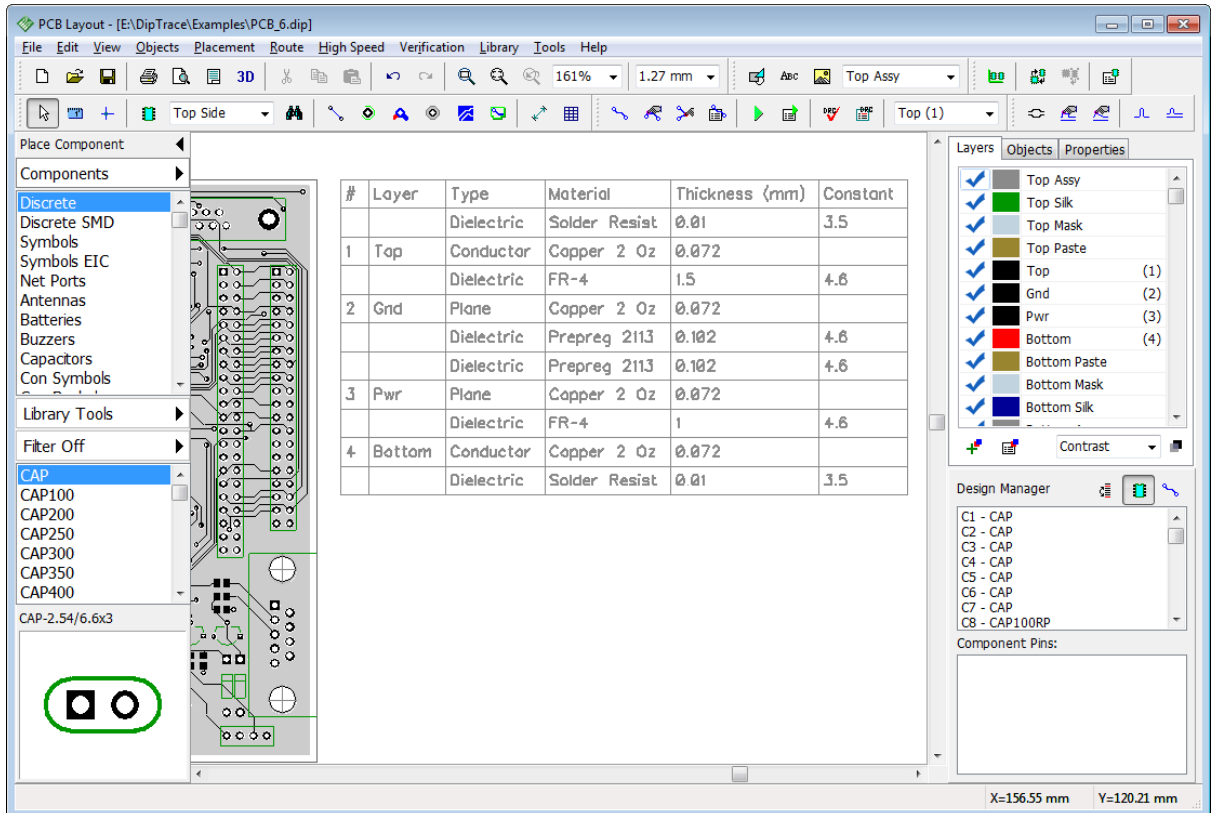

The color of the table depends on the color of the PCB layer. Now the manufacturing engineer can understand which layer stackup you prefer. However, it is better to consult your PCB house before making changes to the layer stack.

Don't save any changes in the PCB\_6.dip file.

### Add new materials to the stackup

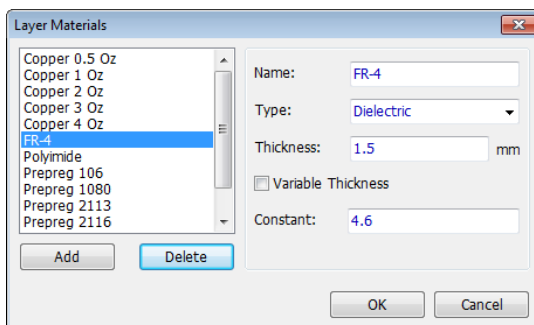

If you can not find the material you need in the list of available materials in the **Layer Stackup** dialog box, press the **Edit Materials** button. The **Layer Materials** dialog box pops up, here you can add new and change properties of existing materials (Type, Thickness, and Dielectric Constant). All materials are divided into three basic types: Conductor, Plane, and Dielectric. Use the corresponding buttons to add/delete/edit materials.

Check **Variable Thickness** box to allow for changing the layer thickness directly in the **Layer Stackup** dialog box.

## 5.6 High-speed nets and differential signals

### 5.6.1 Length matching

One of the core challenges with routing high-speed nets is controlling that certain critical signals arrive at correct time. To achieve signal synchronization, the copper tracks needs to be roughly the same length.

DipTrace has an elegant solution for matching trace lengths that helps when routing high-speed data buses or any critical signals that require precise timing.

We will use one of the standard DipTrace PCB examples for practice. Launch DipTrace PCB layout, and open the "BGA\_Autorouter.dip" file from the "Documents/DipTrace/Examples" folder.

If you're routing a high-speed bus, we recommend creating a separate net class for the bus. This will automatically create a DRC length matching rule. However, you can also select several nets and generate the length matching rule for the DRC without creating a net class.

### Length matching a bus

First of all, we need to create a separate net class that hosts all the nets that we need to length match (Net 306 - Net 310). In this case, we have the "Memory" net class with several nets connecting the U6 FPGA with the U14 memory module. When all traces are added to the net class, check the **Length Matching by Class** check box to create a new length matching rule verified by the DRC.

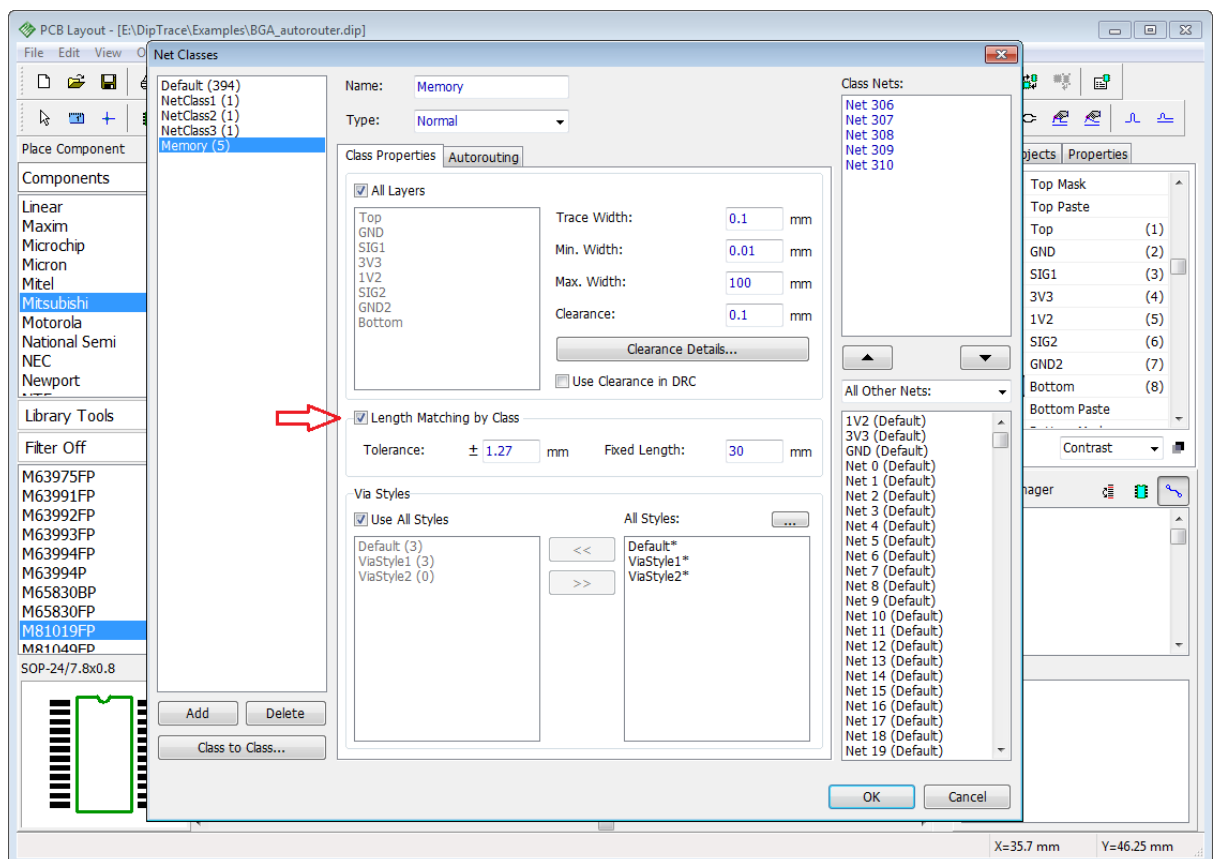

You can compare traces against the **Fixed Length** parameter or against each other with required **Tolerance**. Don't change the default tolerance value and let's say we need approximately 30-mm traces. Enter "30" in the **Fixed Length** field (the tolerance value automatically changes to 1.27 mm to display the range of 2.57mm over and under the fixed length). Press **OK** to create the net class and the rule. Now go to "High Speed \ Length Matching" from the main menu. Notice that we assigned the red color to highlight only the traces that we want to length match.

Select "High Speed \ Length Matching" from the main menu or right-click on the track, and select **Length Matching**, then **Open Length Matching** from the submenu. In the pop-up

dialog box, select **Memory** (actual name of the net class) in the **Rule** drop-down list. All nets of the memory data bus, which we assigned to the Memory net class, appear right below. Some of the nets are highlighted in red to show the length tolerance violation. Left-click a net in the list to show it on the design area or hover over a net to highlight it. In our case, there are three nets that should be longer to comply with the rule.

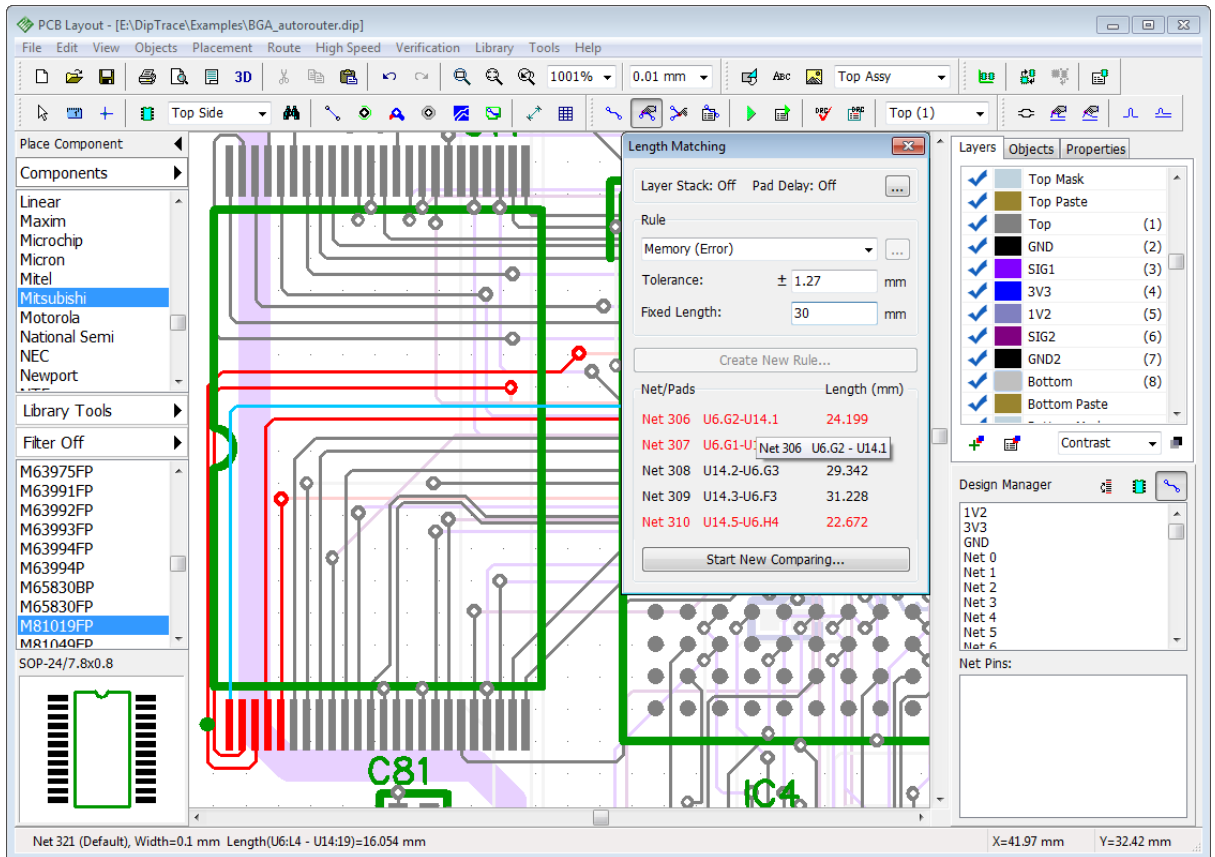

The most efficient way to make traces longer is drawing meanders.

### Add Meanders

Select "High Speed \ Add Meander" from the main menu or press  on the High Speed toolbar. Now hover over the trace, and drag and drop to draw a meander. Meanders are created one at a time. Move the mouse cursor to the right and create more meanders. The software helps to create meanders of the same size. Drag and drop meanders' lower vertices while holding the left mouse button to get something like in the picture below.

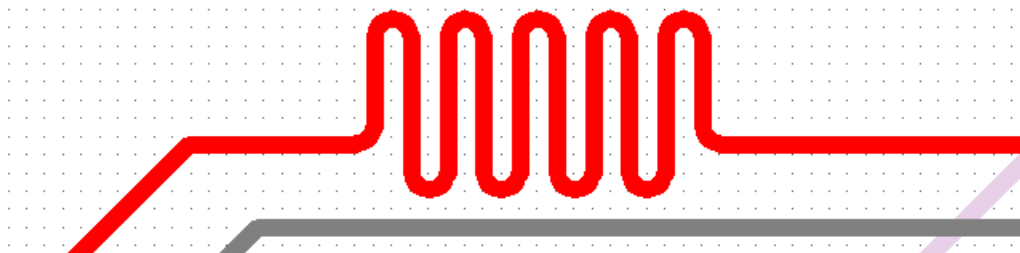

You can notice that the length of the trace is recalculated in real time. Once the trace length is around  $30 \text{ mm} \pm 1.27 \text{ mm}$ , the net is not highlighted in red anymore.



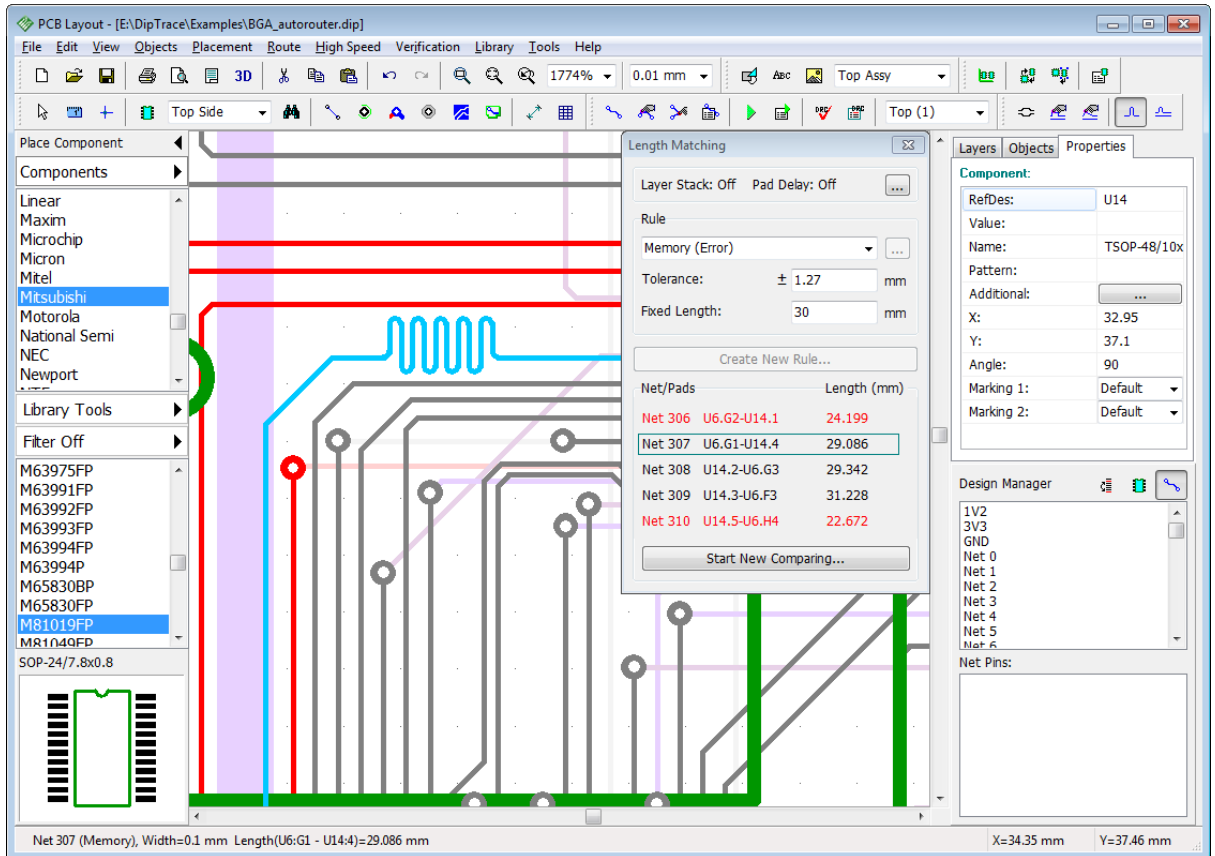



DipTrace can consider via height (derived from the [layer stackup](#)<sup>[182]</sup>) and [pad signal delay](#)<sup>[191]</sup> when calculating the trace length. Press the corresponding  button in the **Length Matching** dialog box, and check **Enable Layer Stackup** and **Enable Pad Delay** check boxes. Since there are traces crossing between layers, some of them might fall outside the length matching tolerance and will require more or bigger meanders.

### Edit Meanders

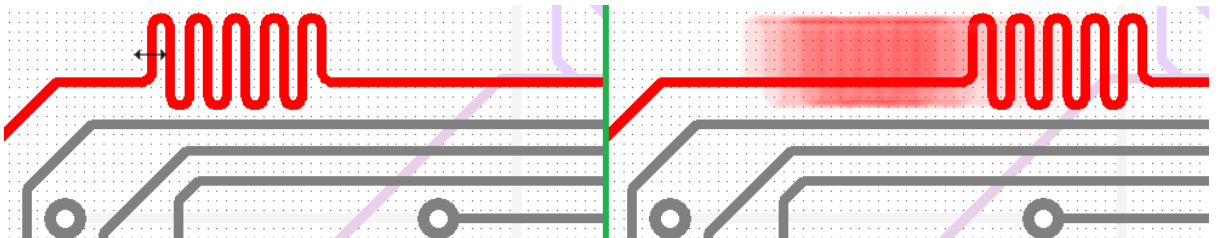
To push meanders along the trace segment, press the  button (if not in the **Add Meander** mode already), left-click on the trace segment opposite the preferred direction, and drag and drop meanders.



Notice that you can also move meanders along the traces and change meander's amplitude in the regular **Edit Traces** mode ( button).

By default, the gap between each meander is defined by the net class clearance. To set custom meander gap, right-click on the trace, and select **Meander Gap** from the submenu. In the pop-up dialog box, check **Value**, enter a new gap (for example 0.3 mm), and press **OK**.

Notice that it's better to avoid any sharp angles when routing traces of high-speed nets.

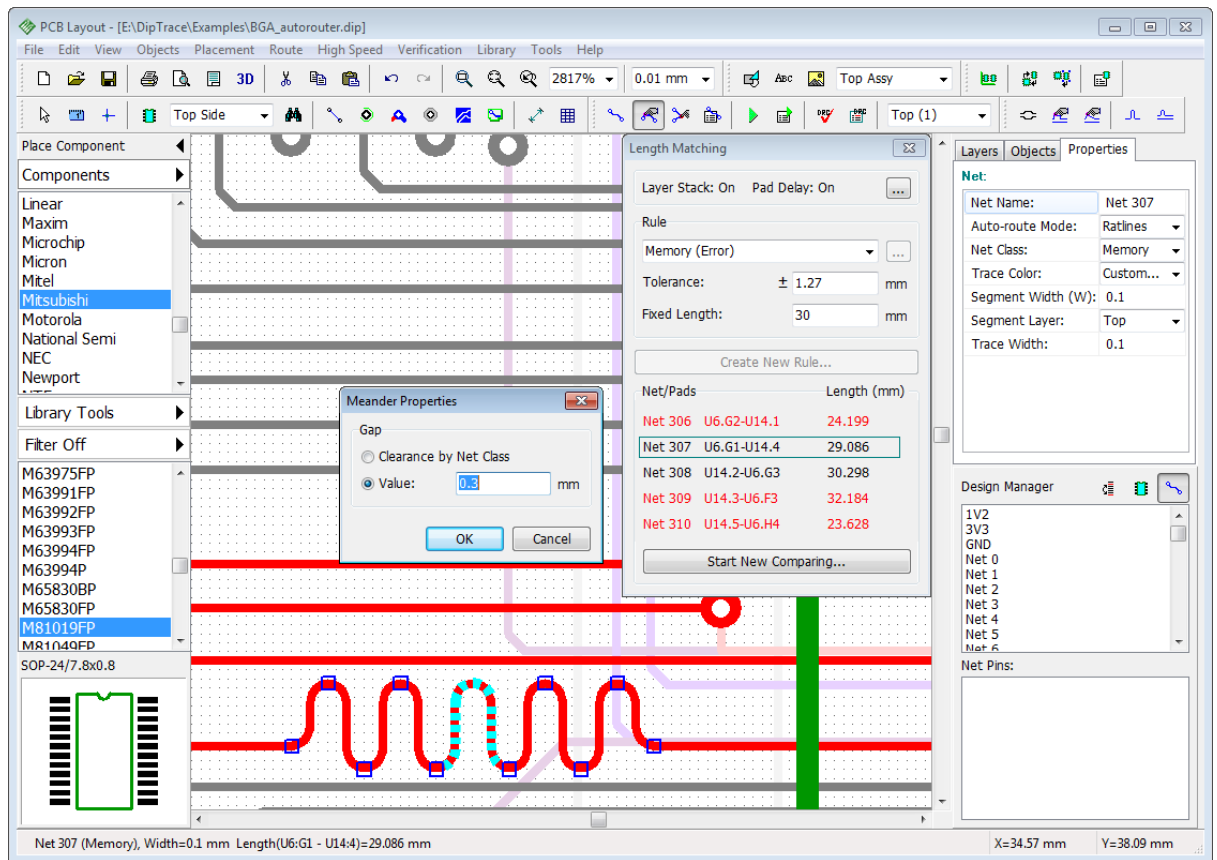

Fix all other errors by adding meanders and editing other traces.

### Length matching nets

You don't have to create a new net class just to length match some nets, just right-click on a trace segment, and select "Length Matching \ Add Selected Nets" to launch the Length Matching dialog box. You can also select several segments of different nets, and select "Length Matching \ Compare Selected Nets Only" from the submenu. In the **Length Matching** dialog box, you can compare nets against each other or against a fixed length.

You have to create a new rule (press **Create New Rule**, and enter a name in the pop-up dialog); otherwise, the DRC does not verify the length matching constraints.

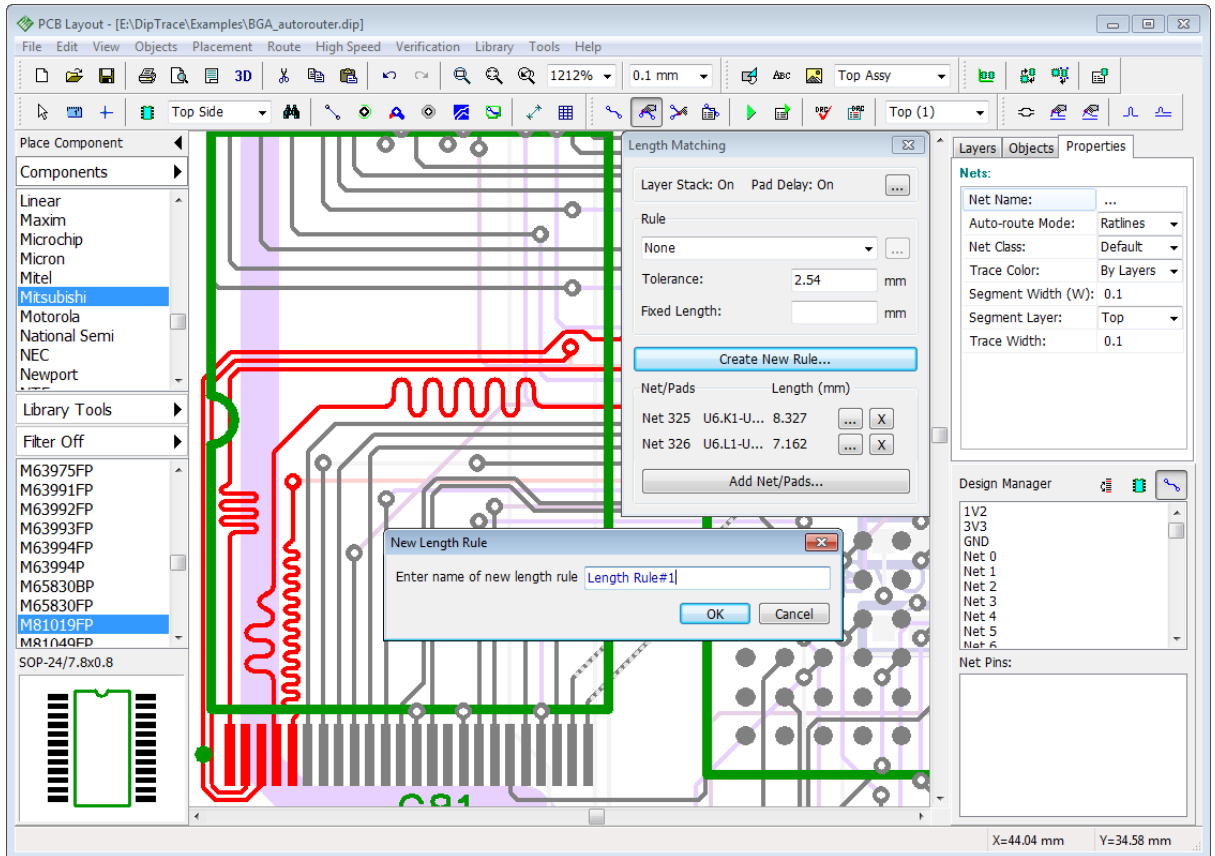

Press **OK** to create a rule.

You can also add new nets to the comparison with **Add Net/Pads** button.

If you work with nets that have more than two pads each, press a corresponding **...** button next to the net to length match only certain track of the net (trace between two pads) or to replace selected net. Press **X** to delete net from the rule.

## 5.6.2 Signal delay

Bond wires are the wires inside electronic component's package that connect pads to the die. These wires introduce a signal delay, which should be accounted for in high-speed designs. Manufacturers report this in-device pad signal delay in the datasheets in picosecond time or as a length.

Pad signal delay value is considered for phase tuning and trace length matching and is added to the total length of the traces. We recommend setting up signal delays when designing a component in the DipTrace Component Editor, but you can also set delays in the Schematic and directly in the PCB Layout.

To set pad signal delay in the PCB Layout, right-click on the component and select **Pad Signal Delay** from the submenu or right-click on the pad and select **Signal Delay**. Select the pad from the list (if not selected already), and enter a signal delay in mm, mils, or inches right below (use **Shift + U** hotkeys to change the measurement units on the go).

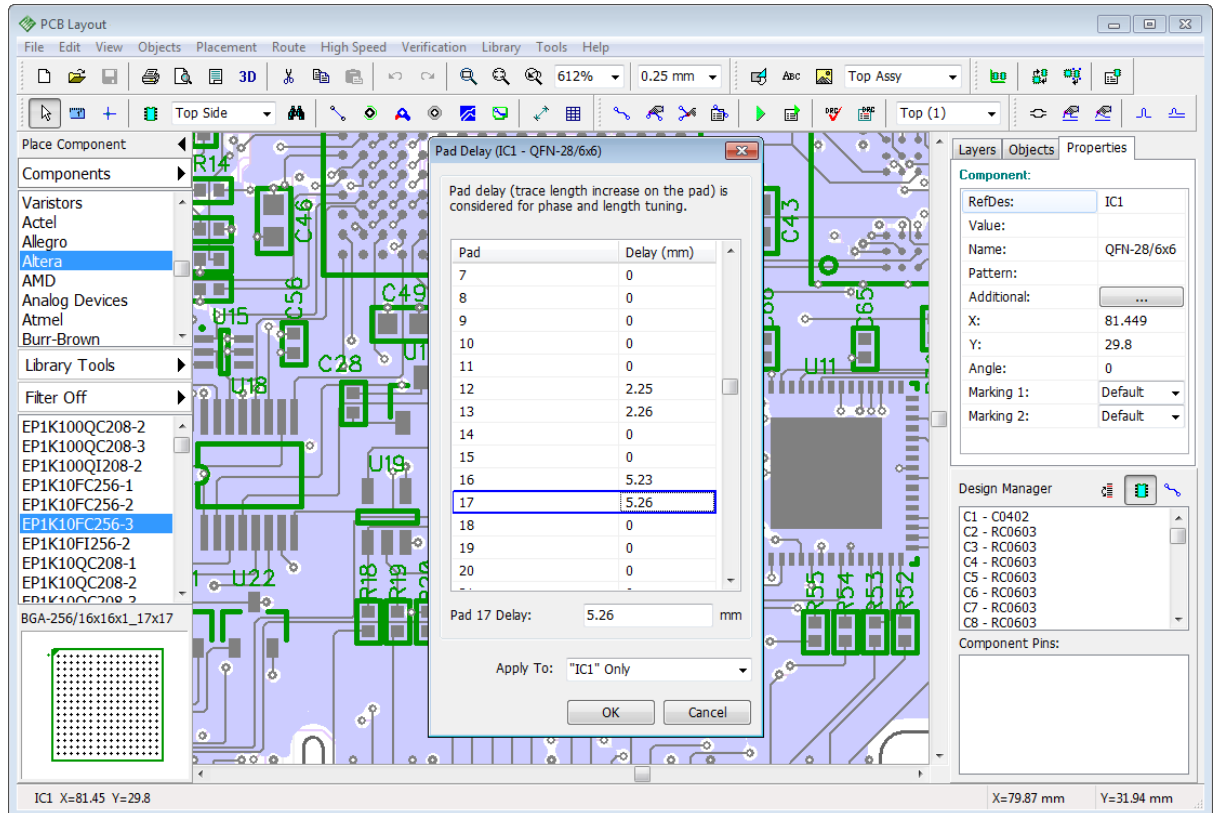

Select if you want to apply signal delay parameter only to the selected component or to all components with the same name on the circuit board. Press **OK** to apply changes. If DipTrace is not using Pad Signal Delay value for trace length and phase calculation, it drops a warning message that suggests you apply pad signal delay values to trace length calculation, press **Yes** in the Warning dialog box.

You can turn ON/OFF the considering of pad signal delay for trace length calculation, just go to "High Speed \ Length Matching" from the main menu, press  button at the top of the pop-up **Length Matching** dialog box and check/uncheck **Enable Pad Delay** item.

### 5.6.3 Create a differential pair

Differential pair signaling is a method of transmitting high-frequency signals using two tightly coupled tracks on the circuit board. One track carries the signal and the other one carries an equal but opposite image of the same signal. Differential pairs are EMI immune, they generate less noise than single-track connections and, basically, are the only acceptable way of transmitting information at high speed.

Open DipTrace Schematic, and go to "Objects \ Net Classes" from the main menu. In DipTrace, all differential pair parameters are governed by net classes, and the program does not allow the user to create differential pairs outside of them. We need to create a new special-type net class for differential pairs. Press **Add** button in the **Net Classes** dialog box, then type in the name of the net class (for example, "Diff\_Class\_1"), and change **Type** to **Differential Pair**. Now you can enter specific differential pair routing parameters.

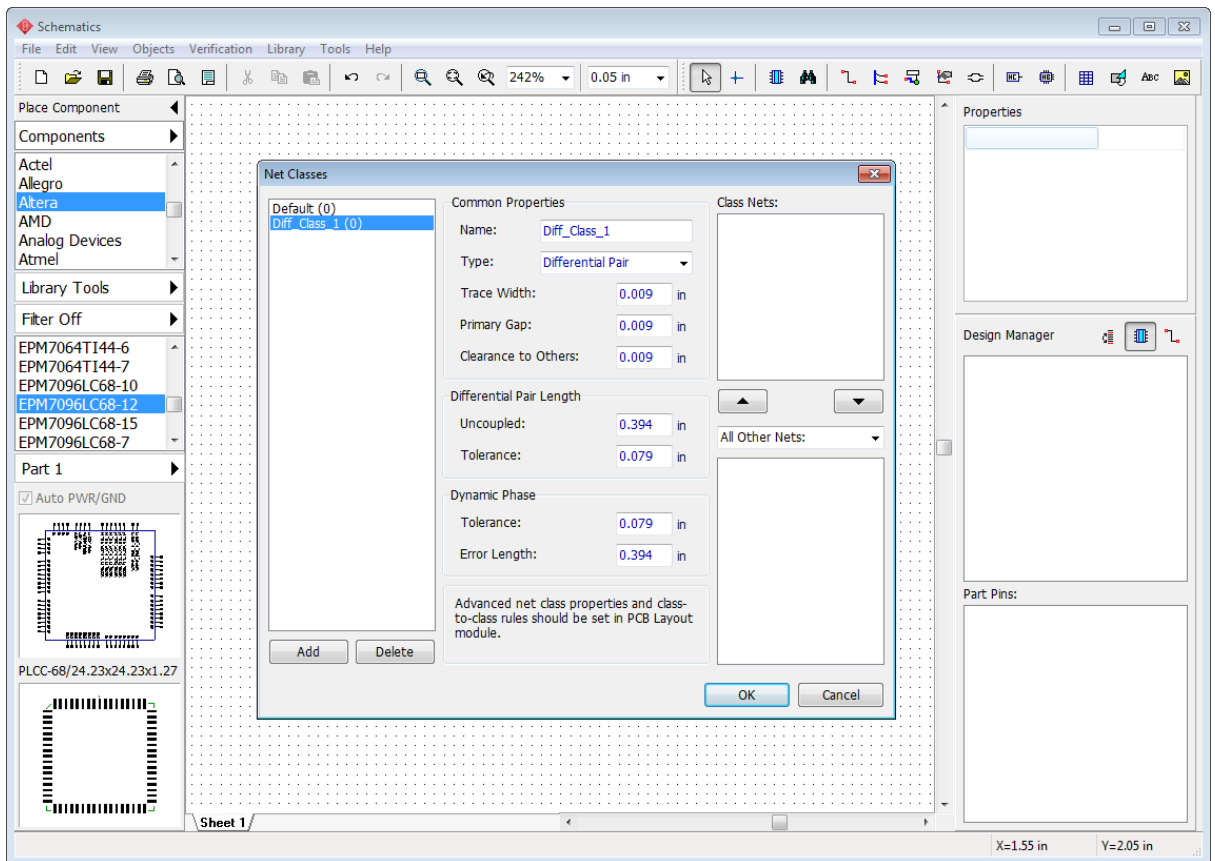



Enter the trace width for tracks of the pair, the primary gap between the tracks, and clearance to other objects on the PCB (for example, 0.009 inch, like in the picture above). You can leave default values in other fields. Notice that the net class is empty (because the design is empty itself).

Press **OK** to close the **Net Classes** dialog box and apply changes.

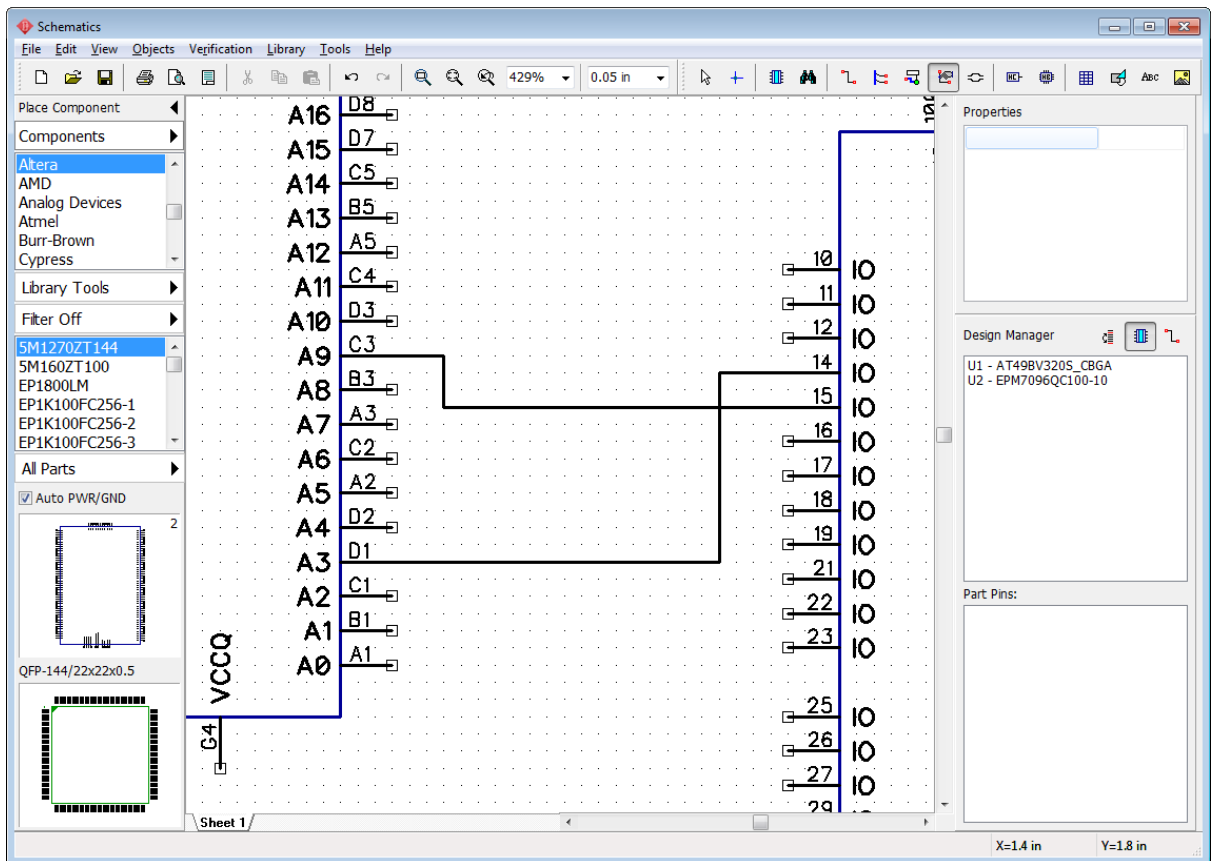
Now we need to populate our schematic with components of your choice for practicing with differential pairs. We have Atmel AT49BV320S flash memory module and a bit obsolete Altera EPM7096QC100-10 CPLD chip on the design area, but differential pair declaration can be assigned to any nets between any components. Create two nets which will eventually become a differential pair. For example, we have the Net 0 connecting the A3/D1 pin of the flash memory to pin#14 of the CPLD-component of and Net 1 – connecting A9/C3 to pin#15.



Now press  button or select "Objects \ High Speed \ Define Differential Pair" from the main menu. In the pop-up dialog box, specify the positive and negative net of the differential pair. For example, we select **Net 0** in the **Positive Net** drop-down and **Net 1** in the **Negative Net** drop-down. You can also pinpoint nets directly on the design area by pressing  or  buttons and left clicking on the nets or their pins.

Since we have only one differential pair net class, the program automatically assigned Diff\_Class\_1 to this differential pair. Net class properties are right below. Press **Edit Net Classes** if you want to open the **Net Classes** dialog box and change differential pair properties.

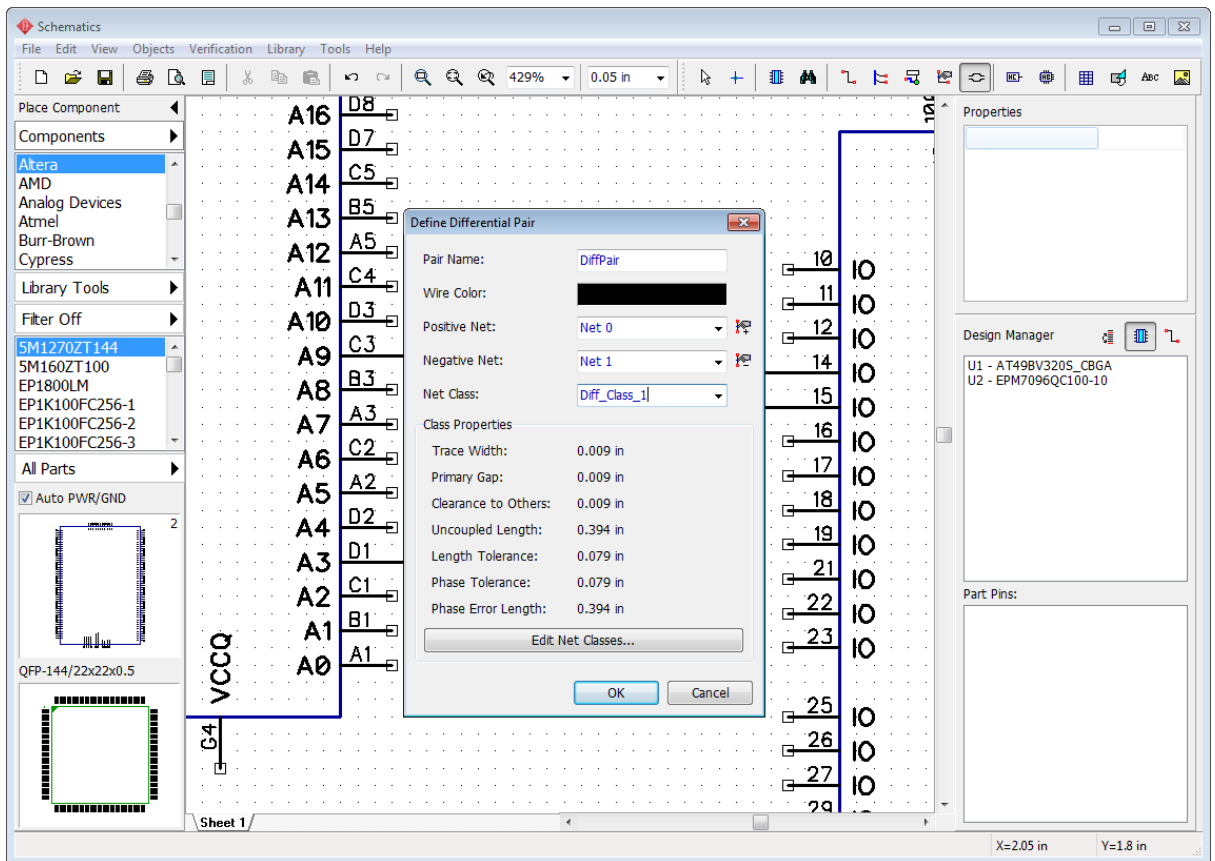

Press **OK**. Net 0 and Net 1 are a differential pair, these nets are renamed to **DiffPair\_P** and **DiffPair\_N** respectively and marked with special symbols on the design area. You can hover over one net with the mouse and the other net of the pair highlights. You can display net names on the design area if you right-click on each net, and select **Display Name** from the drop-down submenu.

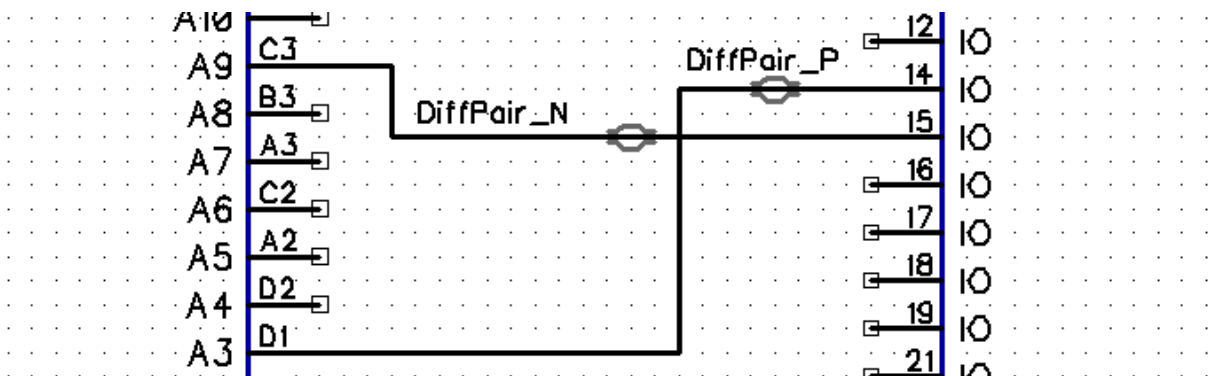

Now let's switch this design to the **PCB Layout** stage and practice more in customizing, routing, and verifying differential pairs. Proceed to the next topic of the tutorial.

#### 5.6.4 Differential pair routing/editing

*Notice that built-in DipTrace autorouter does not support differential pairs. We recommend routing these nets manually or with external autorouters.*

Select "File \ Convert to PCB" from the main menu in the **DipTrace Schematic**, and proceed

with the schematic rules. In the PCB Layout, move components closer together. You can see that differential pair is also marked with a special symbol, like in the schematic. You can see that ratlines are twisted, it's possible to route the differential pair like that, but it would be much easier to rotate the U2 pattern to eliminate the twist. Select the component, and press *R* hotkey two times to rotate the component 180 degrees. Now we're almost ready to start the routing, but, first, we need to go to the Net Classes dialog box to check if we have acceptable routing parameters. Select "Route \ Net Classes" from the main menu, then select **Diff\_Class\_1** net class.

**Differential pair routing parameters.** DipTrace allows the user to specify various differential pair routing parameters. DRC takes these values as routing constraints when verifying the PCB. You can specify the maximum uncoupled length for two traces of the differential pair, length tolerance between the traces, dynamic phase tolerance (length difference between corresponding segments of each track), and phase error length which means that DRC will report any phase shift as an error **only** if it occurs on the track segment longer than the Error Length value. Let's change the **Dynamic Phase Error Length** to **0.3** inch. Leave default values in other fields.

Since we have some small-pitch BGA footprints on the board, we can estimate that our differential pair with 0.009 inch wide tracks, gap and clearance is too big to be routed. DipTrace allows the user to define neck parameters which can be easily applied to differential pairs while routing in tight spaces. Press **Neck Parameters** button.

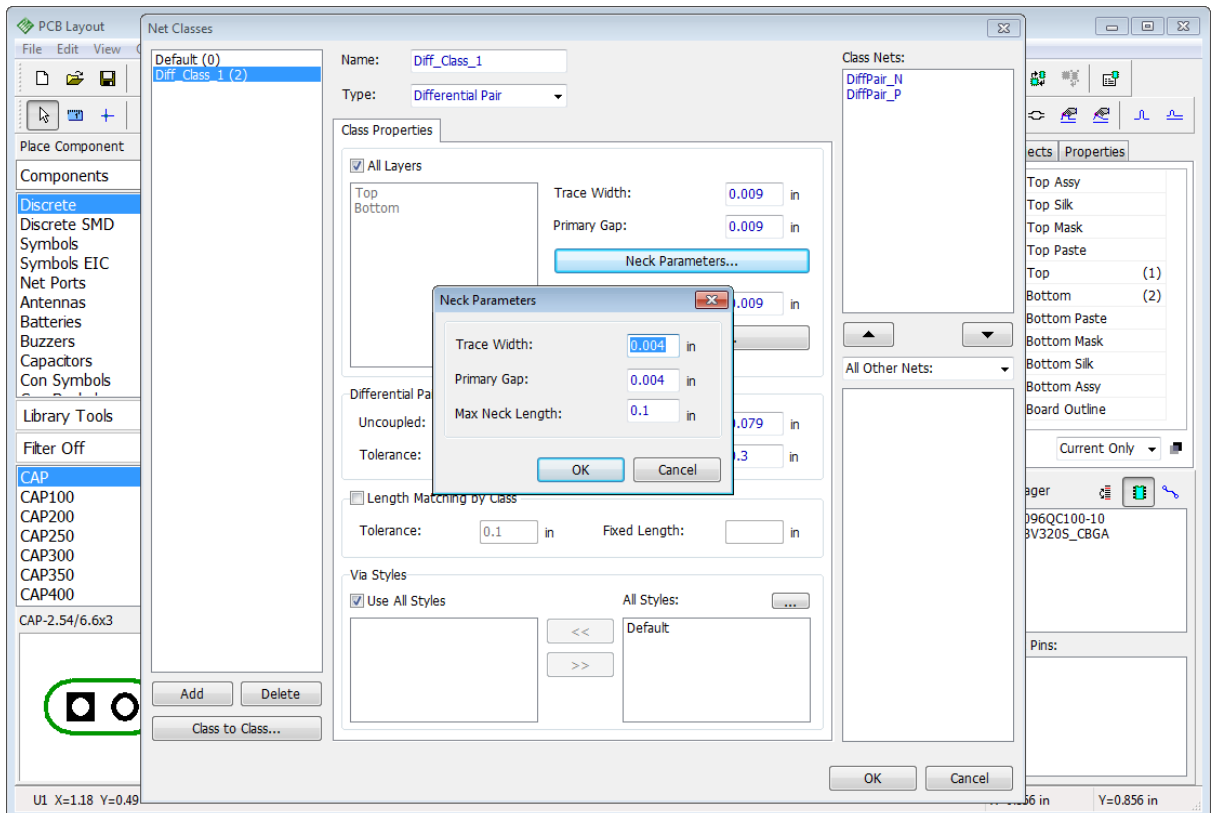



In the small pop-up dialog enter 0.004 inch width and gap, and 0.1 inch as the maximum neck length. This means that necked segment longer than 0.1 inch will be reported as an error by the DRC. Press **OK** to apply neck parameters, and then press **OK** to close the **Net Classes** dialog box.

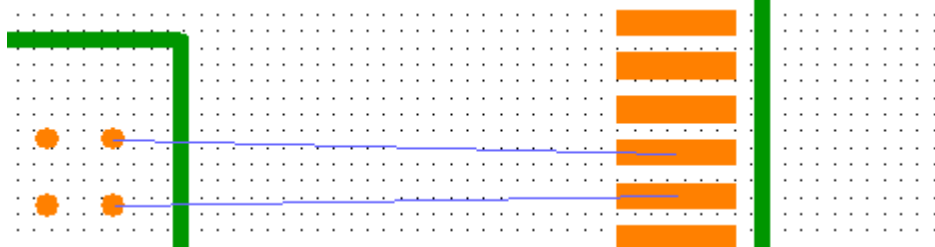

Let's **create one more differential pair directly in the PCB Layout**. First, we need to create a couple more nets with **Place Ratline** tool . For example, like in the picture below.



Then press **Define Differential pair** button () on the High Speed toolbar). **Define Differential Pair** dialog box shows up (this dialog is the same as in the Schematic module), pinpoint the positive and negative nets, change color for convenience (blue in our case,) and apply the same Diff\_Class\_1 net class to this differential pair. Press **OK** and the second differential pair with custom color appears on the design area.

Now press  button on the Route toolbar, or go to "Route \ Manual Routing \ Add Trace" from the main menu, and left-click on any pad of the differential pair – two tracks starts to appear simultaneously. Routing a differential pair is very similar to [routing a single net](#)<sup>[50]</sup>. Ratlines show the direction where to lead the traces. Continue from the U1 component to the U2, and left-click on the corresponding U2 component's pad. The second trace of the pair will be automatically connected to another pad. You can change the routing layer, route mode, current trace segment, and other routing parameters on the **Manual Routing** panel (on the Design Manager), with the corresponding hotkeys (noted in the brackets on the Manual Routing panel) or with the right-click submenu on the go.

If you want to change an active trace of the pair that you route, select **Change Control Trace** from the right-click submenu while routing.

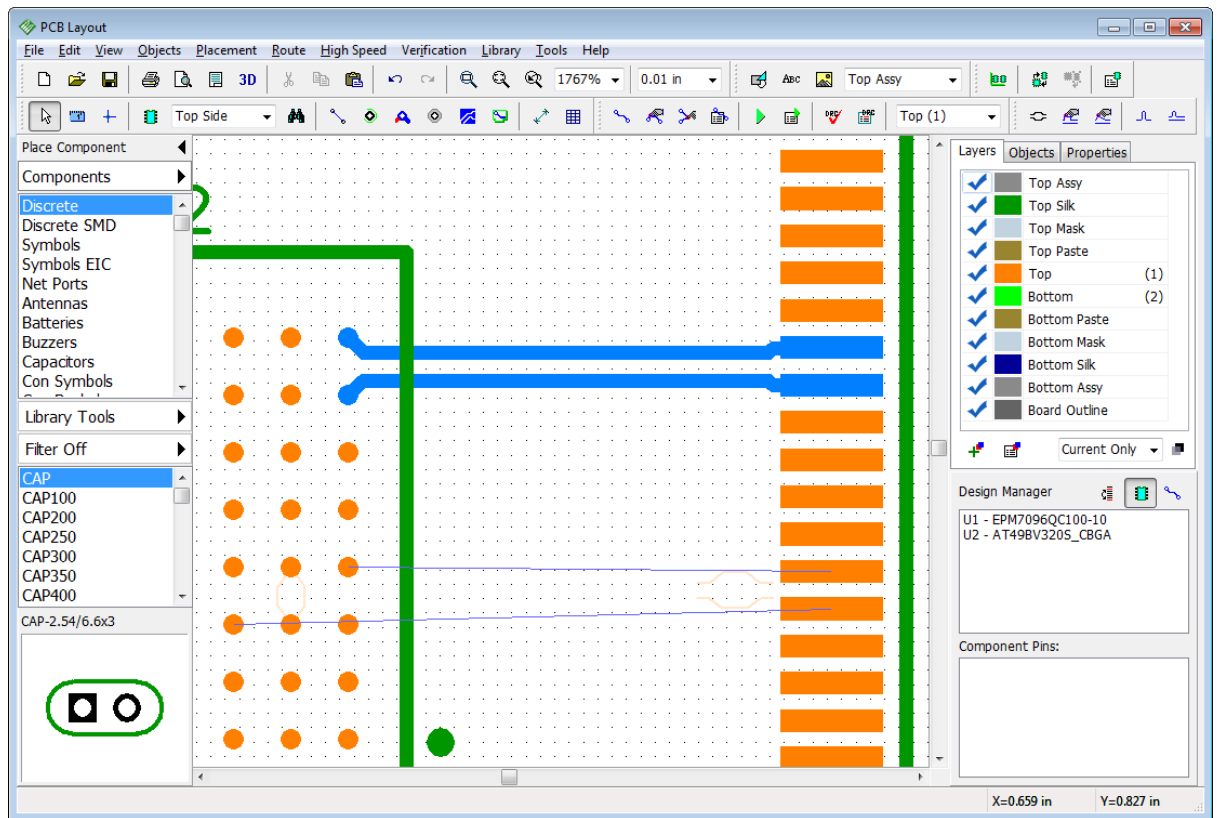

### Single-track routing

In real life, you will often face more complex layout situations. Press  button on the Route toolbar, or go to "Route \ Manual Routing \ Add Trace" from the main menu, then change **Current Segment** to **Free Line** on the **Manual Routing** panel (press S hotkey two times), and start to route the first differential pair from U1 to U2. You will notice that BGA pitch is very small and now is the time to apply the trace necking defined earlier in the Net Class properties. When approaching the U2, left-click to place the trace segments, and then right-click, and select **Neck-down Segment** from the submenu to reduce the width of two tracks and the gap between the traces according to the neck parameters. Left-click again closer to the U2 component to create a small narrow segment (orange traces are routed). Now the tracks are small enough to fit the BGA's pitch, but you still can't finish routing the pair automatically. Hover over the terminal pad to see that the traces offered by the program are unacceptable.

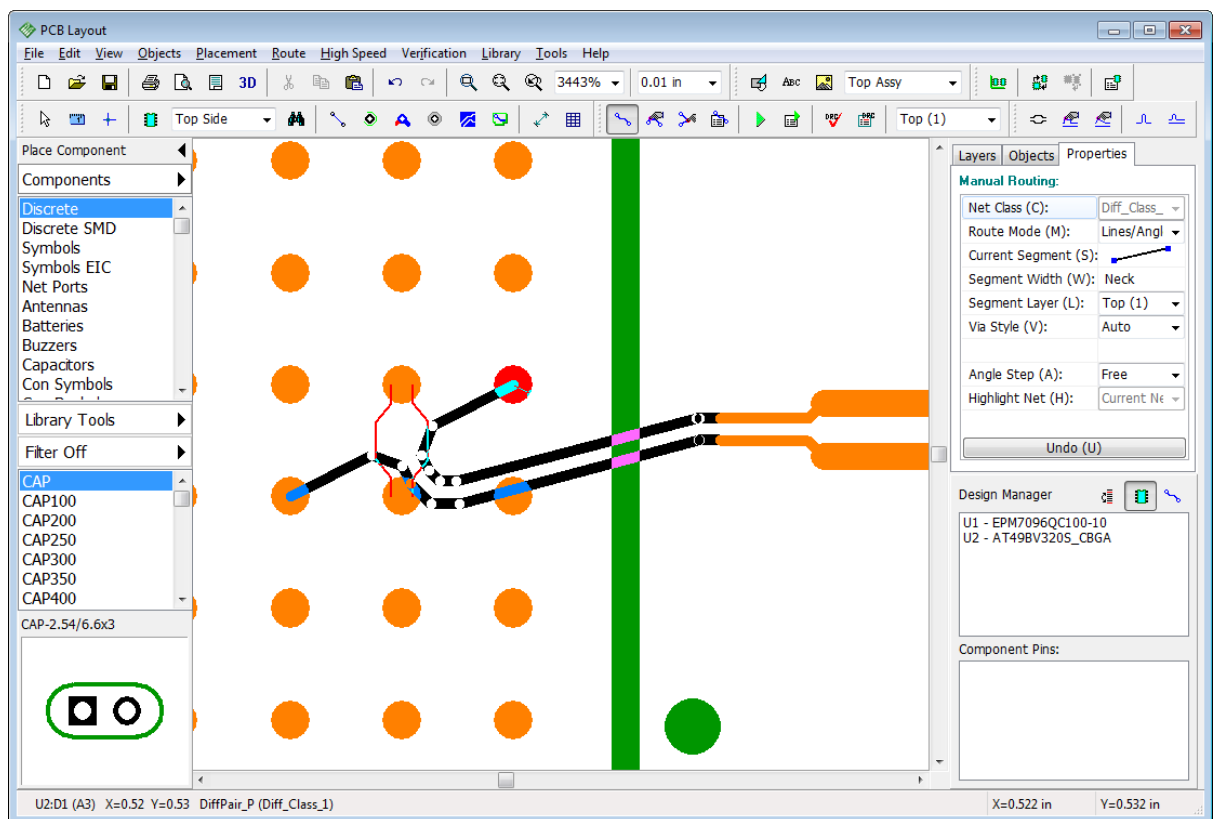

Routing each trace of the differential pair will allow you to succeed in this situation. Right-click, select **Route Single Trace** from the submenu or press Z hotkey, then change current segment to regular lines with a 45-degree angle on the **Manual Routing** panel (or just press S hotkey), then left-click on the terminal pad of the trace. DipTrace will switch to the second trace of the pair for routing. Left-click on the second pad to complete the differential pair.

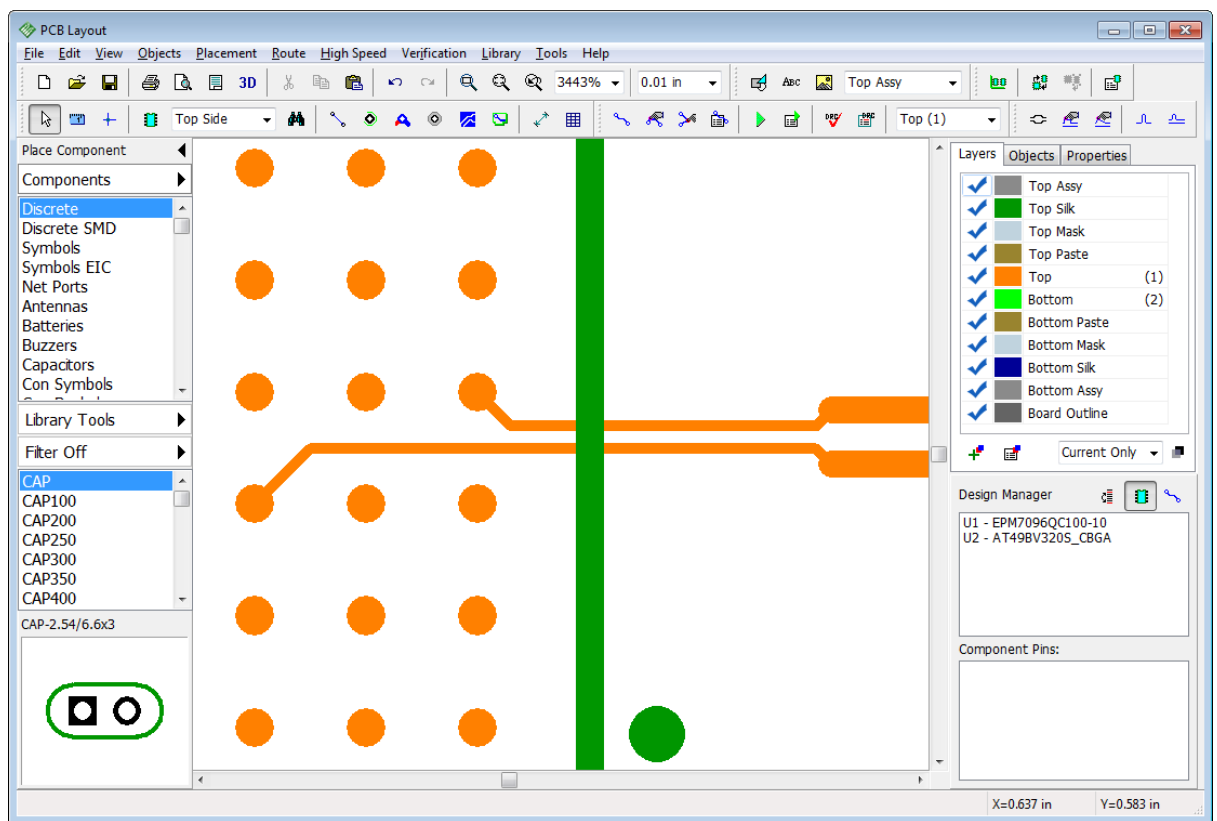

If you want to change the trace of the pair that you route, select **Change Control Trace** from the right-click submenu.

### Controlling the trace length

Controlling the total length of each trace is very important for successful high-speed routing. Right-click on any trace of the differential pair, and select **Show Trace Length** from the submenu, the total length of each track of the differential pair will appear right next to the pads of the differential pair in the current measurement units. To hide the trace length, select the same item from the same right-click submenu again. In our case, the trace length is hidden to keep design more empty and easy-to-understand.

### Edit differential pairs

Right-click on the differential pair, and select a required action from the submenu. You can unroute tracks or separate segments, change a color of the differential pair, the layer of the traces or segments, delete differential pair declaration from the nets, remove necking, and much more. There are two distinct editing modes applied to differential pairs: regular editing

and single track editing. Each one can be in a regular or free style. For example, press  button on the Route toolbar, then drag and drop differential pair's traces to another location. Notice that two tracks move respecting the differential pair gap. You can also use the Free

edit tool (  button) in some situations.

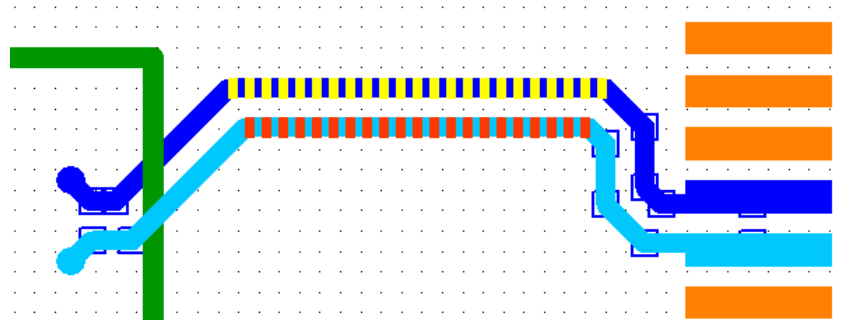

The other mode is similar to single-track routing because it allows the designer to edit each trace of the differential pair separately from the other. Press  button on the High Speed toolbar, and move one track of the pair further away.

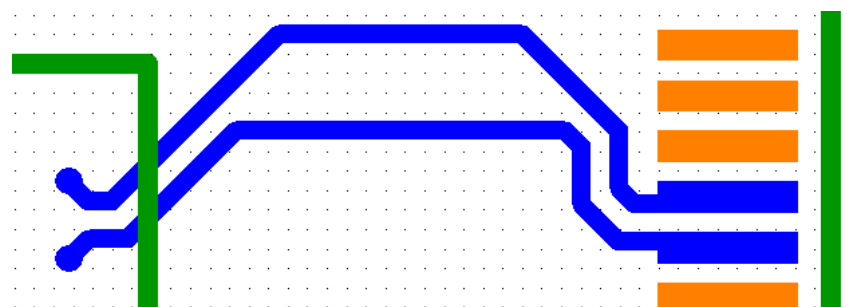

**Single-track free edit mode** (  button on the High Speed toolbar) behaves in a similar way to the regular Free edit mode but applies only to one trace of the pair. You can practice more with differential pairs and change the layer of the trace segment. Right-click on the longest differential pair's segment, and select "Segment Layer \ Bottom". Two traces will move to the bottom layer. Vias will appear automatically.

Please **undo** the last changes to return the blue differential pair to its initial state, then proceed to the topic below for Differential Pair verification.

### 5.6.5 Phase tuning a differential pair

In our case we have Real-time DRC OFF, this is why we do not see any errors on the design area. [Turn it ON, and launch the DRC](#)<sup>[73]</sup> in the regular mode to see the error-report dialog box. DRC checks all clearances and sizes against the target values defined in the "Verification \ Design Rules" main menu item. DRC also takes differential pair properties from the Net Classes dialog box as design constraints. In our case, we have three errors related to the differential pair. When you click on the error in the list, you see the description of each violation, including current and target values. **Rule Details** section right below the list shows where you can change the target values.

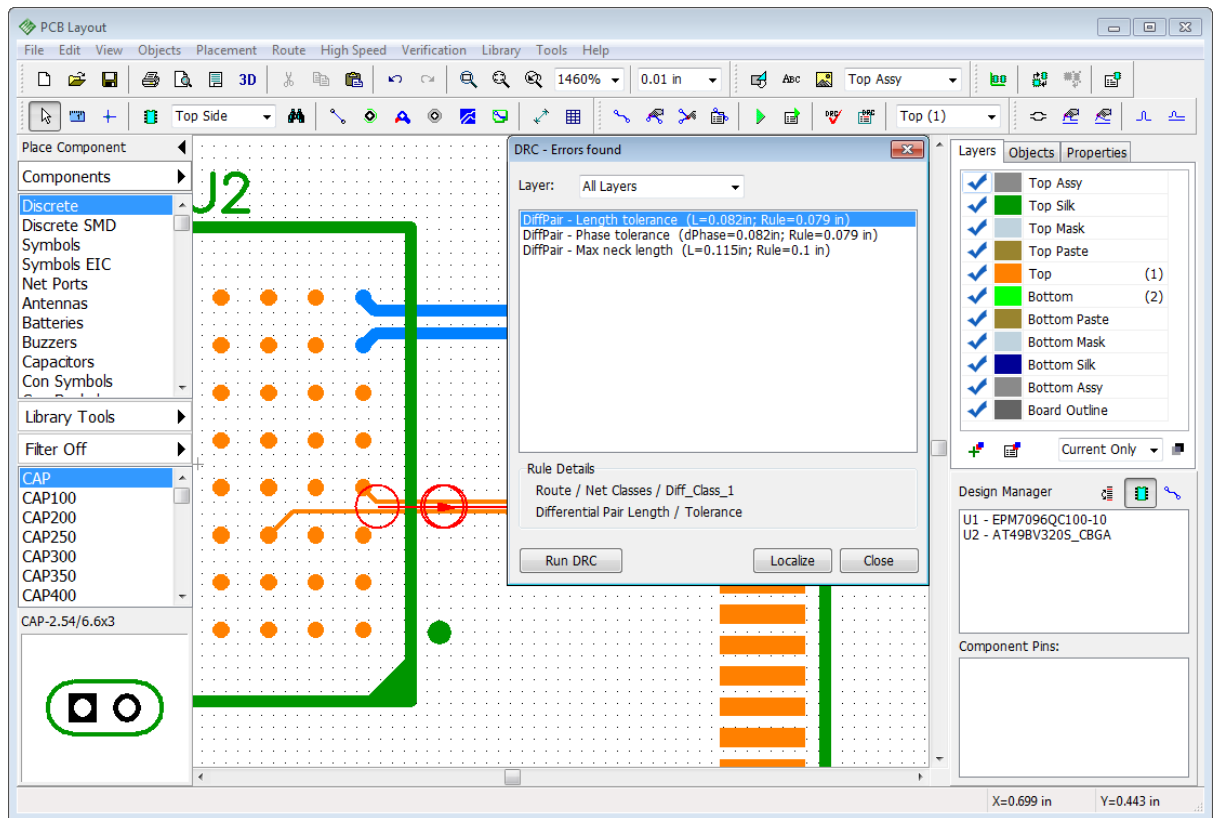

Move the DRC Error-report dialog box a bit, so it does not obstruct the view over the design area, and start fixing the errors. First of all, let's make the necked differential pair segment a bit shorter, as we can see only 0.1 inch is allowed by the necking constraint in the differential

pair net class. Press the **Edit Traces**  button on the Route toolbar, then hover over the place where traces become narrow, the mouse cursor should appear as a left-right arrow parallel to the traces. Now drag and drop the wide trace segments closer to the terminal pads to make the necked traces shorter, like in the picture below. You can apply single-trace

editing tool (  button on the High Speed toolbar), if you can't succeed without an error while moving two traces simultaneously.

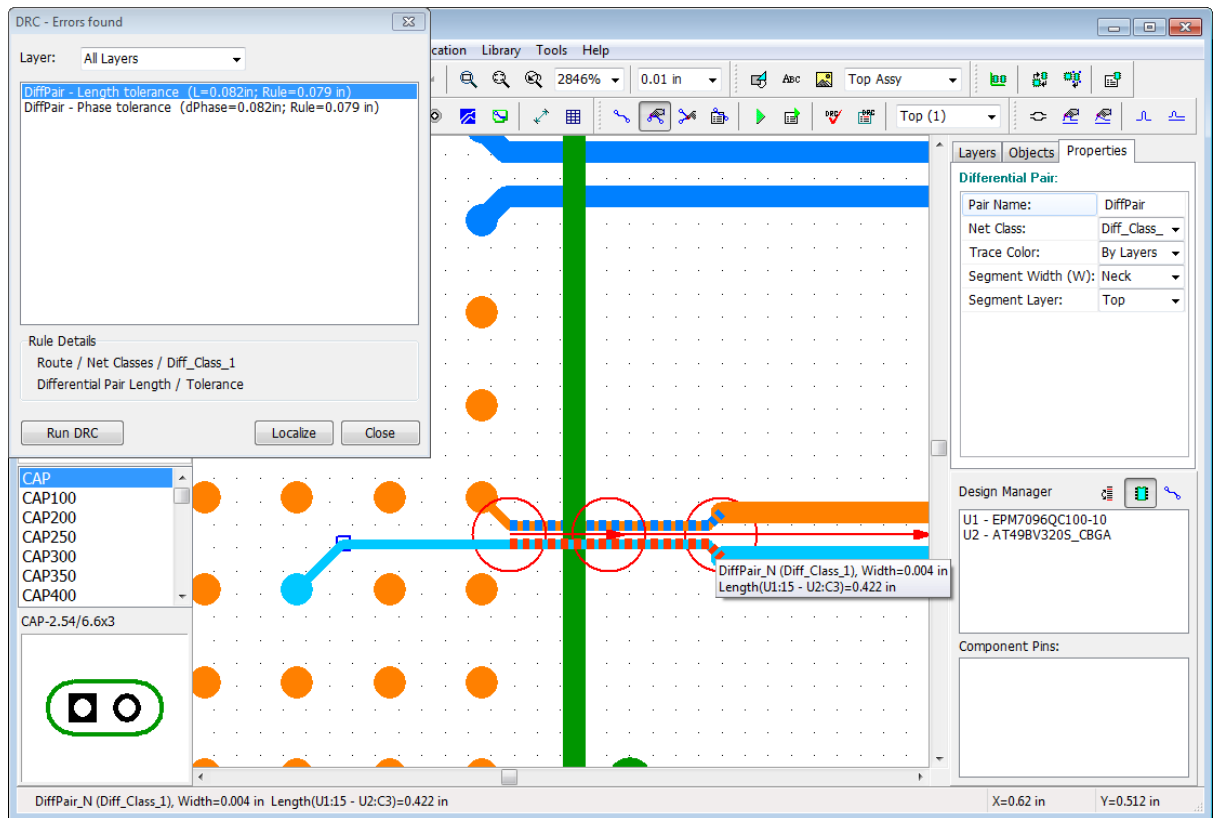

Now only two errors left. The first error says that one trace is much longer than the other, the second error reports that we have phase tolerance violation and it happened on the trace segment that is longer than Dynamic Phase Error Length value in the Net Class parameters. We need to make the shorter trace a bit longer to fix the phase shift. Since our differential pair is almost the straight line, there is a chance that we can fix both errors at the same time with

the **Phase Tune** tool. Press  button on the High Speed toolbar or go to "High Speed \ Differential Pair Tools \ Phase Tune" from the main menu. In the pop-up dialog box, you can check which track needs phase tuning. Hover over the bottom track of the differential pair with the mouse cursor and notice that Backward **Point Phase Lead** value is highlighted in red and the software suggests to add or increase the meander at the opposite trace.

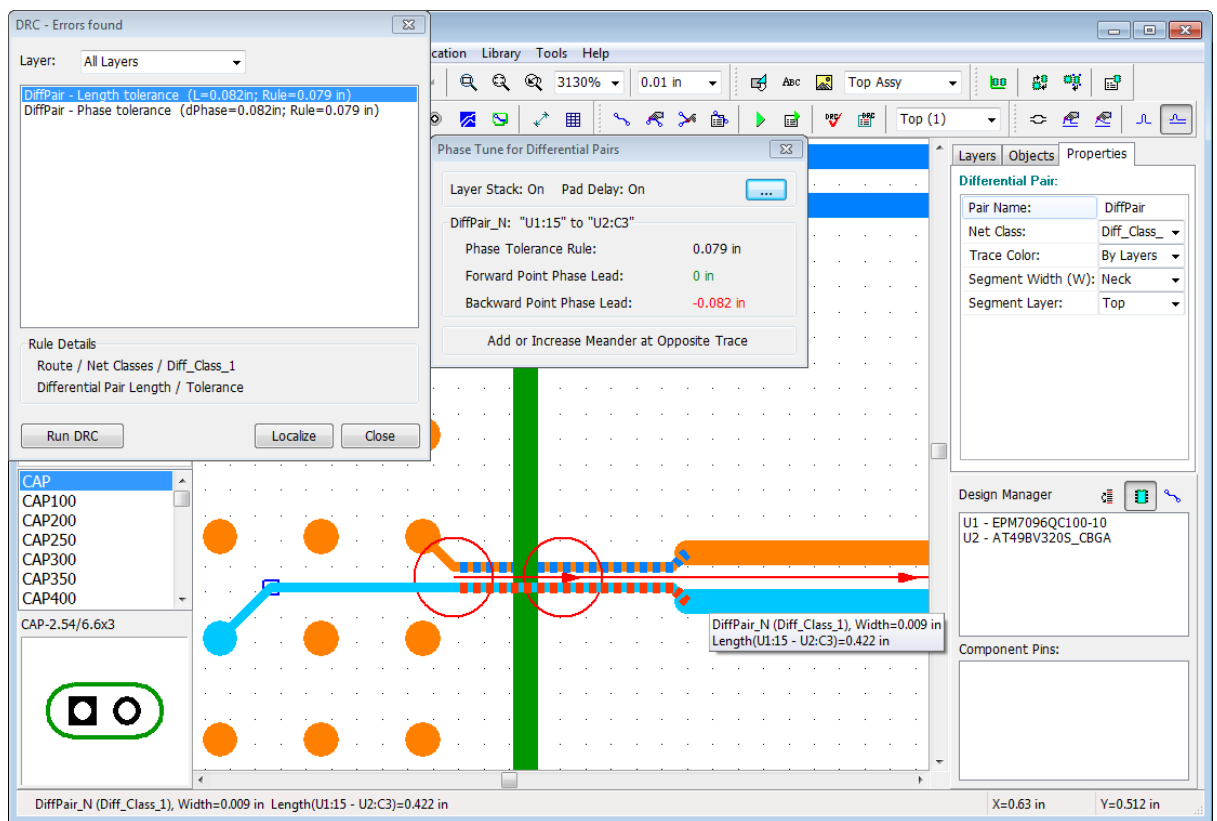



Now hover over the opposite trace. We see that the signal in the upper trace is a bit faster than in the lower one. Left-click on the upper trace, and move the mouse cursor up while holding the left mouse button to create a meander. Release the mouse button when the meander is ready. Because there is a backward point phase lead on this trace, you need to have a meander closer to the U2 component, but not too close to avoid very sharp turns that are bad for the signal. Don't make a meander too big. It has to be just enough to fix the phase shift and not to cause any "uncoupled length" errors.

Press **Run DRC** to check the design again and make sure that all errors are fixed.

You can hover over the small trace segment with the mouse and find out that while the segment closer to the U1 is okay, the segment right next to the U2 component still has a backward point phase lead violation, but DipTrace does not report it as an error, because the segment is shorter than Dynamic Phase Error Length value in the Net Class parameters. This means that we still have a phase shift, but it occurs on a relatively short trace segment well within the tolerance.

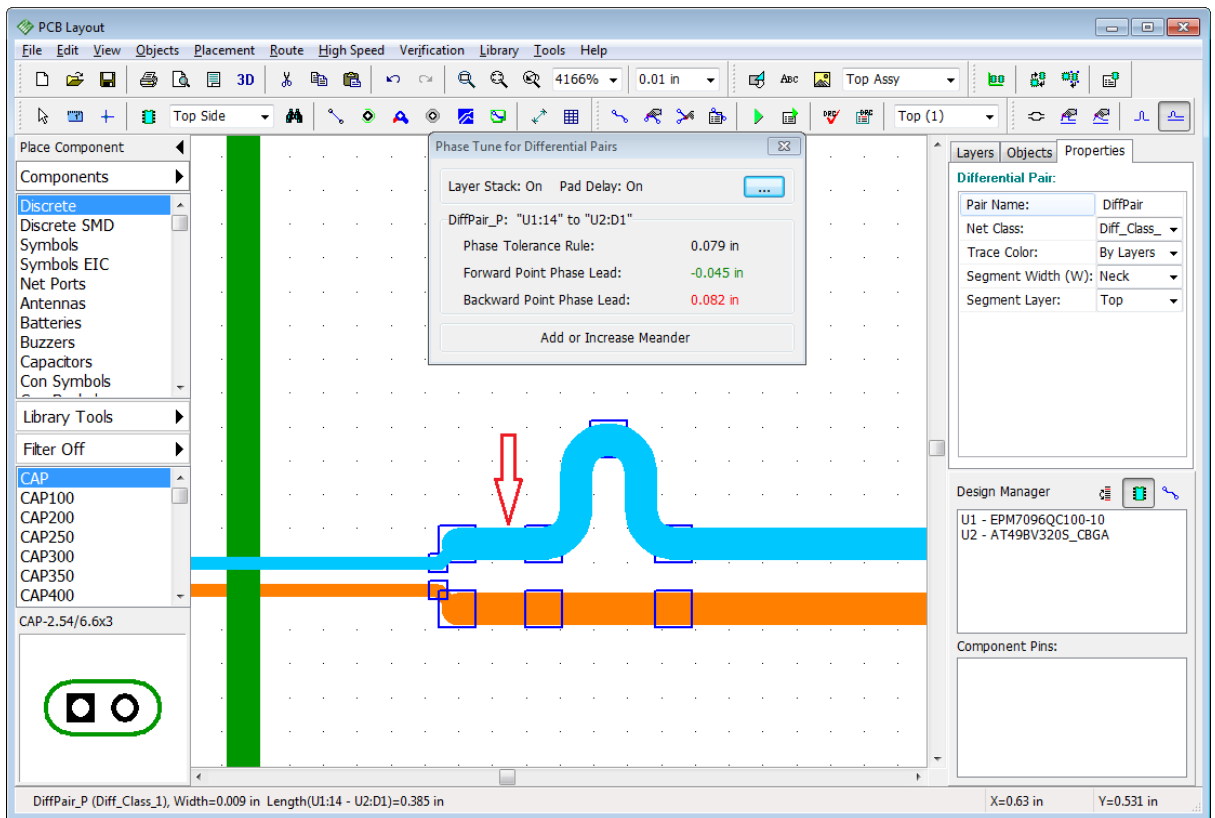



You can edit meander size anytime later, just press the  button on the Route toolbar, and drag and drop the meander's tip.

Notice that DipTrace can calculate a phase shift considering [layer stackup](#)<sup>[182]</sup> (via height) and the length of bonding wires inside a component (determined by the [Signal Delay](#)<sup>[191]</sup>).

By default, DipTrace does not consider these values. If you want to consider them, press the  button in the **Phase Tune for Differential Pairs** dialog box, and check the corresponding items in the pop-up dialog box. However, this is not important in our case, because there are no differential pairs crossing the layers in our design.

### 5.6.6 Differential Pair Manager

If you have a complex design with lots of differential pairs, it becomes hard to manage them directly on the design area. DipTrace has Differential Pair Manager which allows for easy managing/editing/deleting differential pairs. Select "High Speed \ Differential Pair Manager" from the main menu. In the pop-up dialog box, set specific net class in the **Net Class drop-down** to display only the pairs of the net class, or select **All Classes** to show all pairs of the design in the list right below. However, this does not make any difference in our case, because we have only two differential pairs of the same net class.

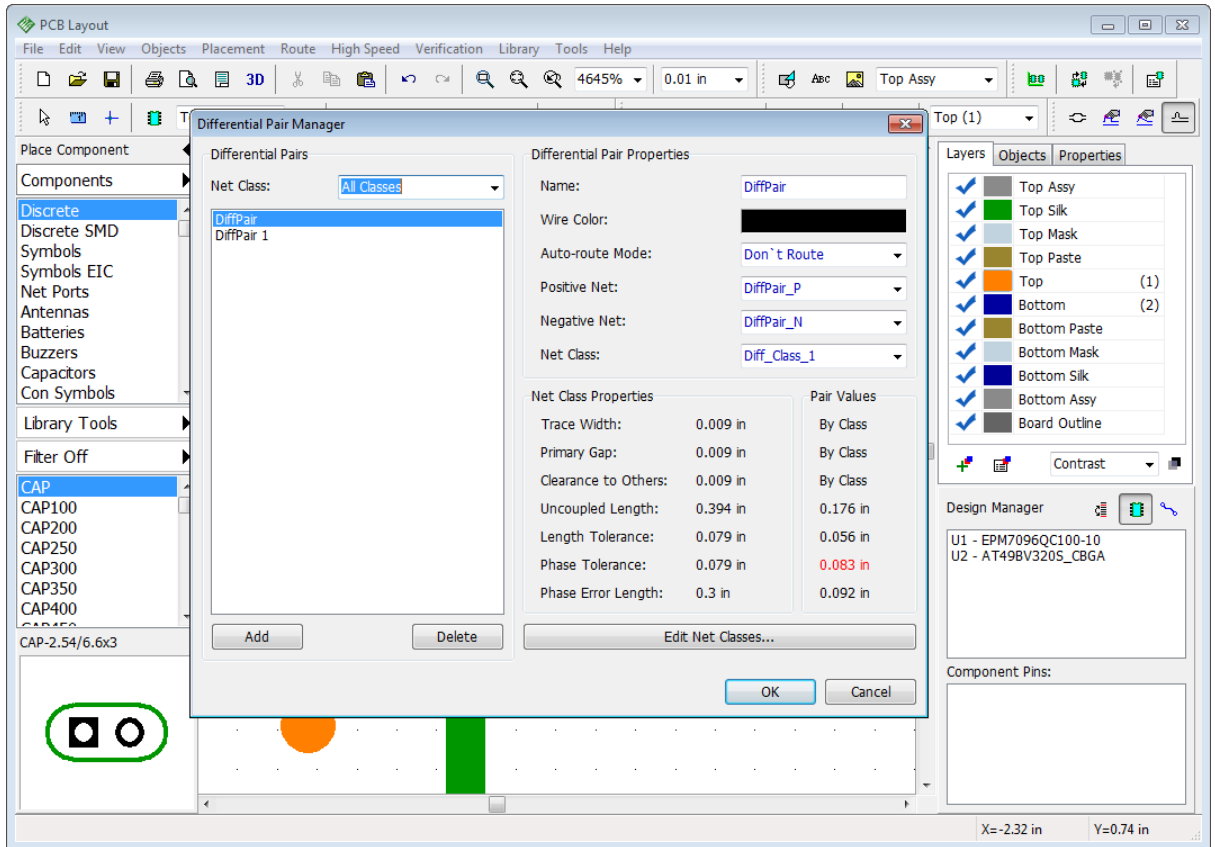

Press **Add** to open **Define Differential Pair** dialog box and create a new differential pair, or select existing one from the list and modify its name, color, nets, net class, etc. Right below you can see the Class Properties and Pair values if this differential pair is routed. Red-highlighted value is the violation. In our case Phase shift on selected differential pair is bigger than the tolerance, but it is not considered an error unless there is a Phase Error Length violation.

### 5.6.7 Define paired pads

On very rare occasions for the circuit boards with lots of various differential pair pads very close to each other, DipTrace might not be able to draw two traces and finish routing the pair. In this case, you will get a warning message that offers to use **Define Paired Pads** feature.

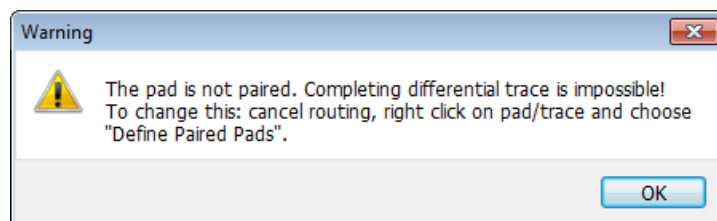

Here is a typical situation. We have R6 and R10 pads that belong to the negative net and R11, R7 pads of the positive net of the differential pair. It is possible that the software in such case can terminate the second trace on the R7 pad (not on the R11), or either drop the warning message.

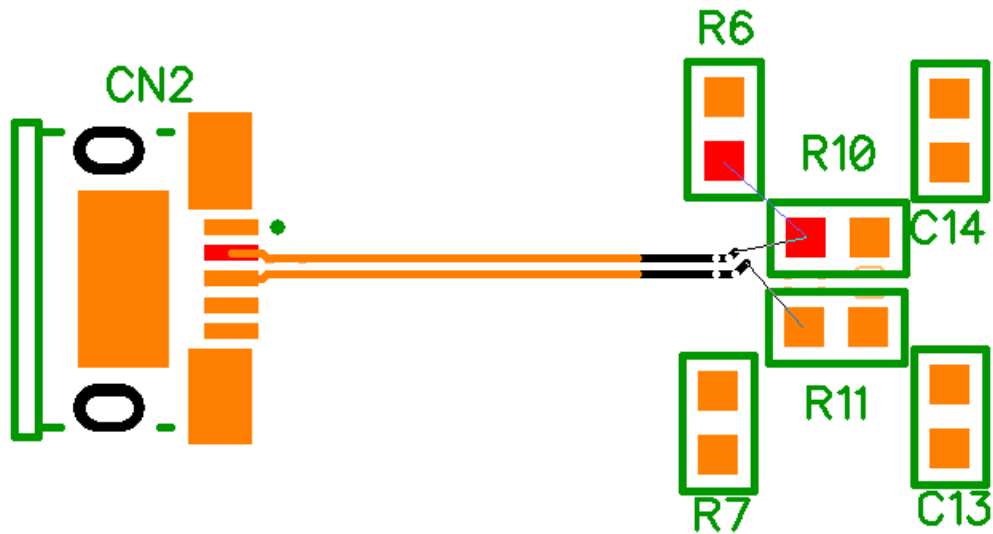

To fix this issue, you need to group the pads. Go to "High Speed \ Define Paired Pads" from the main menu. In the pop-up dialog box use the **Differential Pair** drop-down list to select the pair. You can press **Update** button to let the program find pads automatically, or check **Manually** checkbox and define the pair of pads using the lists right below.

We have one pair of pads on the side of the CN2 connector (CN2:3 and CN2:2). Select R11:2 from the Positive Net list and R10:2 from the Negative Net list, because we want the differential pair to terminate on these pads. Then press the **left arrow button** to add selected pads to the **Paired Pads** list, and press **OK** to apply changes.

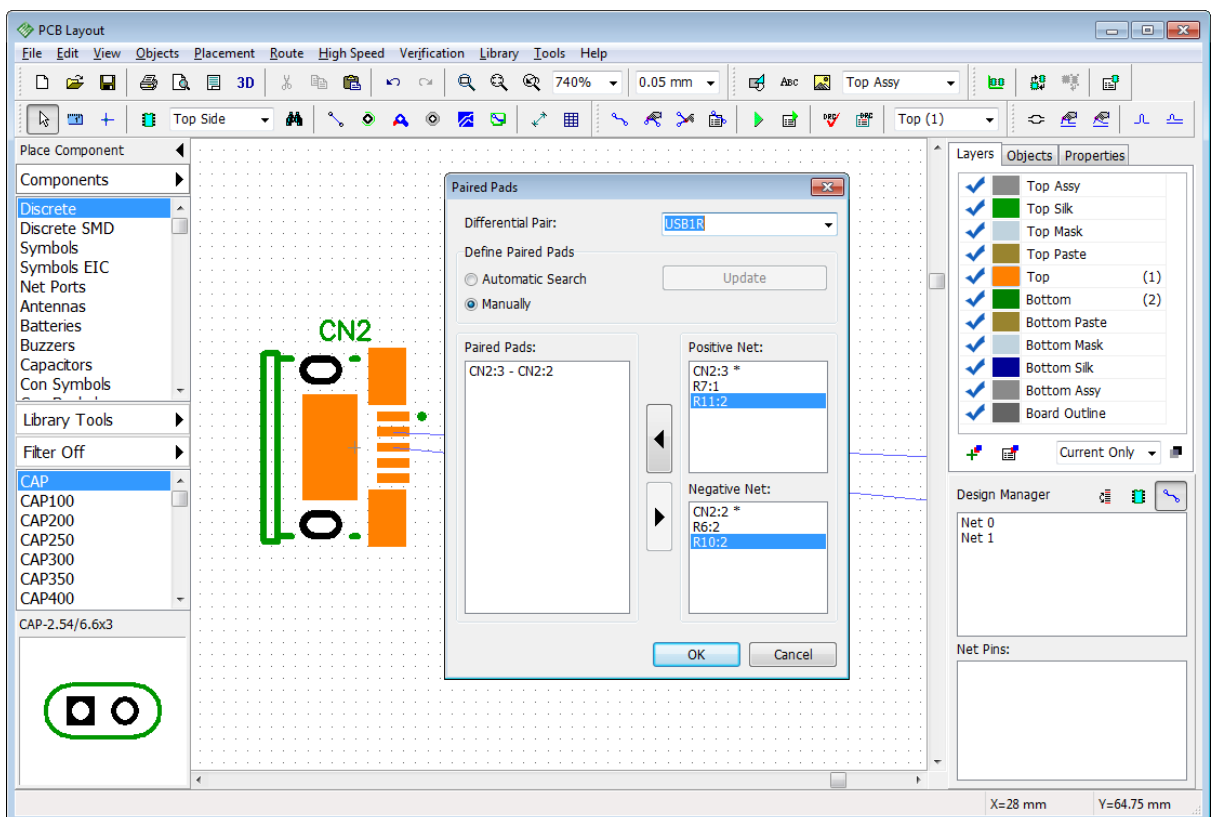

Now route the differential pair. Everything works fine because the software clearly knows

where you want to connect the differential pair nets. Finally, draw two traces from the R6 and R7 pads to their respective nets.

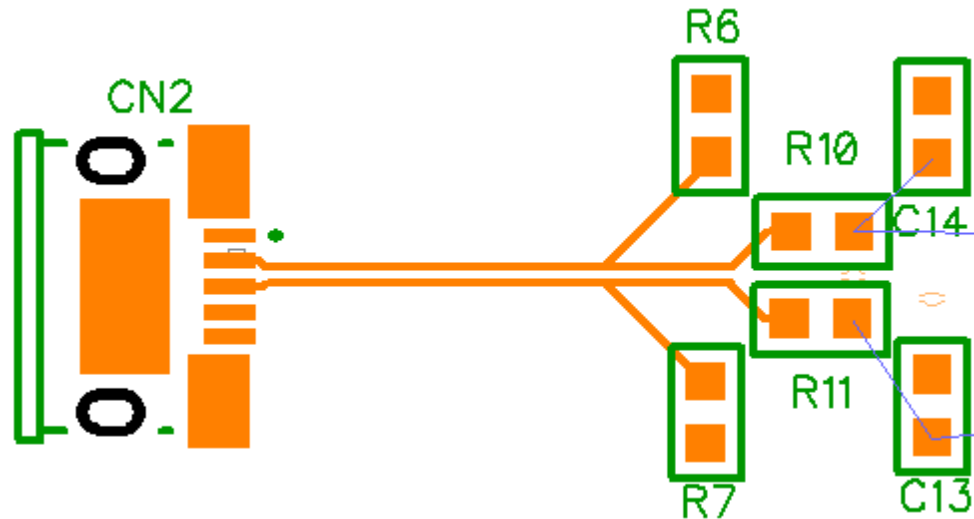

## 5.7 Fanout

Fanout allows the user to automatically connect pads of selected components (BGA, SOIC, QUAD) or SMD pads of selected net to inner plane layers with vias of selected style.

Open the PCB Layout module or if it is already open, select "File \ New" from the main menu. Load rules from the \*.rul file that we created at the end of [Saving/Loading Design Rules](#)<sup>[226]</sup> topic of this tutorial. It should have the default, through-hole, and blind/buried via styles, custom net class, and two inner plane layers.

### Fanout a component

Now select **Patterns** library group, it contains all patterns available in standard DipTrace libraries. Notice that these are just the patterns without schematic symbols. Place one PLCC-20/8.97x8.97x1.27 from the **General** library and two BGA-100/10x10x1.27\_15x15 from the BGA library. We will use these patterns for demonstration, but you can select another patterns/components for practicing with fanout.

Right-click on the PLCC pattern, and select **Fanout** from the submenu. In the pop-up dialog box specify: **Pattern Type: SOIC/QUAD**, **Placement: Outside**, **Pads: Left** (this means that only the left row of the pads will have fanout vias), and make sure that **Use Connected Pads Only** checkbox is unchecked (because we want to have fanout vias for all components pads, regardless of whether they are connected or not).

Select different Via Styles for the pads on the top and bottom side of the board (inactive if there are no pads on that side). Preview parameters of existing via styles by pressing the **Via Styles...** button. In our case we have three via styles: one with through-hole vias, another with blind/buried vias and the Default via style with relatively big vias. Select the one which fits the size of current component (Default via style in our case).

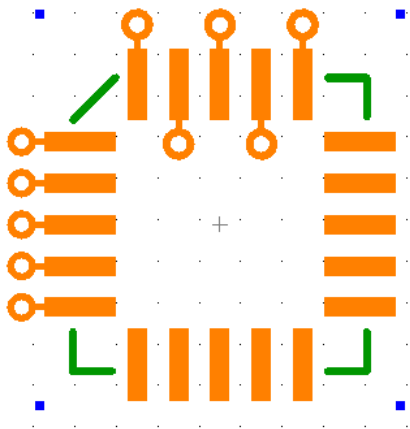
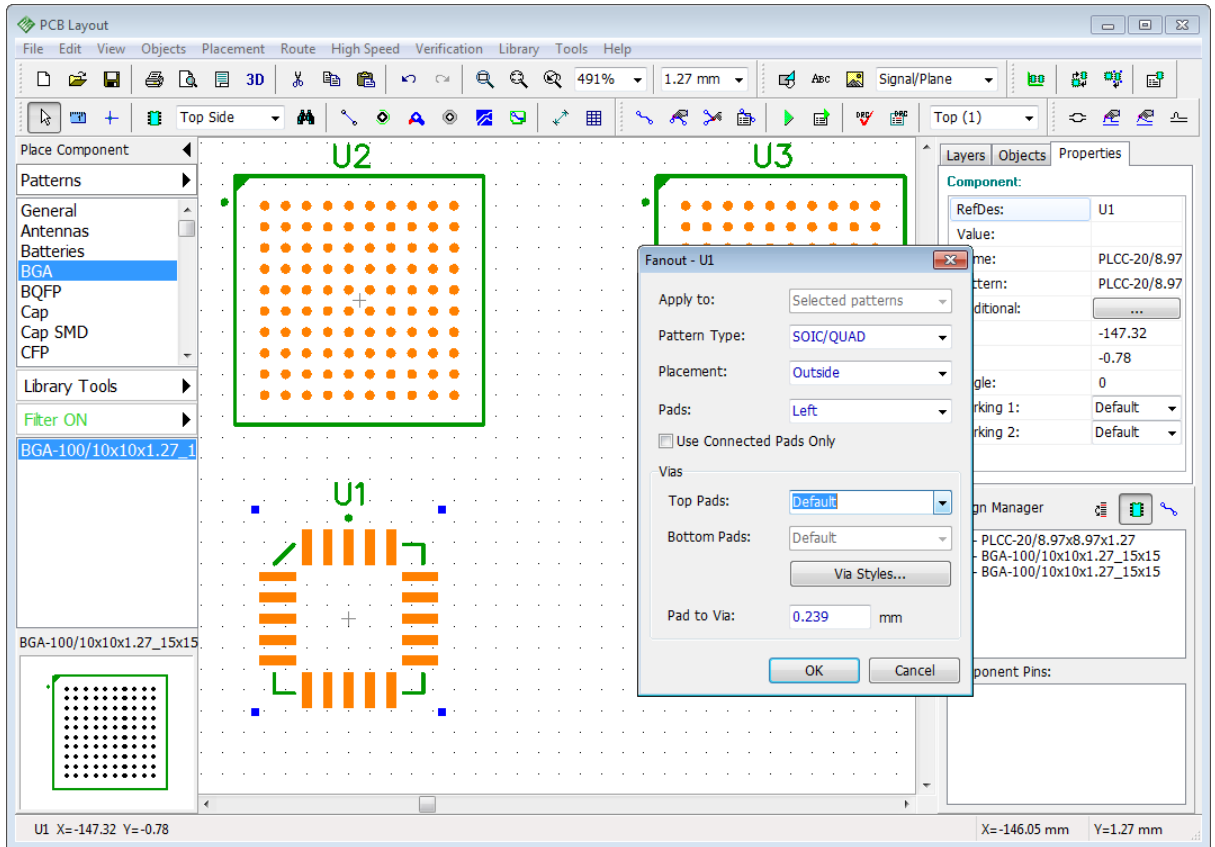

Press **OK**, and vias will appear outside the left pad line of the PLCC pattern. Right-click on the same pattern, and select **Fanout** again. Now we will place zigzag vias for the top pads. Set: **Placement: Zig-zag** and **Pads: Top**, keep other settings, and click **OK**.

Now we will make through-hole vias for one of the BGA patterns and blind/buried vias for another. Make sure that you have the corresponding via styles first. BGAs will need smaller vias (we used 0.5 mm vias with 0.25 mm holes for this example).

Right-click on the first BGA pattern, and select **Fanout** from the submenu, specify **Pattern Type: BGA – All pads** and select custom via style with through-hole vias. Press **OK**.

Now select the second BGA package. Right-click it, and choose **Fanout** from the submenu. Set **Pattern Type: BGA - By rows**. This allows the user to apply different via styles to different pad rows of the same pattern or even exclude some rows from the fanout. Left-click on the row number, and select **Via Style** from the drop-down list.

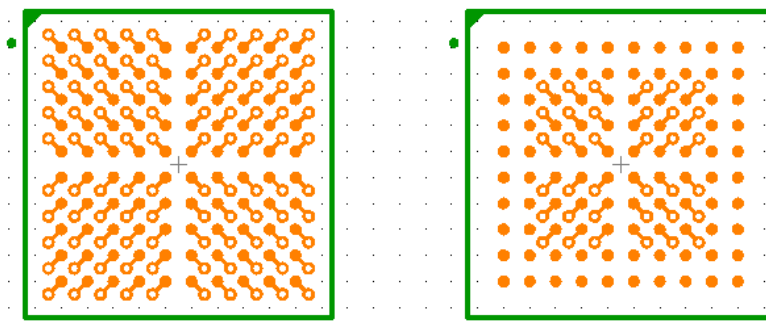
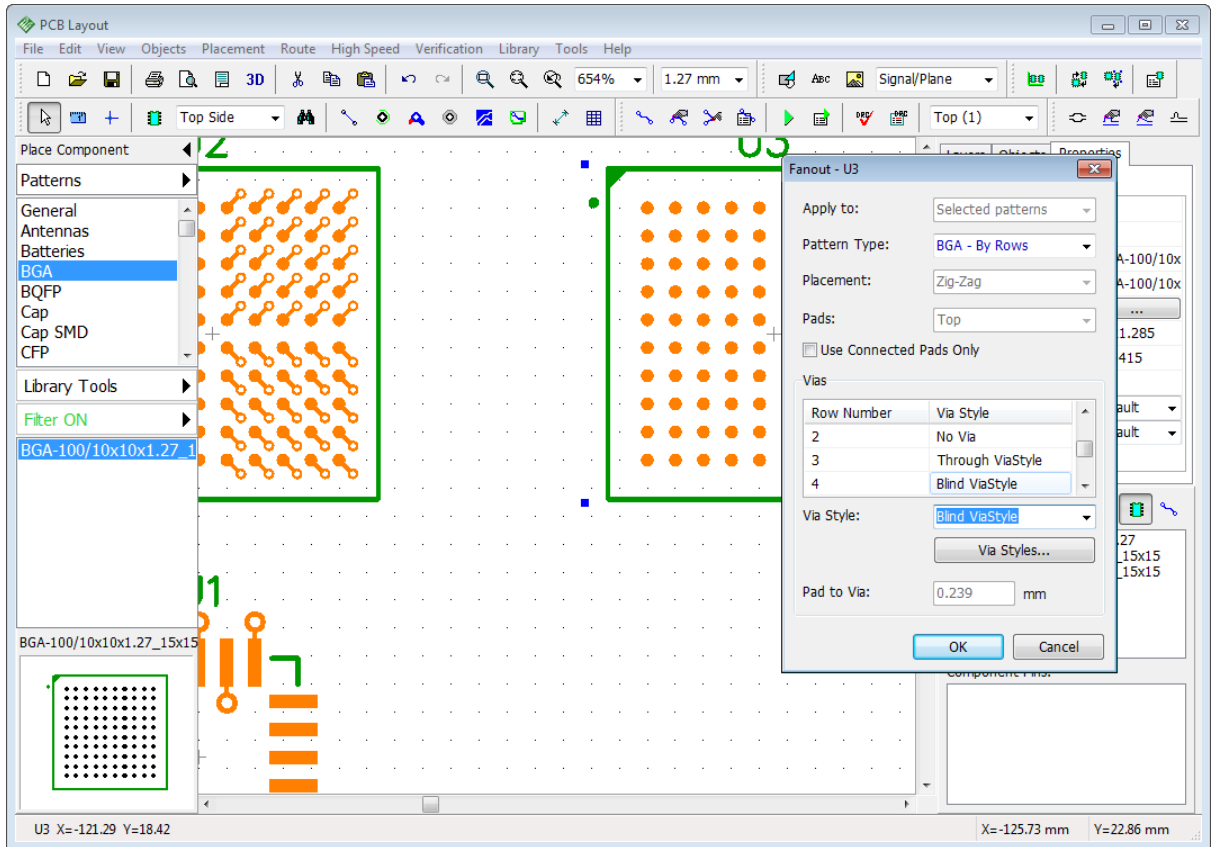

We will not create vias for rows #1 and #2 and use different via styles for different rows. Press **OK**.

We can see, that for the first BGA pattern all pads are connected to vias, for the second pattern – first two rows are without vias,

because these are usually connected on the top layer of the board.

### Fanout net

We will connect several SMD pads to the GND plane layer using the **Fanout** feature. Place several SMD and a couple of through-hole patterns on the design area. Create a net that connects some pins of these components (we suppose this is our GND net that we should connect to the GND plane layer). Select "Objects \ Place Ratline" from the main menu or

press  button on the Objects toolbar to create ratlines (connections). Rename net to "GND" if you want. Check the **Ratlines** item on the Design Manager's **Objects** tab if you don't see the ratlines on the design area.

Make sure that there is a via style with blind/buried vias from Top to GND layer, then right-click on one of the connected pads (not on the pattern), and select **Fanout** from the

submenu. In the pop-up dialog box select appropriate via style, and click **OK**. Now all SMD pads of selected net have vias connecting them to the GND inner plane layer, where we placed a [copper pour](#)<sup>[64]</sup> connected to GND net.

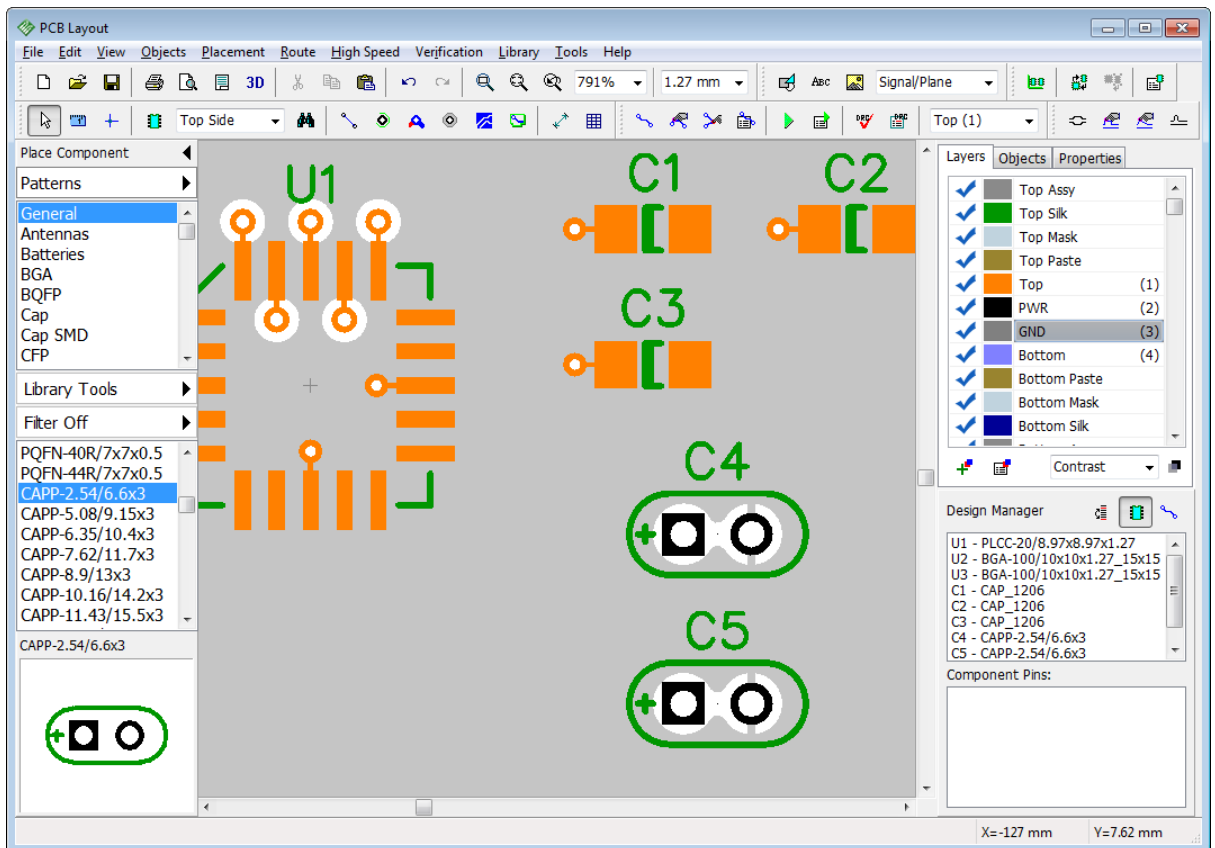

## 5.8 Renew layout by schematic

Sometimes electronic designer needs to make important changes to the circuit board, for example, add new net or component. We always recommend to start implementing those changes in the Schematic, but they do not automatically appear in the PCB Layout, you need to launch **Renew Design from Schematic** to automatically update existing circuit board according to the schematic.

If you made changes in the Schematic and want to bring them to PCB Layout, select "File \ Renew Design from Schematic" from the main menu in **DipTrace PCB Layout**, then select one of available renewing modes:

**1) By components** means using the hidden IDs to determine component-to-pattern links – this mode works only if the circuit was created in DipTrace Schematic. Renewing by components doesn't depend on Reference Designators, therefore, they can differ in the schematic and on the PCB.

**2) By RefDes** means that component-to-pattern links are determined only by Reference Designators. Components must have the same reference designators on the circuit board and in the schematic.

**3) Related Schematic** means renewing by components from a related schematic file (go to "File \ Layout Information" from the main menu if you don't remember the source-schematic file).

Now select the schematic file, and press **Open**. DipTrace will keep component placement and current routing on the circuit board. New components appear near the board outline ready for placement.

## 5.9 Back annotate

Back Annotation allows the user to update schematic according to the PCB file. This feature is useful when you've made changes directly on the circuit board and want to keep the layout and schematic synchronized. Use it with caution, because the Back Annotation, unlike the [Renewing from Schematic](#)<sup>[211]</sup>, has certain limitations.

Launch DipTrace PCB Layout module, then open "PCB\_2.dip" file from the "Examples" folder. Use Design Manager to find C8 and C10 capacitors – double click on the component name in the list to localize and pan design area to selected component. Change the reference designators of C8 and C10 capacitors to C28 and C30 (right-click on the component, and select the first item from the submenu). Select "File \ Save As" and save this PCB in another file, for example, "PCB\_2\_ver1".

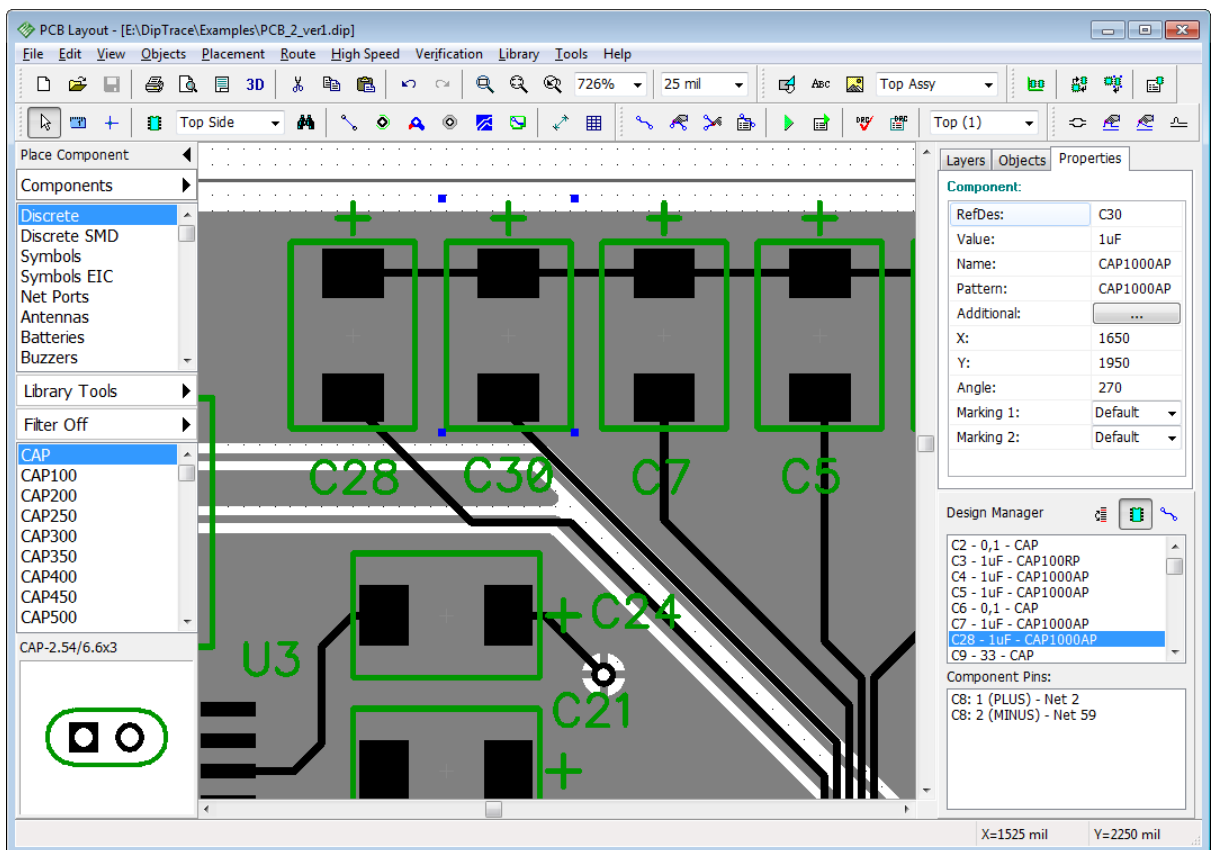

Close the PCB Layout and open Schematic Capture again (notice that you can open it directly from the PCB Layout by selecting "Tools \ Schematic" from the main menu).

Open "Schematic\_2.dch" file and find C8 and C10 components. You can use the Design Manager or press *Ctrl+F*, then type in "C8", and press *Enter* to find the component. C8 capacitor appears highlighted in the center of the screen.



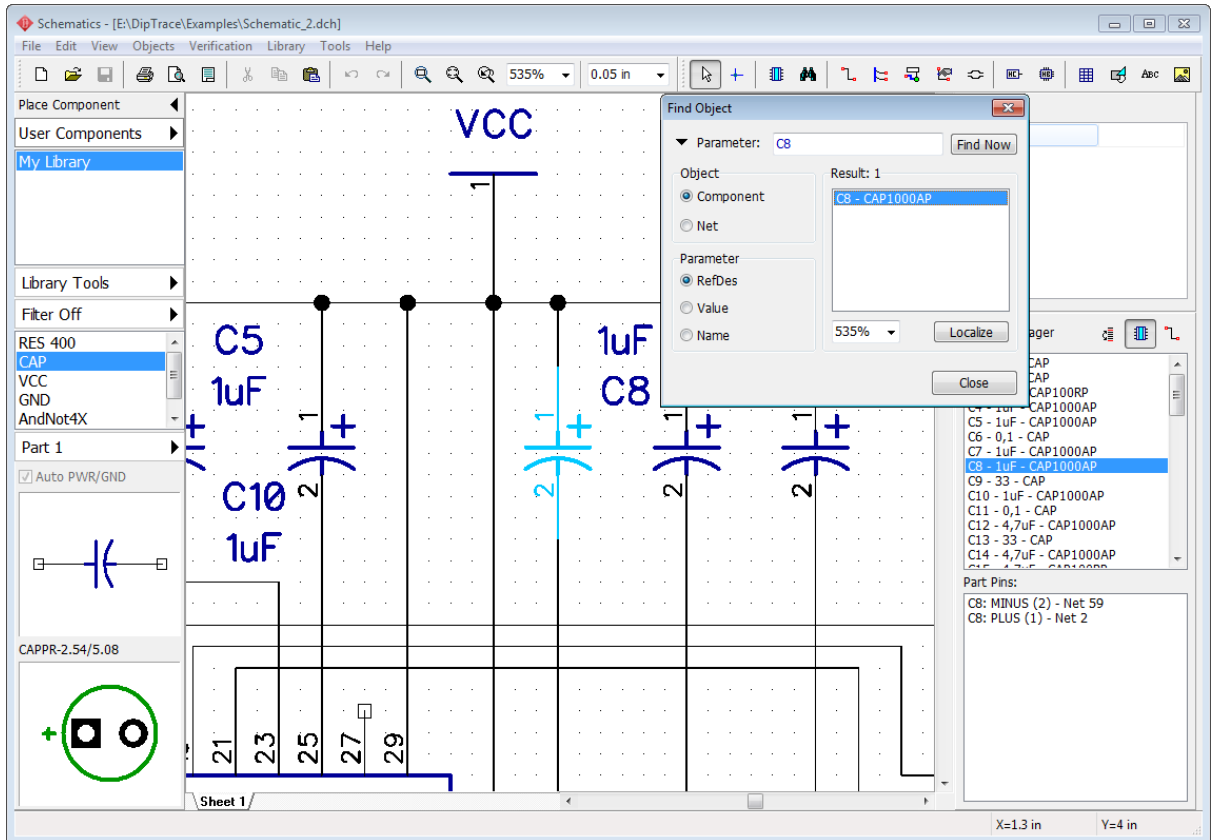

Notice that you can minimize the **Find Object** dialog box by clicking the arrow in its upper-left corner and use this dialog while editing the circuit.

Zoom on the design area to see C8 and C10 components better. PCB\_2 is the circuit board related to Schematic\_2, but as you remember we have renamed C8 and C10 capacitors directly on the board. Of course, we can rename that components manually in the schematic or use the **Back Annotate** feature.

Go to "File \ Back Annotate" from the main menu, and select the PCB file where we saved modified copy of the PCB\_2 board ("PCB\_2\_ver1" in our case), then press **Open**. Now you can see that all designators in the Schematic (in our case C28 and C30) are changed according to the PCB.

*Notice that net names and net classes are also back annotated from the PCB, but this feature has limitation and is not capable of adding new nets or components.*

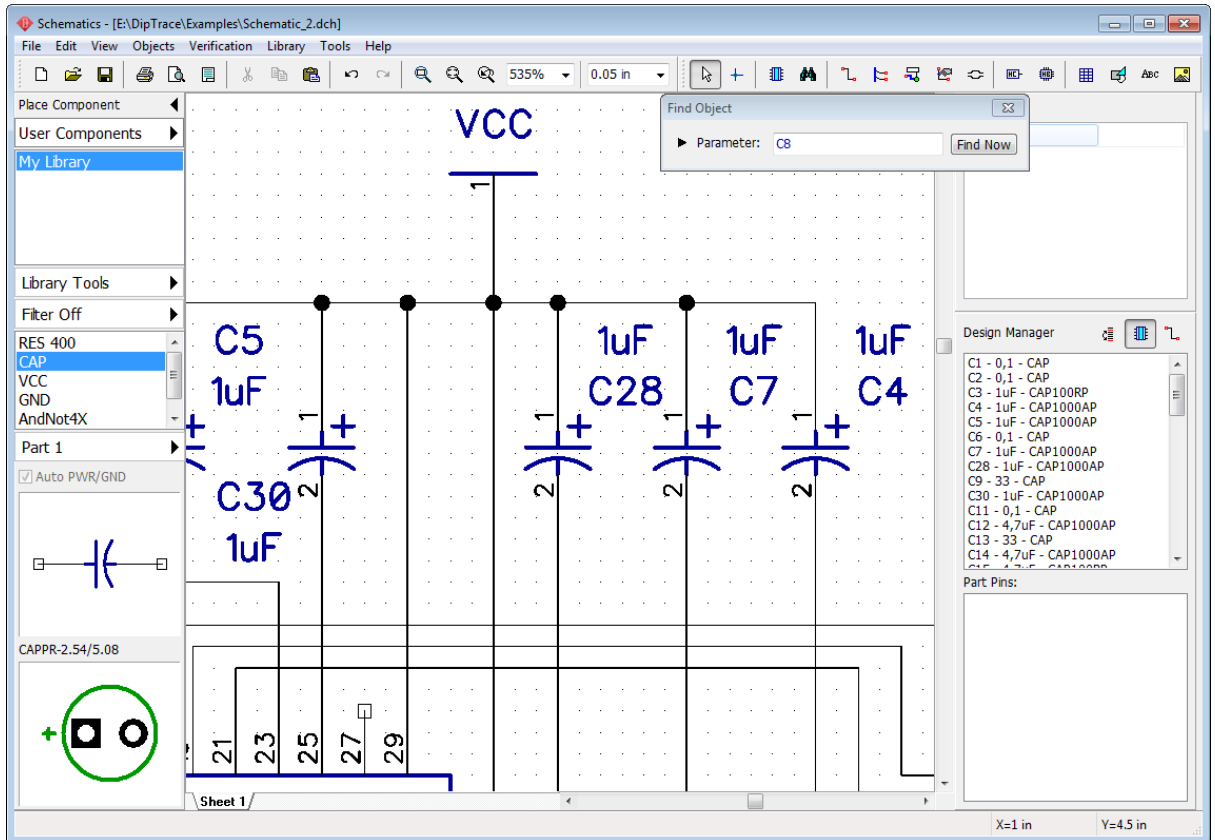

## 5.10 Hierarchical schematic

We will design a very simple two-level hierarchical schematic just to show you how this feature works in Schematic and PCB Layout modules of the DipTrace.

### Hierarchy blocks

Launch DipTrace Schematic. Hierarchy blocks are associated with sheets, so, first of all, we have to add two sheets to the blank schematic, select "Edit \ Add Sheet" from the main menu **twice**. Then specify that additional sheets are hierarchical blocks, not just regular schematic sheets, select the second sheet in the bottom-left corner of the design area, and go to "Edit \ Sheet Type \ Hierarchy Block" from the main menu. Do the same for the third sheet.

Select main (the first) sheet, and place several components there (for example, three UGN3275K components from the Allegro library). This will be the main circuit. It doesn't have any hierarchy blocks yet.

Select the second sheet, then go to "Object \ Hierarchy \ Place Connector" from the main menu or press  button on the Objects toolbar, and place several hierarchy connectors to the second sheet (notice that you can not place hierarchy connectors to non-hierarchical sheets).

*These connectors are the inputs and outputs of the hierarchy block, position and rotation of the connectors is the location of the hierarchy block pins on the main sheet.*

Place eight connectors, four on the left side and four on the right. Add two diodes from the Diodes library, connect them to the connectors, leave some free space for the upcoming

hierarchy block of the second level. Use *R* hotkey to rotate hierarchy connectors.

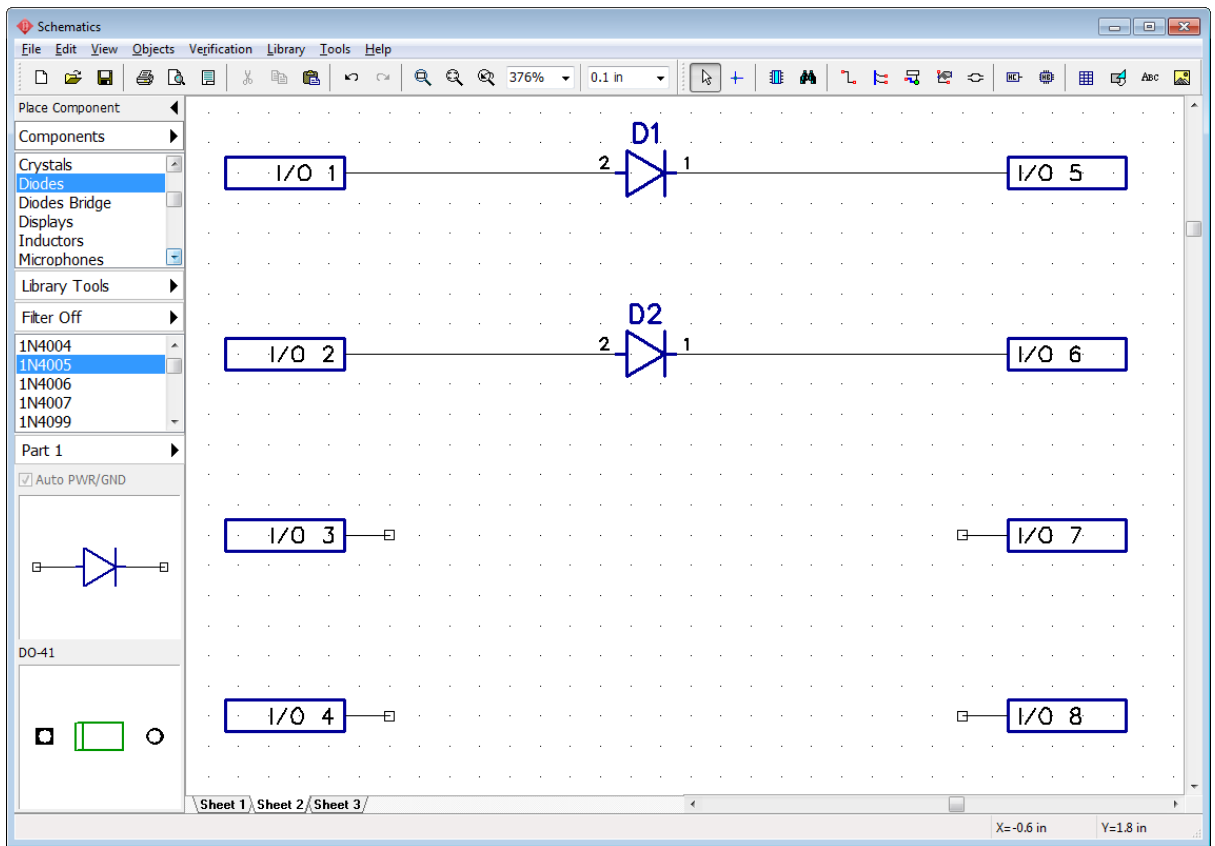

Select Sheet 3, and create the second hierarchy block here. Place several hierarchy connectors (two on the sides and two at the bottom), add couple components (for example, two AD1317KZ components from Analog Devices library), and connect them.

*Notice that you can rename hierarchy connectors in the right-click submenu (select the first item from the drop-down menu). Connector name will be the name of the block's pin on the main circuit.*

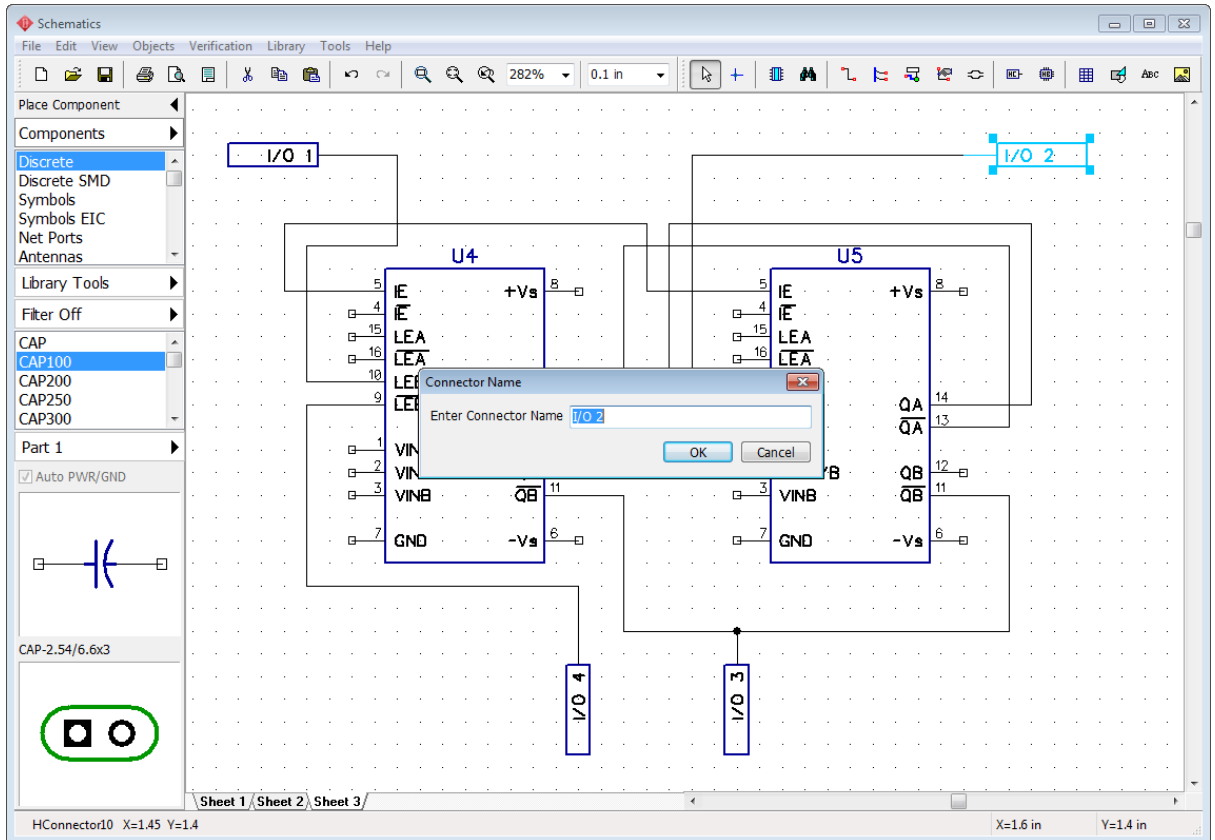

DipTrace supports multi-level hierarchy, i.e. **hierarchy blocks can be inserted into the main circuit and into each other** as many times as needed.

Select Sheet 2, then go to "Objects \ Hierarchy \ Place Block" or press  button on the Objects toolbar. In the pop-up dialog box with the list of available hierarchy blocks, select Sheet 3, and place two blocks (Sheet 3) into the second sheet (Sheet 2). Use *R* to rotate blocks.

Notice that you can place Sheet 2 inside itself or make a closed loop of hierarchy blocks, but it is an error. To avoid this situation, use "Verification \ Check Hierarchy" from the main menu. DipTrace PCB Layout also checks hierarchy for closed loops and displays the warning message when you open schematic with hierarchical errors.

We are not making any closed loops right now, just place two Sheet 3 blocks into the Sheet 2, and connect them to connectors like in the picture below.

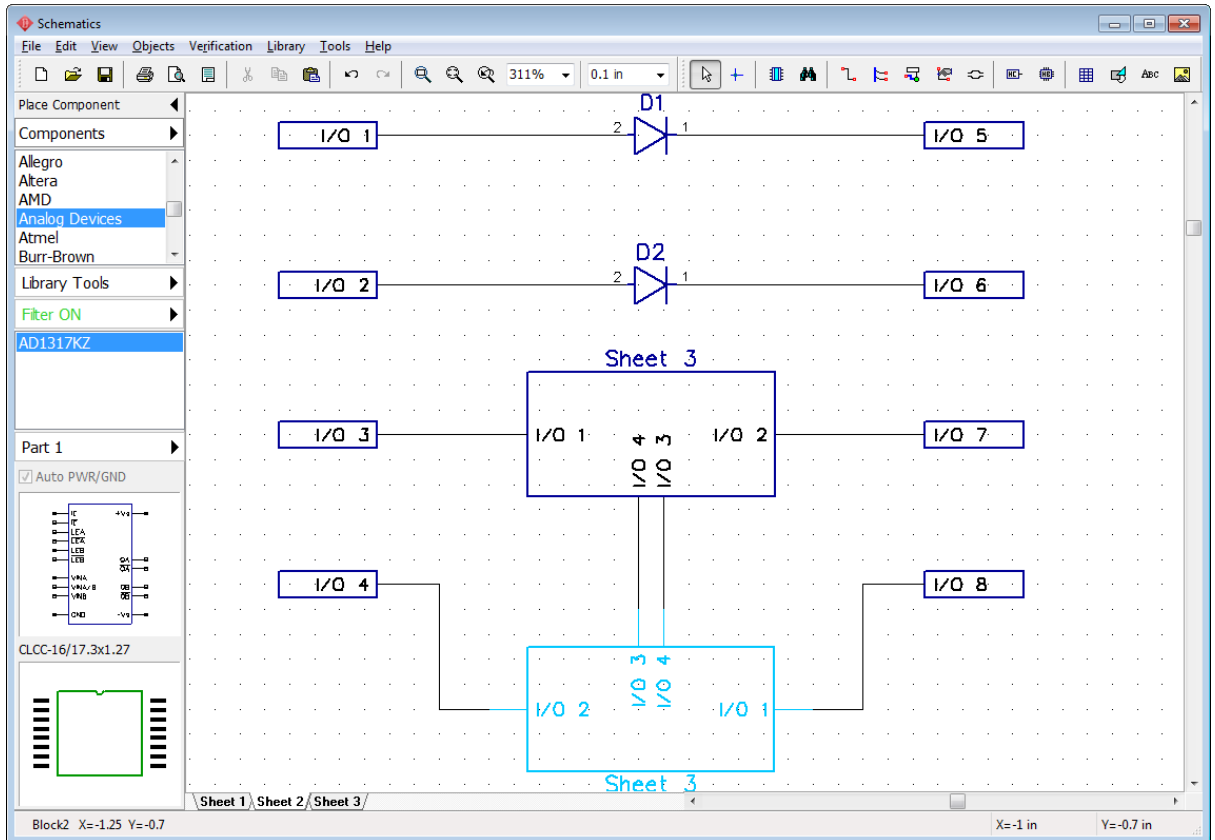

You can rename hierarchy blocks just like regular sheets, right-click on the corresponding sheet tab in the bottom-left of the design area, and select **Rename** from the submenu.

Select the main sheet, and place hierarchy blocks to the main circuit (for example, add two Sheet 2 blocks and one Sheet 3, like in the picture below). Connect hierarchy blocks with other components of a schematic.

*Notice that hierarchy blocks are similar to regular components, they have pins and you can rotate or move them around the design area.*

*This circuit is not a real-life project, it's just a demo example for this tutorial.*

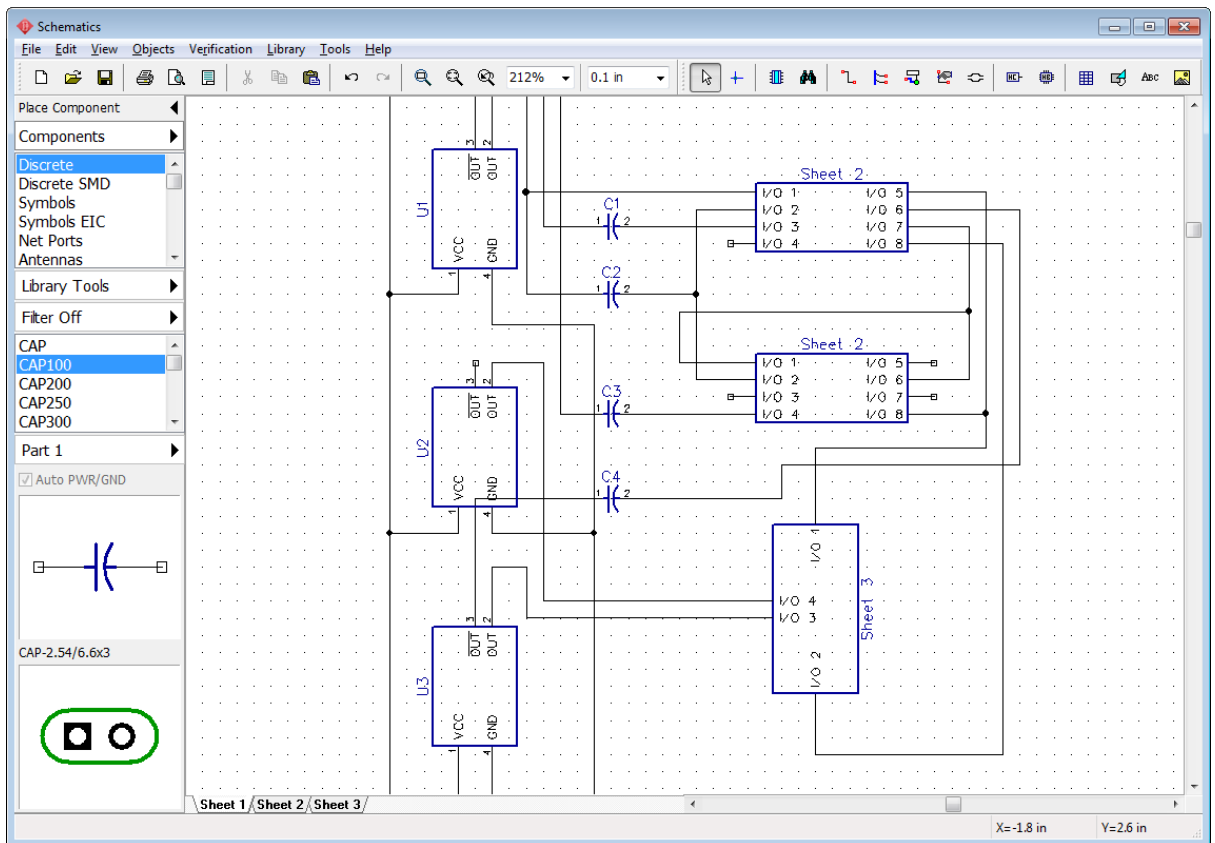

### Global nets

As you already [know](#)<sup>[163]</sup>, pins on different levels of hierarchy **can not** be connected with a single net, unless it is a special-type net called "global". Global nets exist on different levels of hierarchy and **do not** depend on the hierarchical structure of the schematic.

Return to Sheet 3, and place a ground (GND) net port from the Net Ports library, then connect it to GND pins of U4 and U5 components. Notice that the net has automatically become global.

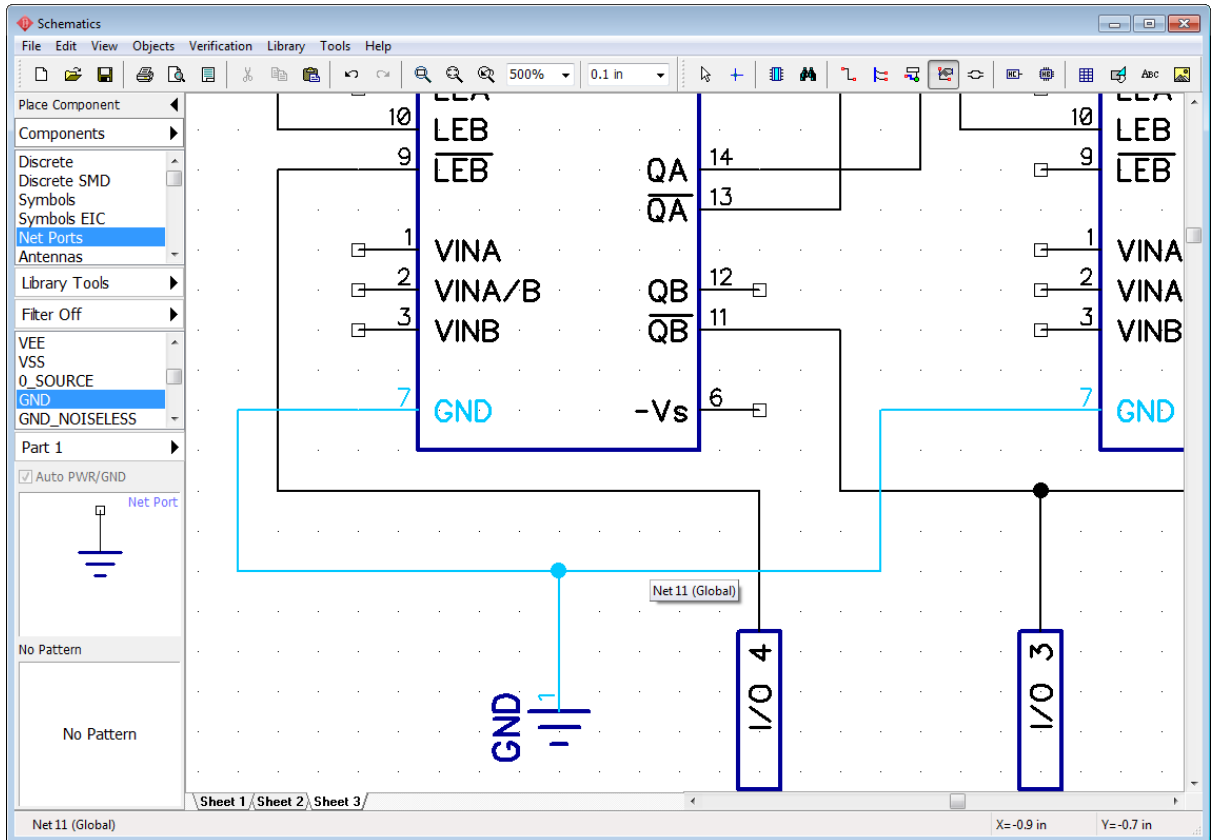

Select Sheet 1 (the main circuit), and place GND net port there, then connect it (create a wire from the net port to some free GND pin). You'll notice that this net now becomes Net 11 (Global). We have a single global net on two hierarchical levels. We can continue this net into Sheet 1 etc. Rename net to "GND".

*Notice that the same net ports anywhere on the circuit are automatically connected to a single net (Global – if in the hierarchy).*

You already know how to [connect nets by name](#)<sup>163</sup>, creating global nets does not differ a lot. Right-click on a random net, and select **Properties** from the submenu. In the pop-up dialog box check **Global Net for Hierarchy**, and **Connect Nets by Name** checkboxes. Type in the name of the global net that already exists, and press **OK**.

### Hierarchy in the PCB Layout

Convert this hierarchical schematic to the PCB. Press *Ctrl+B*, and select **Use Schematic Rules**. In the PCB Layout module components that were in the hierarchy blocks are

superimposing each other, [arrange](#)<sup>173</sup> them with  button on the Placement toolbar).

*Notice that all components have the same reference designators as in the Schematic + the hierarchical block index.*

Use "View \ Component Markings \ Main \ RefDes" to display the reference designators if they are hidden.

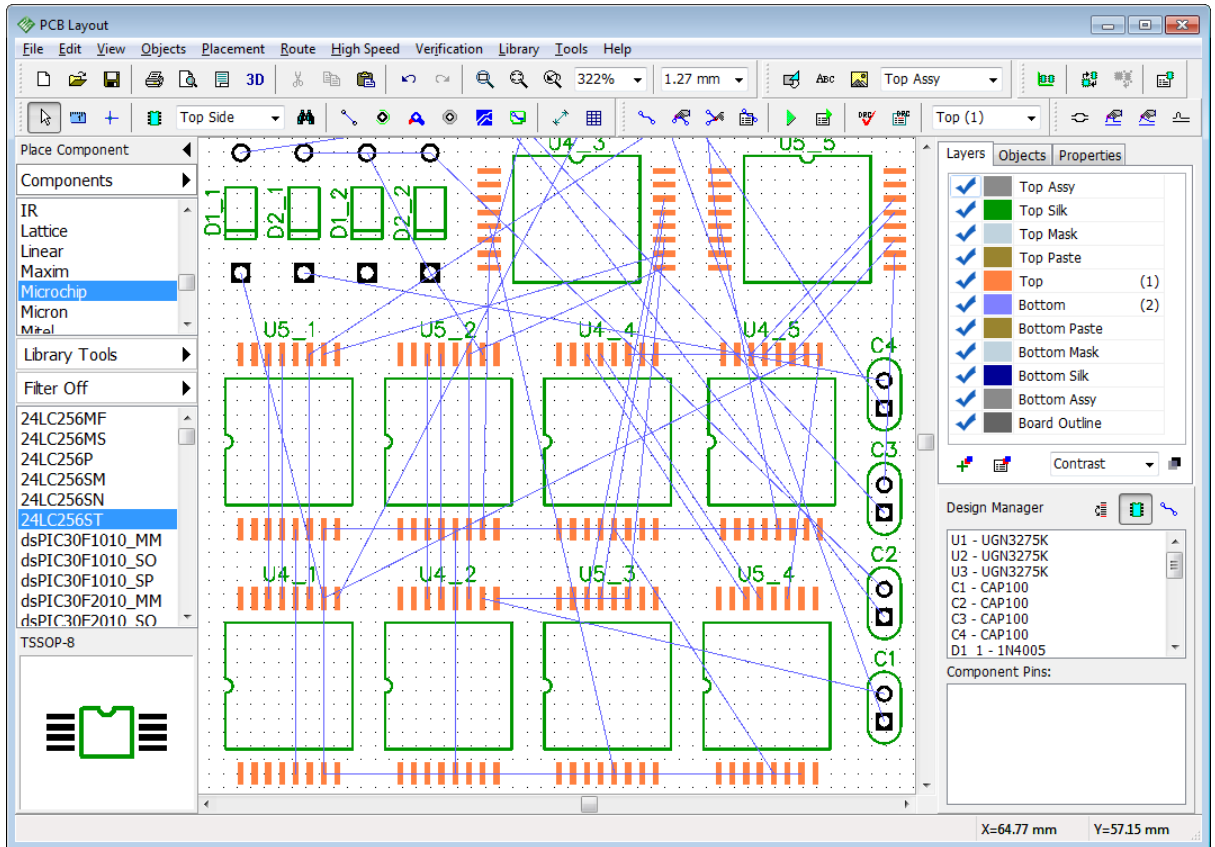

Right-click on one of the components that were in a hierarchy block, and select **Properties** from the submenu. Notice that component involved in the hierarchy has an additional field with each hierarchy block RefDes and component RefDes (path). This additional field is used while updating the PCB by RefDes ("File \ Renew Design from Schematic" from the main menu).

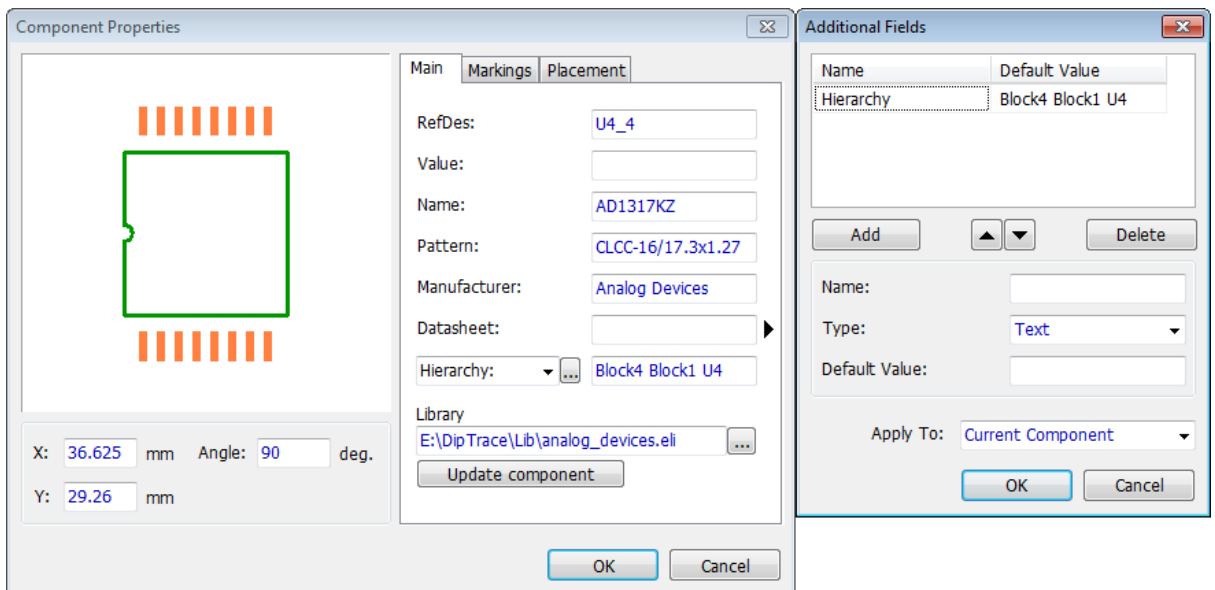

DipTrace works with hierarchy circuits in the PCB Layout module. You can automatically **arrange components by hierarchy blocks and apply routing and component placement from one block to another similar block**. On the printed circuit board all components, regardless of their hierarchy level, are on the same layer.



Select "Route \ Hierarchy" from the main menu. There are two hierarchical sheets available (the same as in the Schematic). Select Sheet 2, and you will see two actual hierarchy blocks (because Sheet 2 was inserted two times into the main circuit in the Schematic). Select Sheet 3 and you will see five blocks inside it (because Sheet 3 was inserted two times into each Sheet 2 hierarchy block, and inserted once directly into the main circuit in the Schematic). Notice that the name of the block of higher hierarchical level is listed in the brackets. When you select a hierarchical block from the list, you can see components and nets that belong to this block on the right in the **Block Content** field.

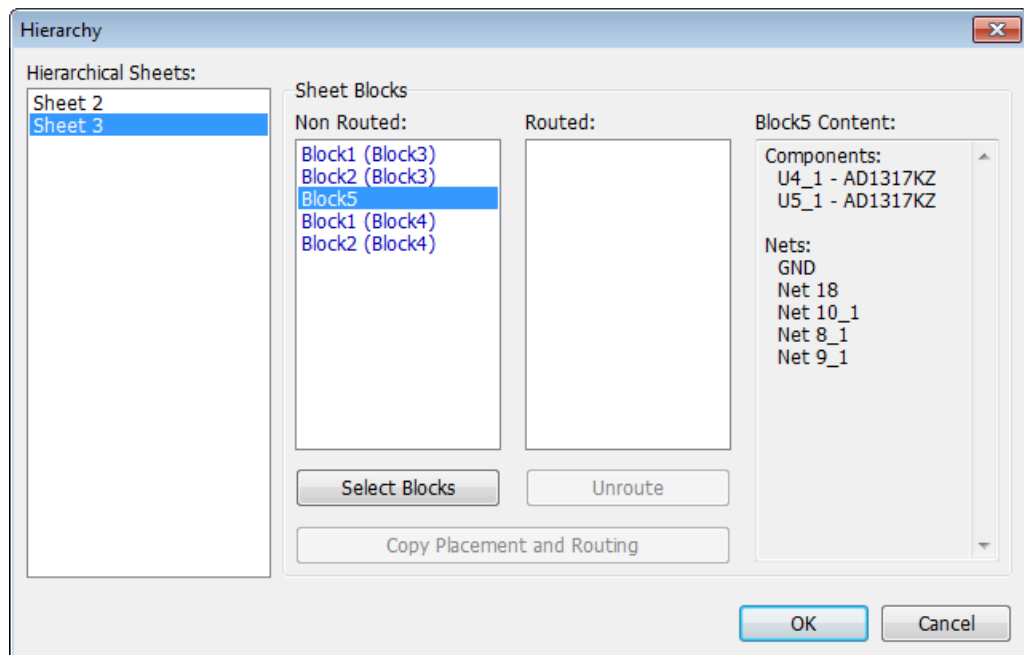

None of the blocks is routed at the time.

First of all, we need to arrange components by blocks on the circuit board, select hierarchy block in the list and DipTrace highlights its components on the design area. Press **Select Block** button to arrange components by selected hierarchy blocks.

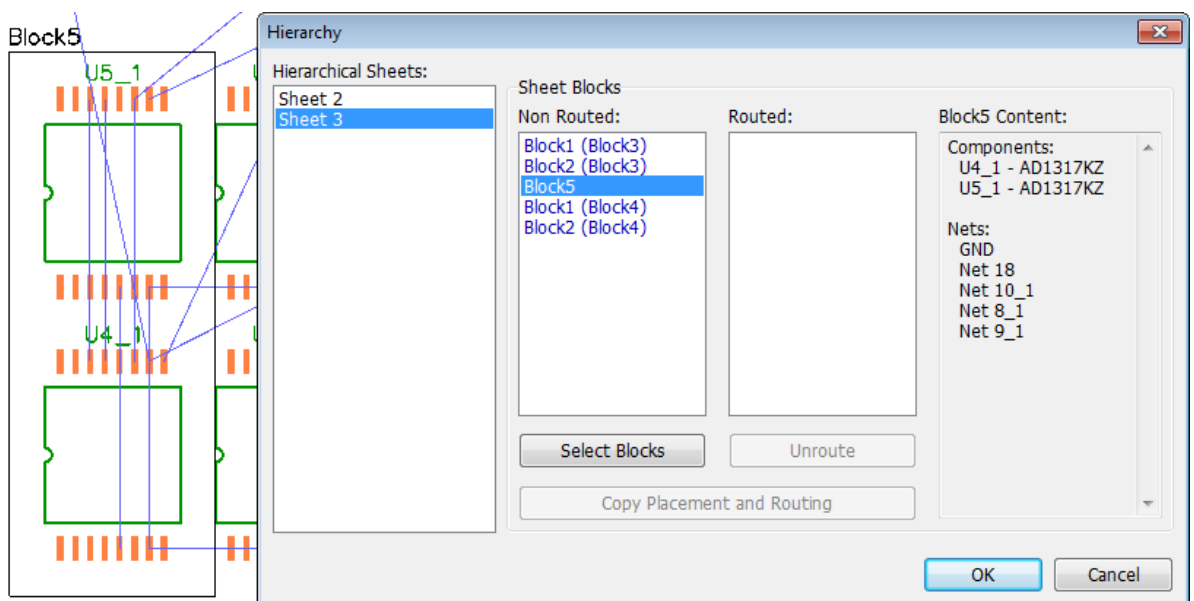

We will arrange components of the two hierarchy blocks on the board, select Block3 and

**Block4** from the **Sheet 2** (use *Ctrl* to select two blocks at a time), press **Select Blocks** button, and then press **OK** to close the dialog box and apply arrangement. Now two blocks of components are clearly visible on the design area. We will work with Block 3, which is right below the Block 4.

Change the layout of components in the Block 3 and route traces automatically, do not route global nets. Since GND is a global net, we need to **exclude the GND net from the autorouting**. Right-click on any pad that belongs to the GND net, select **Net Properties** from the submenu, and in the pop-up dialog box specify **Auto-route Mode: Don't Route**. Press **OK** to apply.

*Notice that global nets should be routed only after finishing routing and arranging components in the hierarchy blocks.*

Now let's route the traces, right-click on component pad, and select **Route Net** from the submenu or right-click on the component, and select **Route Traces** to route all nets of this component. Autorouter automatically creates a rectangular board outline. Edit traces manually if you need.

Notice that we didn't autoroute the entire board: only the traces inside the Block 3, some connections to Block 4, traces to components from the main schematic sheet.

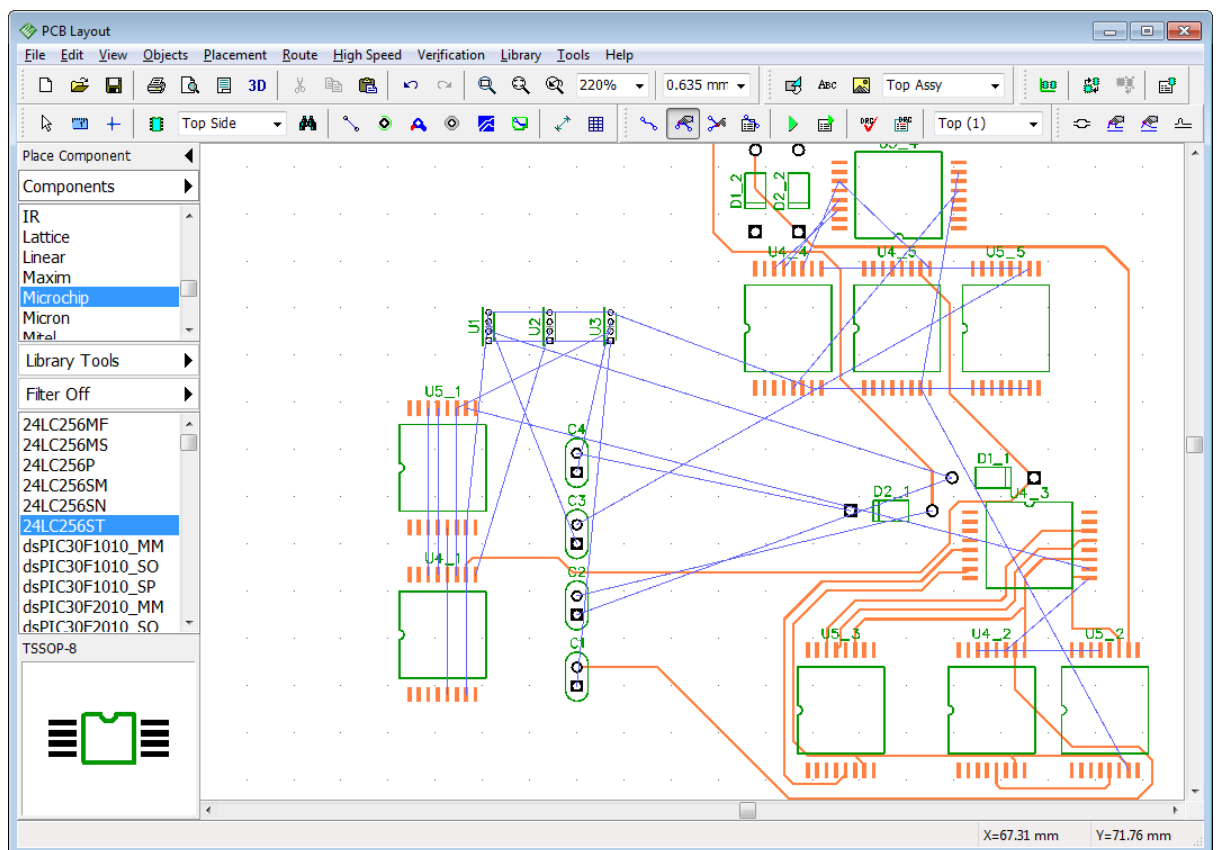

### Copy placement and routing between hierarchical blocks

Go to "Route \ Hierarchy" from the main menu, select **Sheet 2** again. This time Block 3 is routed. Select Block 3 from the **Routed** list, and Block 4 from the **Non Routed** list, then press **Copy Placement and Routing** button to apply Block 3 placement and routing to the Block 4.

If you have routed many traces from Block 3 to Block 4, the Block 4 can appear in the **Routed** list in the hierarchy dialog box. Just select it, and press **Unroute**, then apply routing and placement.

Let's also apply placement and routing to Block 5 without closing the **Hierarchy** dialog box. Select Block 5 on the Sheet 3, and then select one of the routed blocks, then press **Copy Placement and Routing** button again. Now press **OK** to apply routing.

Routed blocks are next to the board outline, use box selection to move them on the design area.

*Notice that DipTrace didn't copy traces heading outside selected hierarchical block.*

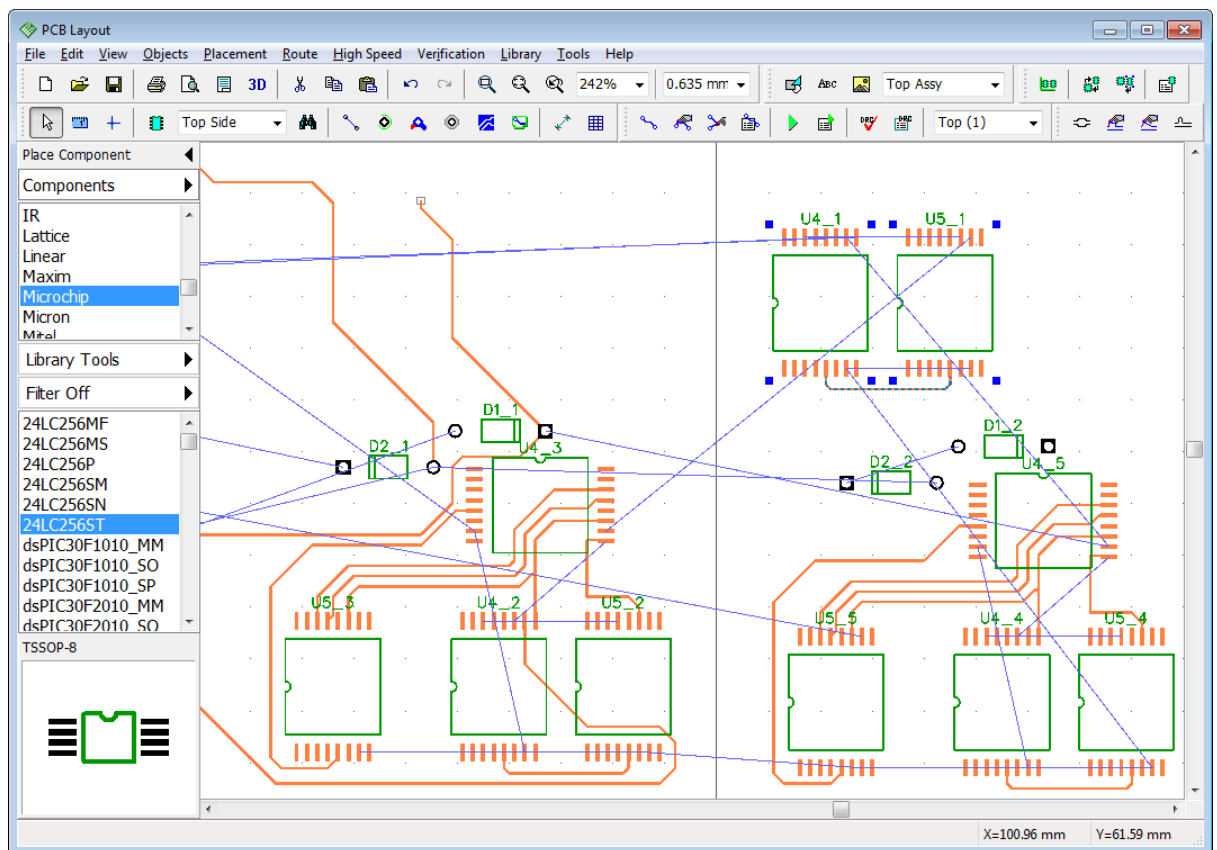

## 5.11 SPICE simulation

DipTrace does not have a built-in simulator, but the program allows the user to define SPICE settings and export SPICE netlist to any third-party simulation software. We will try to simulate astable flip-flop schematic<sup>8</sup> using LT Spice simulation software, which is free and of a good quality. However, if you have another program that you use for simulation, you're good to go.

### Edit SPICE settings

Launch DipTrace Schematic, and open "C:\Users\Spice Settings from the submenu. Spice settings for capacitors are pretty simple: select **Model Type: Capacitor**, enter values into the parameters table (in our

case "22 $\mu$ F"), and specify positive and negative pins (enter values into the pin-to-signal table on the left side of the dialog box, the list of available signals is right below). Notice that you can enter parameters directly into the table cells.

The **Template** field shows how this component is represented in the SPICE netlist. You can scroll that field to the right if it is long. Make sure that settings are like in the picture below.

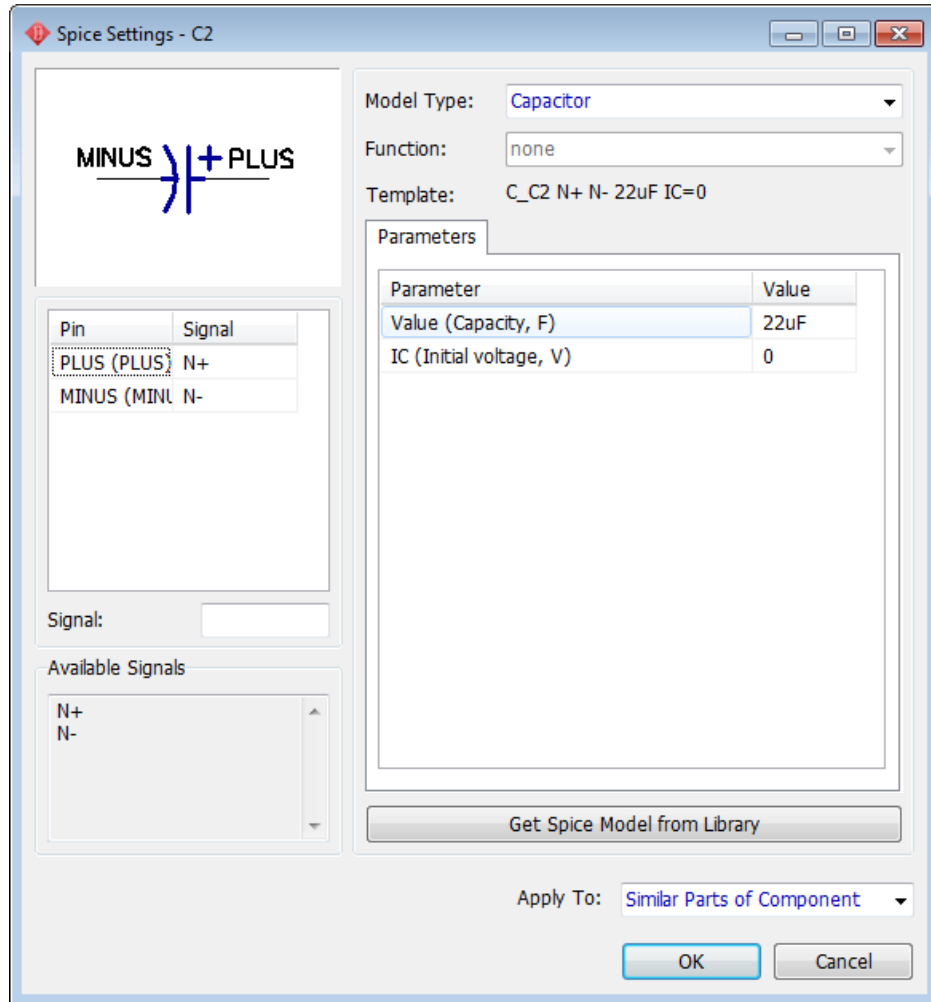

Select another model type, for example, a Current Source. The user can specify a function for this model type. Use the **Function** drop-down list and select **PWL()**. In the pop-up dialog box enter the number of points for PWL function, and click **OK**. Now you can enter the values for each point in the **Parameters** table. Different functions require different parameters (amplitude, phase, etc.). See detailed description in the SPICE language documentation.

Now return to the **Capacitor** model type, and **discard any changes**, or simply close the dialog box.

### SPICE model

Capacitors do not require additional model description, but transistors do. Right-click on the Q1 transistor, and select **Spice settings** from the submenu. In the pop-up dialog box, you can see that there is the **Model** tab near the **Parameters** tab, select it. Now you can enter the model text or load the SPICE model from an external file (**Load** and **Save** buttons). Some component manufacturers publish SPICE models for their components on the web.

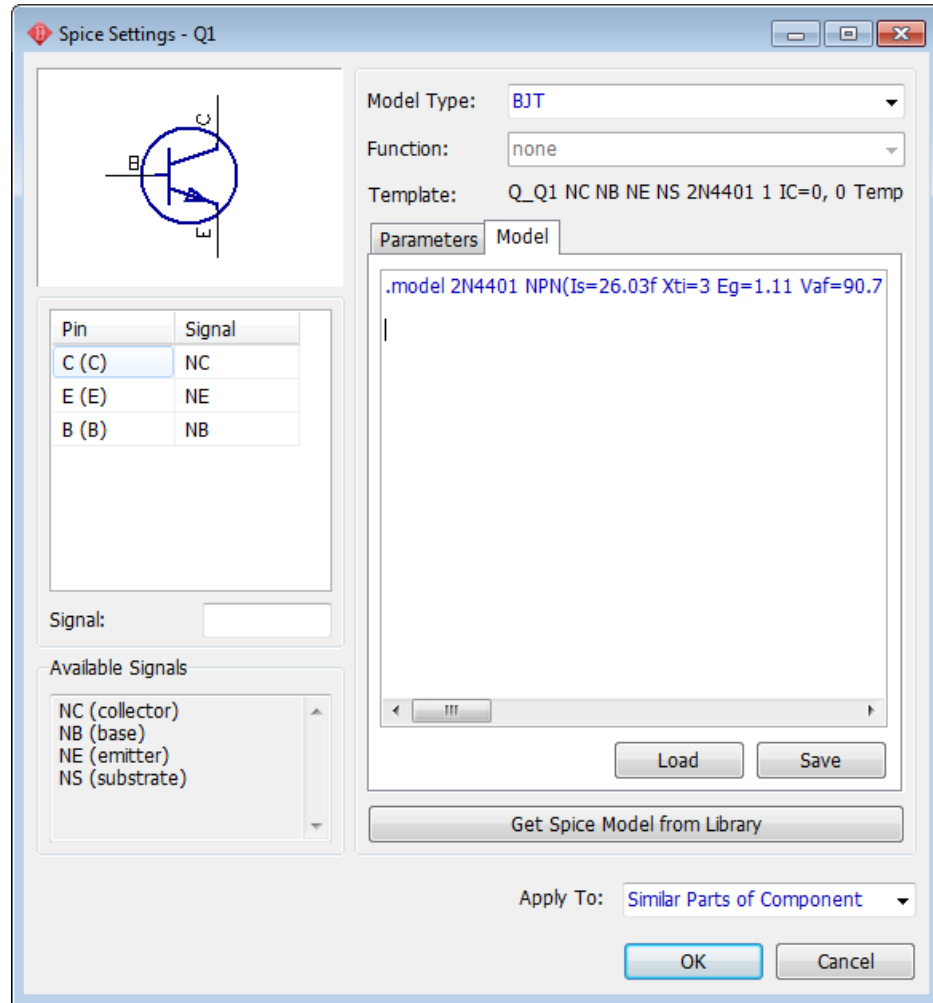

Notice that you can get all SPICE settings from another DipTrace library (use **Get Spice Model from Library** button). Click **OK** or **Cancel** to close this dialog box (discard any changes).

There is no valid SPICE model for the power source (battery) in the `Astable_Flip_Flop_Spice.dch` file, we should define it. Right-click on the B1 component, and select **Spice Settings** from the submenu. You can see that component has the `Voltage Source` model type, but no valid function. Set **Function: PULSE()**, then specify the following parameters in the table below: **Pulse V2=5, Pulse PW=20s, Pulse PER=30s**. Keep other parameters, and press **OK**. Now we have the voltage source that produces 5V during the first 20 seconds, then there is a 10-second interval. Now everything is ready for simulation.

### Export SPICE netlist

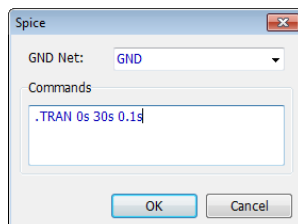

Select "File \ Export \ Spice Netlist" from the main menu. In the small pop-up dialog box select **GND** from the **GND Net** drop-down list. Specify **Commands: .TRAN 0s 30s 0.1s** to simulate the circuit from 0s to 30s with 0.1s step. Notice that you can define/change commands directly in the simulation software. Click **OK** and save the \*.cir netlist file. Launch the SPICE simulator that you have. We will use LT Spice as an example (download it at [Linear Technologies](http://www.linear.com) website).

Select "File \ Open" and open the \*.cir netlist that you just saved (notice that you should select correct **Files of Type**). Now you can see the netlist in the text format. Select "Simulate \ Run" from the LT Spice main menu, and close the error-log dialog. Select "Plot Settings \ Visible Traces", and choose I(D\_led1) to see electrical current on LED1. This component works during the first 20 seconds, then has 10 sec interval. Select other signals to see how they work.

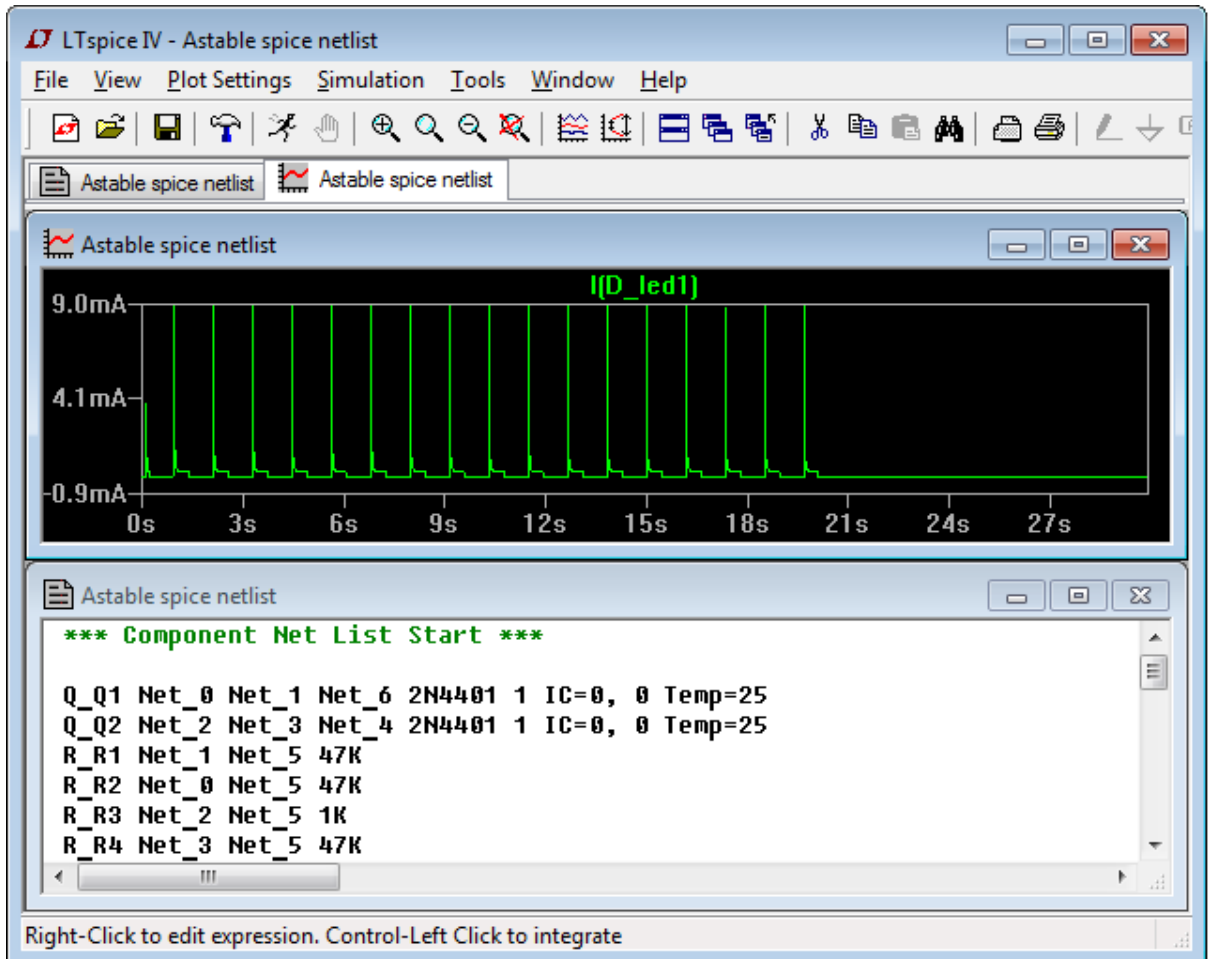

## 5.12 Saving/loading design rules

In the [Converting to PCB](#)<sup>[29]</sup> topic of this tutorial, we mentioned that you could use Schematic rules or load rules from any PCB layout project while converting schematic to the PCB. No need to specify all layers, net classes, via styles, and design constraints again. Let's see how it works.

Create a new layout, select "File \ New" from the main menu or press *Ctrl+N* hotkeys. In the pop-up dialog box, you can choose to create an empty layout or use settings from the previous project.

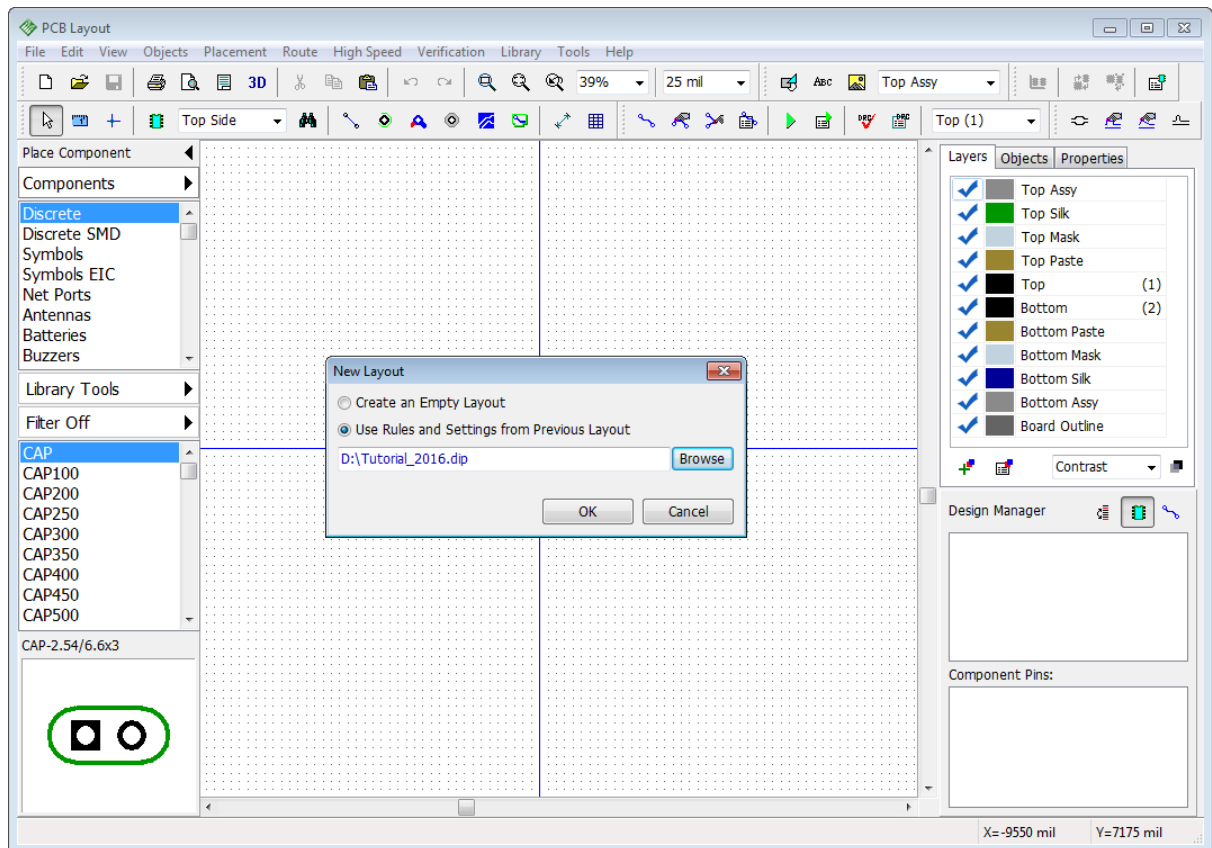

Check **Use Rules and Settings from Previous Layout**, press **Browse**, and select the \*.**dip** file of the circuit board that contributes its settings for a new layout. Press **OK**. In our case, we have selected the \*.dip file of the project that we have created in the first paragraph of this tutorial. Layer colors and some DRC settings were changed.

In the DipTrace PCB Layout, you can save settings in the special file, separately from the layout itself. Just go to "Route \ Save Rules" from the main menu, enter the file name, and press **Save**. Now you can use rules and settings from this file while creating new projects. Go to "Route \ Load Rules" and choose the \*.dip or \*.rul file.

Please add some via styles, a new net class with random parameters, GND and PWR inner layers and save this as a \*.rul file. We will use it later in the [Fanout](#)<sup>[208]</sup> topic.

## 5.13 Electrical Rule Check

Electrical Rule Check (ERC) feature is one of the main verification features in DipTrace. ERC checks the circuit for pin type conflicts, unconnected and superimposing pins as well as one-pin nets and short circuits.

Launch DipTrace Schematic and open Schematic\_2.dch from the "Documents/DipTrace/Examples" folder. Define electrical rules, select "Verification \ Electrical Rule Setup" from the main menu. In the pop-up dialog box specify incompatible pin-to-pin connections and the program's reaction to them (error, no error or warning, depending on the color) by **clicking in the grid cells** with green, yellow and red squares.

**Pin Type** checkbox in the **Rules to Check** section means checking pin-to-pin connections defined in the grid;

**Not Connected Pins** – the program searches for unconnected pins;

**Pin Superimposing** – the program searches for pins overlaying each other;

**Only One Pin in Net** – the program reports nets with only one pin, i.e. net that makes no sense. It can be a potential error in the net structure;

**Short Circuit** – the program reports any connections between Power and GND nets. Let the software know which net is POWER and which one is GROUND in the **Power Pins for SC** section below.

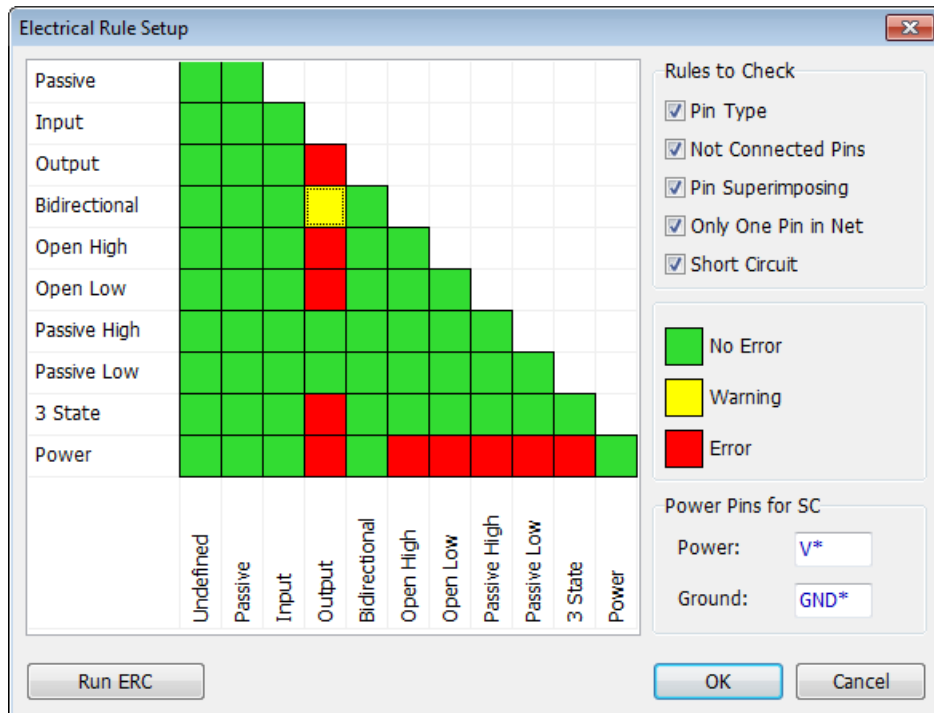

Press **OK** to close the dialog box.

Now select "Verification \ Electrical Rule Check (ERC)" from the main menu. If you verify "Schematic\_2.dch" file, according to the rules from the picture above, you should get many error reports in the list: one warning for Bidirectional to Output connection and a lot of Not Connected pin errors. To localize error on the schematic design area, double-click it in the list (or press **Localize**). You can fix errors without closing the ERC report dialog box. Press **Run ERC** button to start verification again.



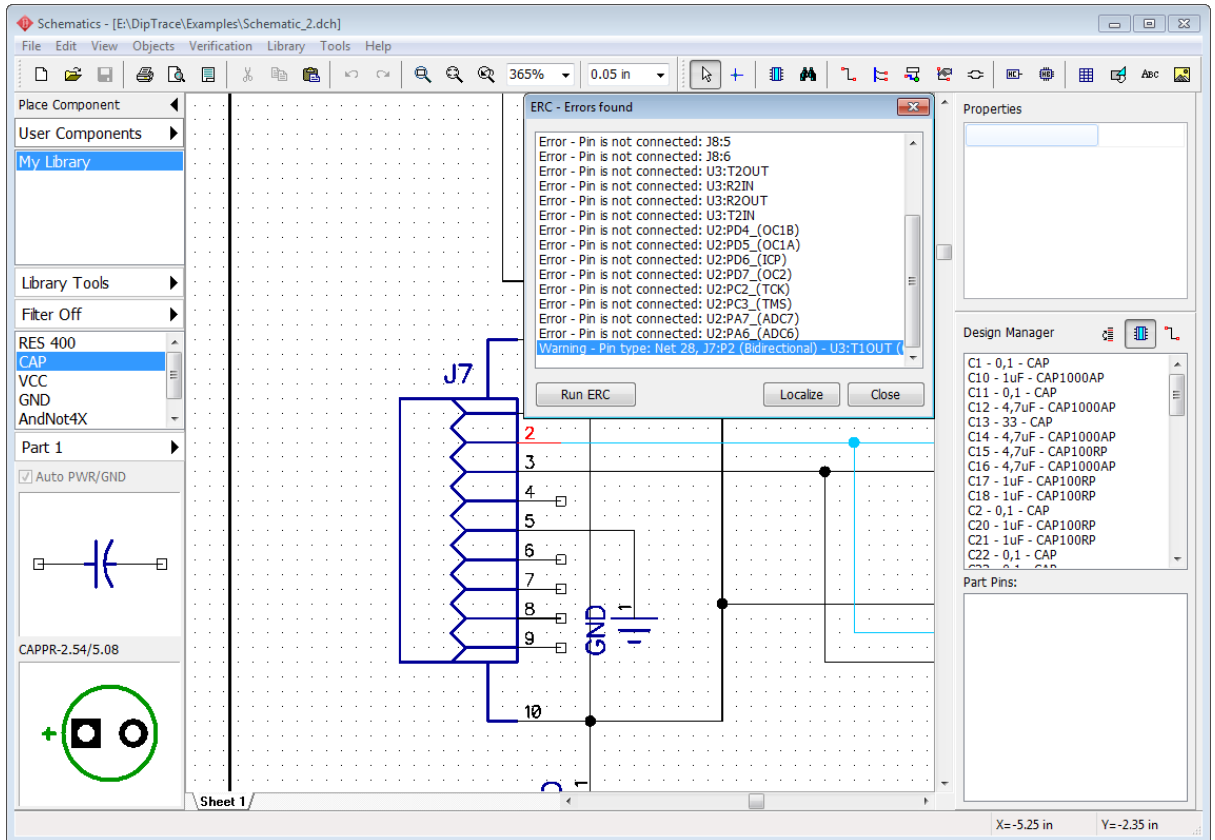

ERC does not report errors for pins, which are intentionally unconnected. Right-click on one of these pins, and select **Not Connected** from the submenu. Alternatively, you can uncheck the corresponding item in the ERC settings dialog box, but then the possibility of an error increases, because all unconnected pins are now OK, even if it is not supposed to be that way.

## 5.14 Checking net connectivity

This type of verification allows the user to check if all nets on the circuit board are connected. Net connectivity check reports broken connections and isolated copper areas (not depending on the connection type: traces, thermals, shapes, or copper pours).

Launch the PCB Layout module, and open "PCB\_2.dip" file from the "C:\Users\OK to launch verification.

The circuit board does not have any unconnected nets. Therefore, we will make two errors intentionally.

Close the error-log dialog box, press  button on the Route toolbar, then move the mouse to the trace that connects C16:2 to the via and GND copper pour in the Bottom layer, right-click on this small trace segment, and select **Unroute Trace** from the submenu. This is going to be our first error.

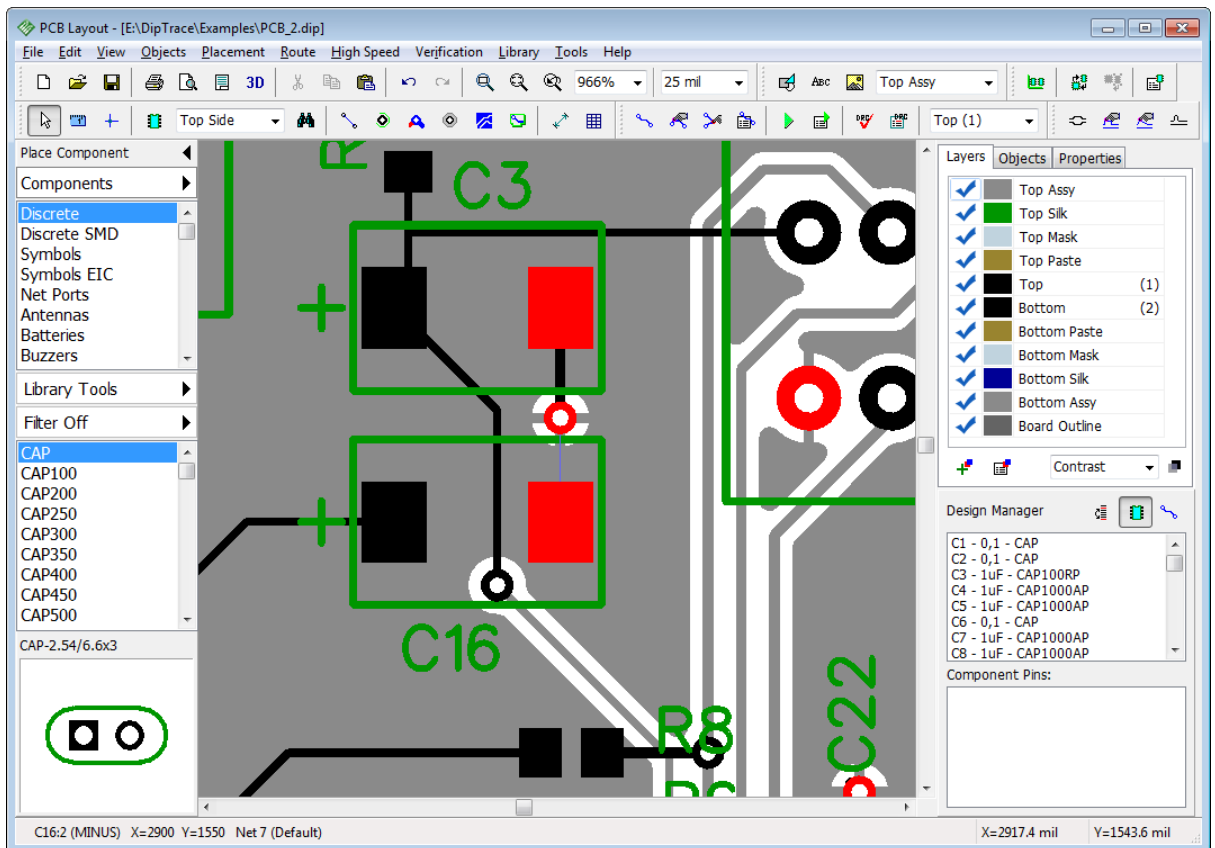

Isolated copper pour area is the second error that we are about to commit. Double click on the Bottom layer, then pan to the bottom-right corner of the circuit board, and draw a couple of shapes (arcs or lines) to isolate one of the vias, and don't forget to update the copper pour (right-click on the copper pour's outline, and select **Update** from the submenu).

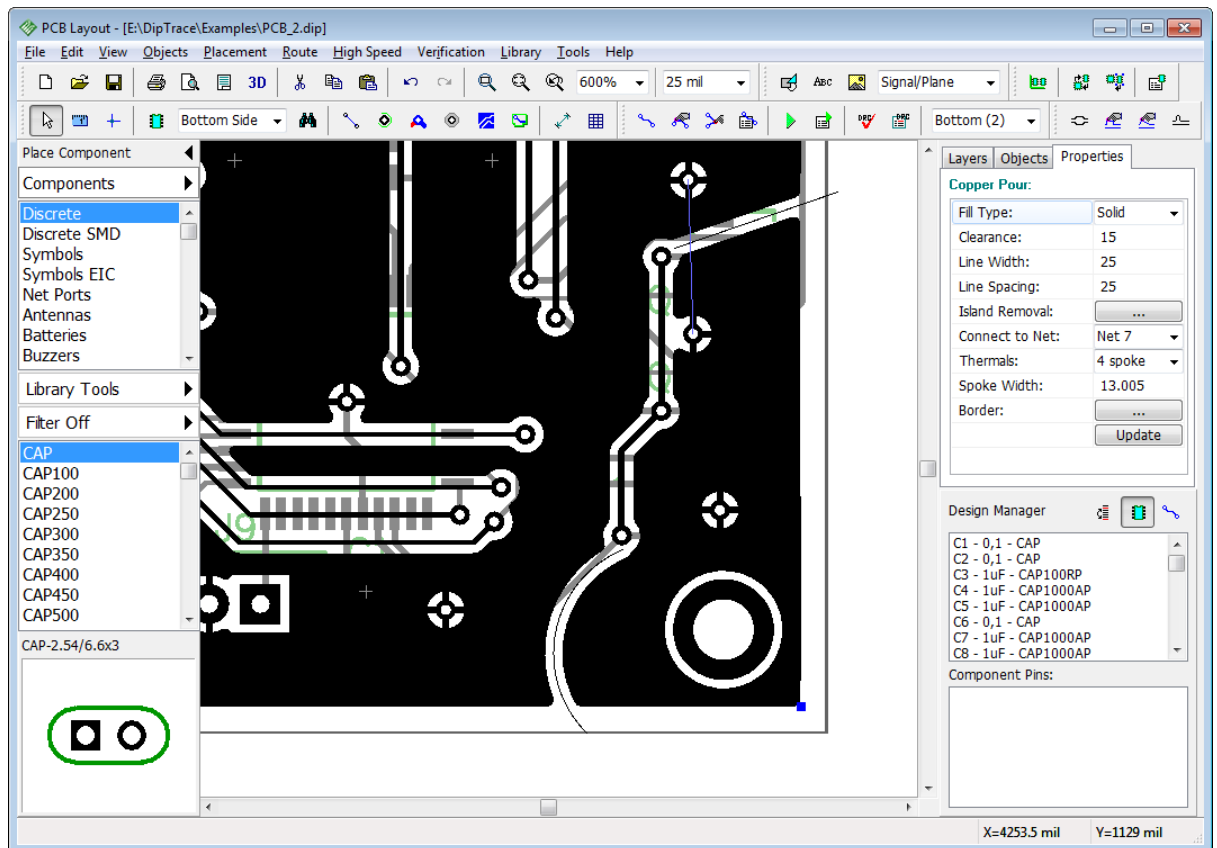

The picture shows a simple situation when it's very easy to find the mistake, but most errors of this type (isolated copper pour areas and non-connected pins) usually go unnoticed on complex circuit boards.

Go to "Verification \ Check Net Connectivity" from the main menu, and click **OK** in the pop-up dialog box. The verification reports a broken-net error. Click on the error in the list, and check error **Details**. We have Net 7 broken to 4 unconnected areas, scroll down the **Details** section of the **Connectivity Check Results** dialog box to see all unconnected areas of the net and component pads sorted by areas. Area 1 is the biggest, it is the main part of the copper pour, the second area is that C16 capacitor's pad which trace we unrouted at the beginning of this topic, the Area 3 and Area 4 appeared as the result of isolating the part of the copper pour at the bottom-right of the circuit board.

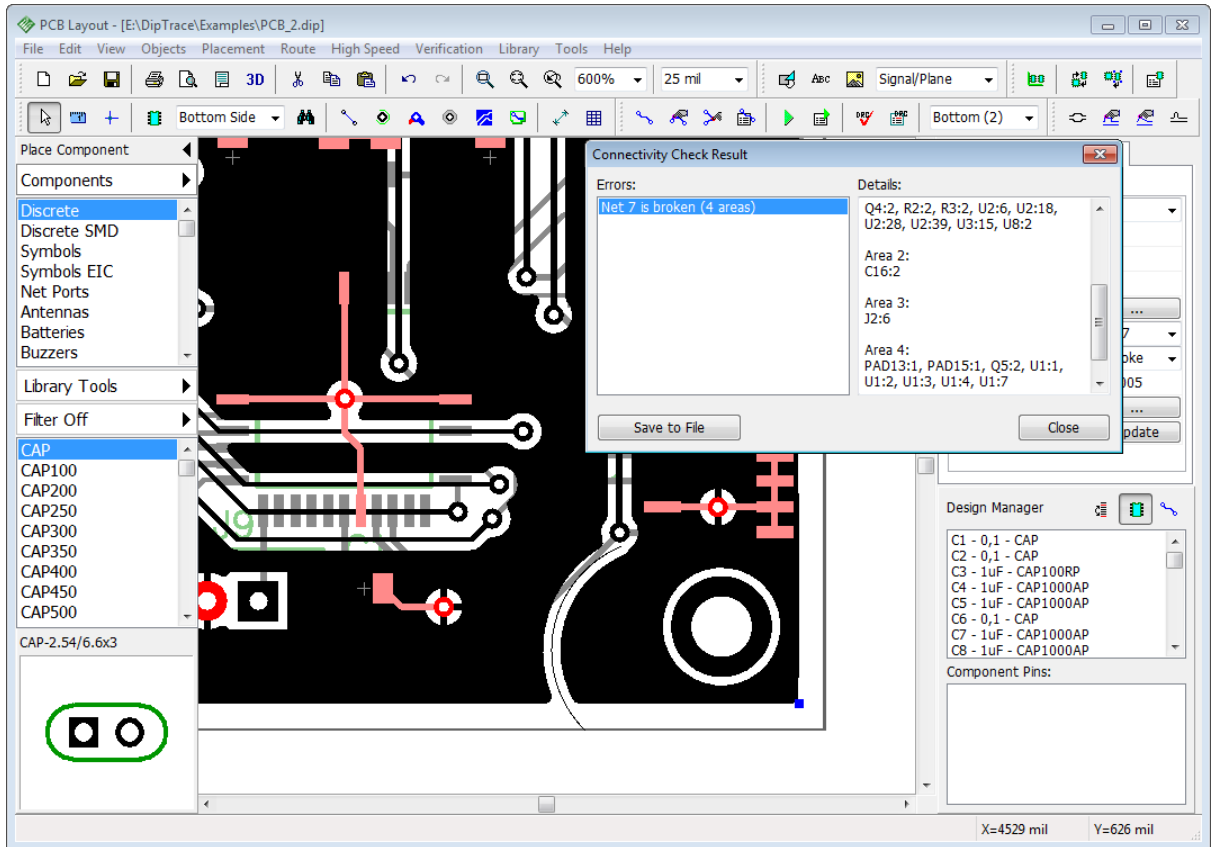

You don't have to close the **Connectivity Check Results** dialog box to fix errors, just move it a bit.

Sometimes it's hard to understand how to find and fix errors on the design area. We recommend using the [Design Manager](#)<sup>30</sup> for easy navigation. Just scroll down the list of components and double click on the component in the list to highlight it on the design area.

You can also save the net connectivity error report into the text file.

## 5.15 Bill of Materials (BOM)

DipTrace Schematic module has the BOM feature that allows the user to customize columns and rows, add tables or pages to the existing project, export files to Excel CSV format or save the Bill of Materials as a text file with appropriate table formatting.

Select "Objects \ Bill of Materials" from the main menu. There are two main sections in the pop-up dialog box: Table Rows and Columns. Specify **Group Rows by: Components** and adjust **Row Height** if you need.

Include Power/GND parts checkbox allows the user to include the corresponding parts to the BOM file.

Include Net Ports checkbox allows for net ports in the BOM table.

RefDes by Open Hierarchy allows the user to show RefDes with hierarchy block prefixes.

The other checkboxes help to add a header, row number, and total quantity.

Now add columns to the BOM file with the settings like in the picture below. Select the corresponding item (**Quantity**) from the **Show:** drop-down list, and press **Add** button. You

can add or delete rows from the table. Press **Set Font** button in order to customize the font settings. Use only TrueType fonts for Unicode characters.

Set **Create On: New Sheet(s)** and **Sheet Templates: A4 Blank**. Check **Adjust by Width** to stretch table according to the page width.

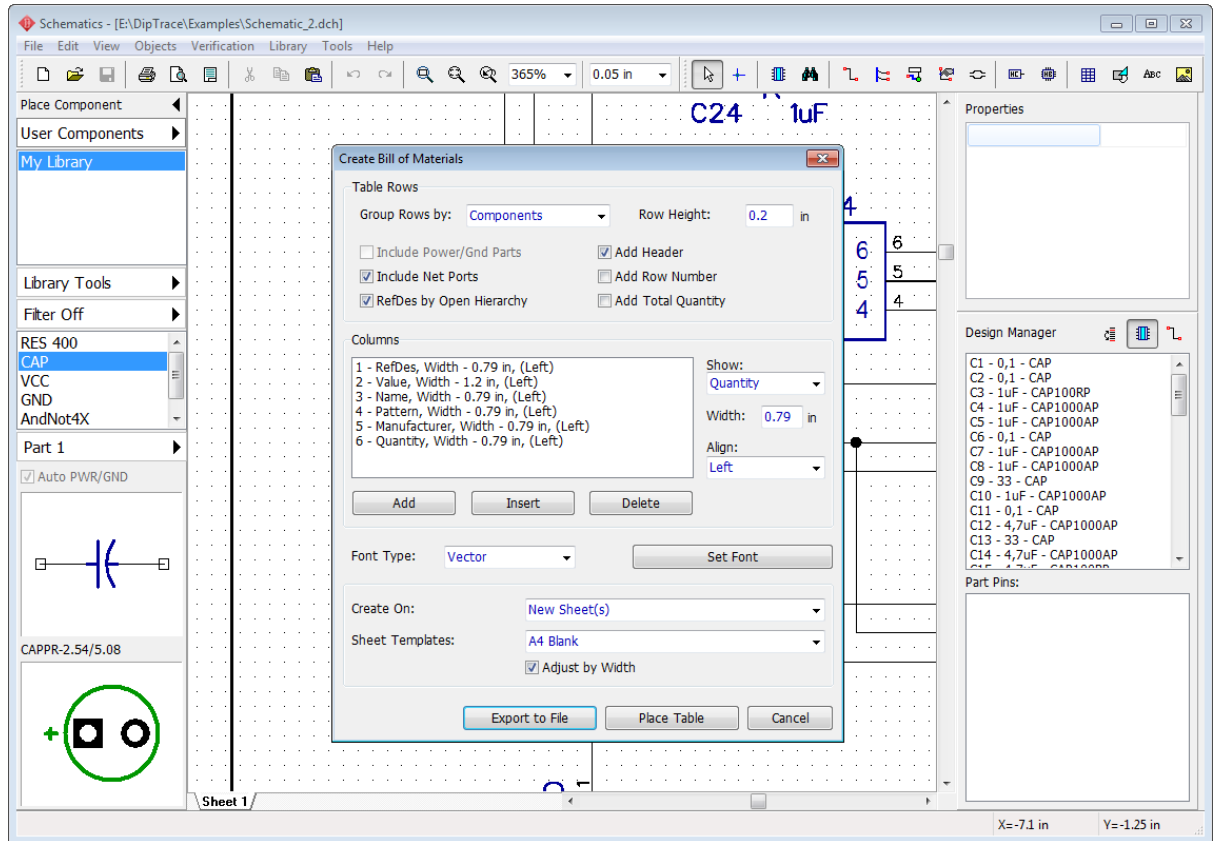

Press **Place Table** button to add new A4 sheet(s) with ISO title and BOM table to the current project (several sheets for big projects or detailed BOM). Do not forget to check **Display Titles** and **Display Sheet** in the **View** main menu item if you need.

Select Sheet 2 or Sheet 3. Notice that you can edit the row height, the number of lines for cells, alignment, font, etc., just left-click the cell, and make necessary customizations in the pop-up dialog box.

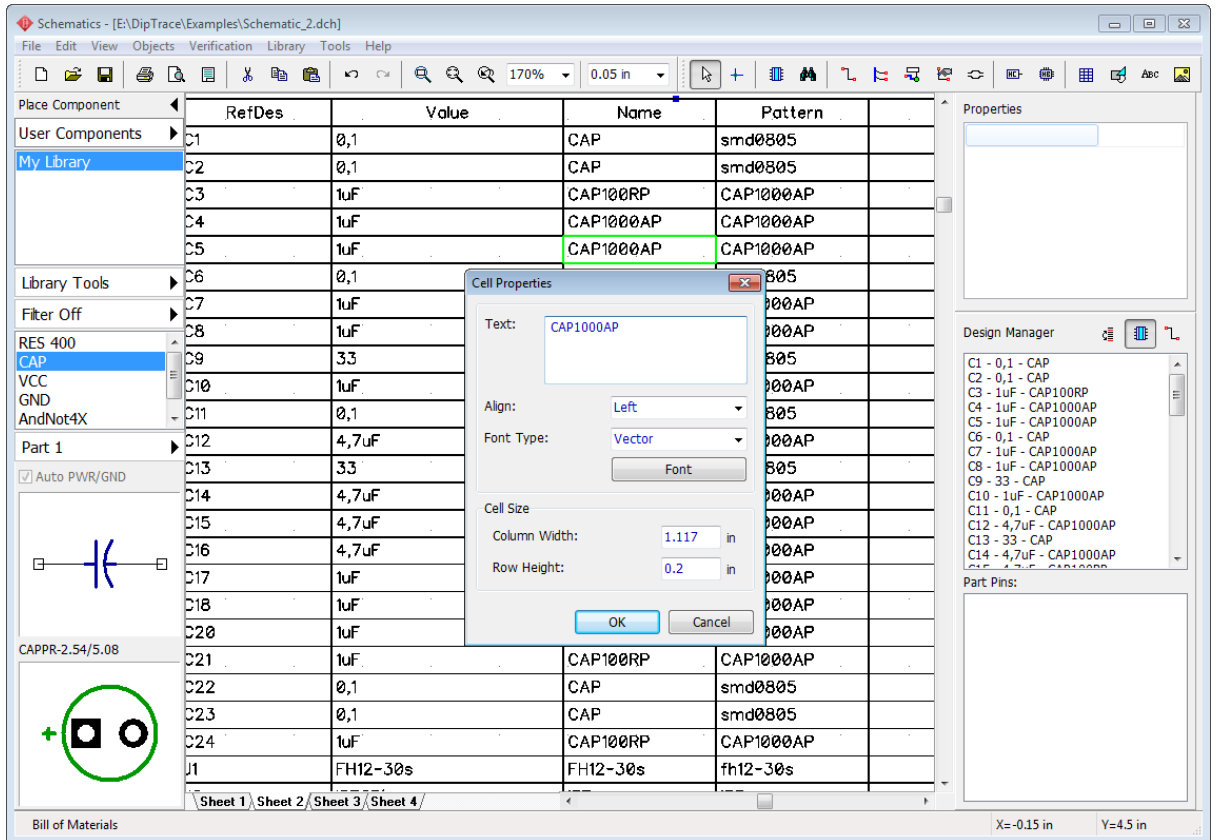

Notice that you can place the BOM table to the same sheet as the circuit: set **Create On: Current Sheet**, press **Place Table** and left-click on the design area. If you have a multi-sheet schematic with many components, a separate BOM is possible.

If you need some columns that can not be inserted directly in the DipTrace BOM dialog box, you can left-click on the table on the design area and select **Insert Column** or **Insert Row** from the submenu.

You can save the Bill of Materials into CSV-file or text-formatted table, just right-click on the existing table, and select **Save to File** from the submenu. Then you can open this CSV file in any spreadsheets editor.

## 5.16 Importing/exporting netlists

DipTrace allows the user to import and export netlist files of various formats (Accel, Allegro, Mentor, OrCAD, PADS, P-CAD, Protel, Tango). Netlist export can be used to review schematic net structure or board design in other software.

### Export netlist

To export netlist from the DipTrace Schematic, select "File \ Export \ Netlist" from the main menu, select the netlist format, specify folder and file name, and press **OK** to save the netlist file.

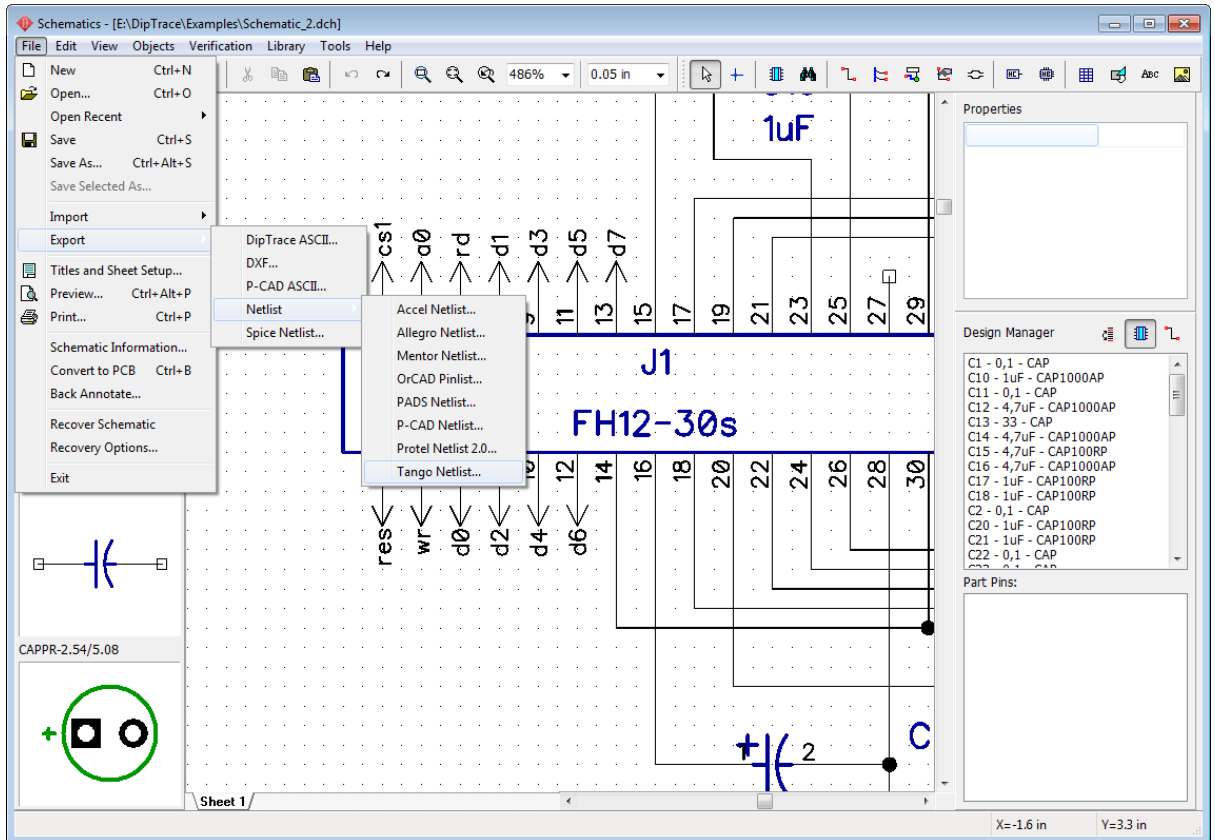

### Import netlist

DipTrace PCB Layout allows for importing netlists created in other software. We will import Tango netlist as an example. Launch the PCB Layout, create a new project, and select "File \ Import \ Netlist \ Tango" from the main menu, then select "tango\_1.net" file from "C:\Users\

As you already know, all components are represented by patterns on the circuit board. The first step while importing the netlist is to **make sure that each component has its pattern**. Check all patterns in the **File Components** list:

RefDes column shows component RefDes in the netlist,

Name column shows component's name,

Pattern Name column shows pattern's name from the netlist,

Pattern column shows attached pattern in the DipTrace libraries. If it is blank, the component does not have a pattern.

Press **Add** button to add new pattern libraries, where we will get the patterns that we need. For example, add CAP\_SMD library to find a pattern for C 225 components. Add several libraries at a time with "Shift" and "Ctrl" hotkeys. DipTrace standard libraries are in the "C:\Program Files\DipTrace\Lib" folder and user libraries – in the "Documents/DipTrace/My Libraries" folder by default.

Select library, and press **Assign all Patterns by Names** – the software will find and assign patterns with the corresponding names automatically. In our case, DipTrace has assigned the DO-41 patterns.

Sometimes DipTrace is not able to find all the patterns, because of partially or completely different pattern names in the DipTrace libraries and in the netlist. In this case, the designer should find and assign all patterns manually. Select a component in the **File Components** list, then select a library and pattern from the respective lists. Now press **Attach to Component** button to attach pattern to the component according to the component's RefDes, name, or pattern name. For example, we have attached the CAP\_2225 pattern to all components with CAP 225 pattern.

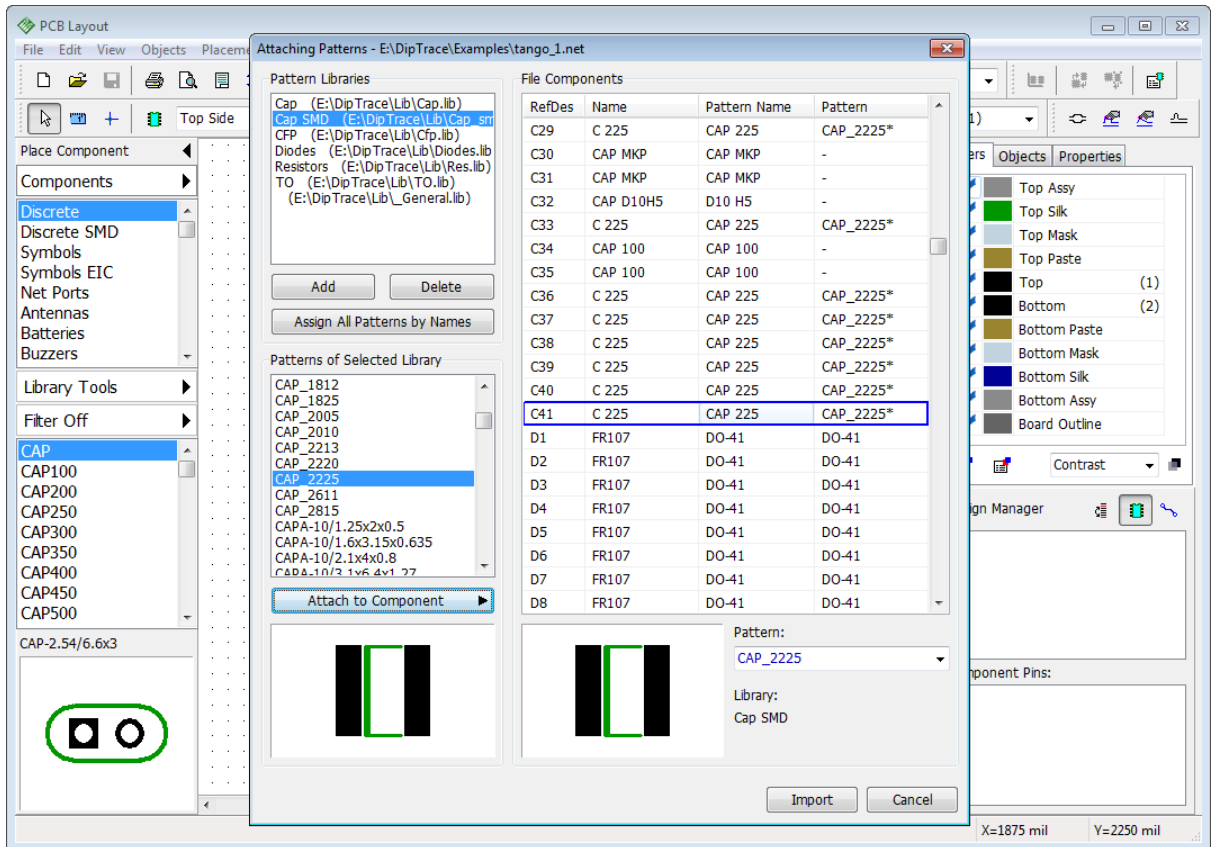

The star symbol (\*) after the pattern name in the list means that this pattern was connected manually.

Click **Import** button when all components have correct patterns.

## 5.17 3D preview and export

DipTrace PCB Layout module features built-in real-time 3D visualization with STEP and VRML export. This tool allows the user to visually check the circuit board with all components installed and export the PCB model to mechanical CAD programs for developing the device housing etc.

**Download and install 3D model libraries** from the DipTrace [website](#). Components without 3D models appear only as footprints on the circuit board in the 3D mode.

Launch PCB Layout then go to "File \ Open" (or press *Ctrl+O*) and select "C:

\Users\\Documents\DipTrace\Examples\PCB\_6.dip", then press  button on the Standard toolbar. The **Attached 3D Models** dialog box will pop up. DipTrace checks if all components have 3D models and tries to find correct models for components without them.



See 3D preview and export section in the PCB Layout Help ("Help \ PCB Layout Help" from the main menu) for more details.

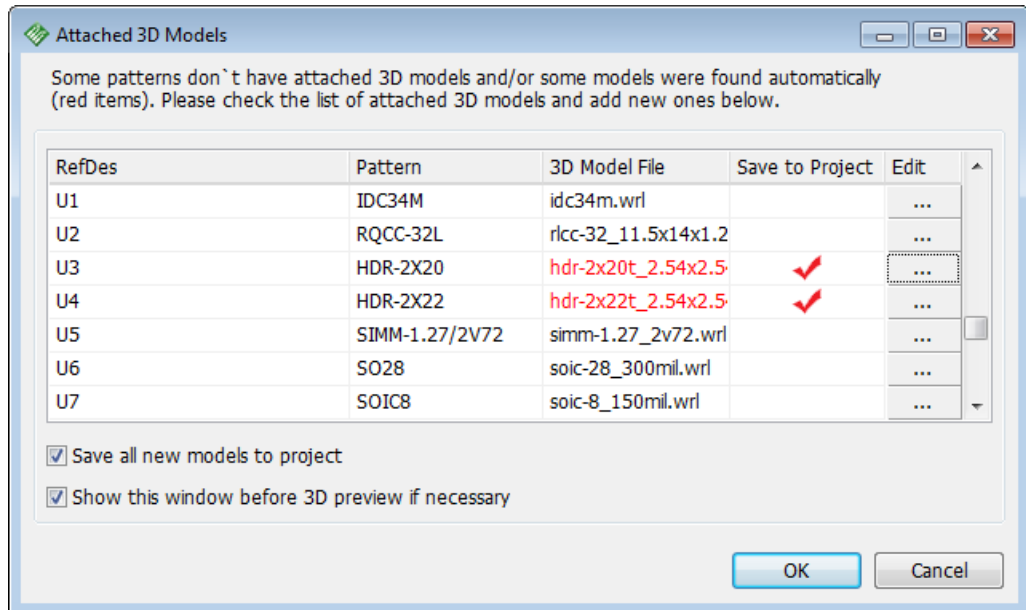

Press **OK**, and you'll see a 3D model of the circuit board. You can rotate the circuit board model by three axes, move it with your mouse, zoom in and out with the mouse wheel, etc.

You can change colors of the background, board, solder mask, and component and via display options, just press **Redraw** to implement certain changes.

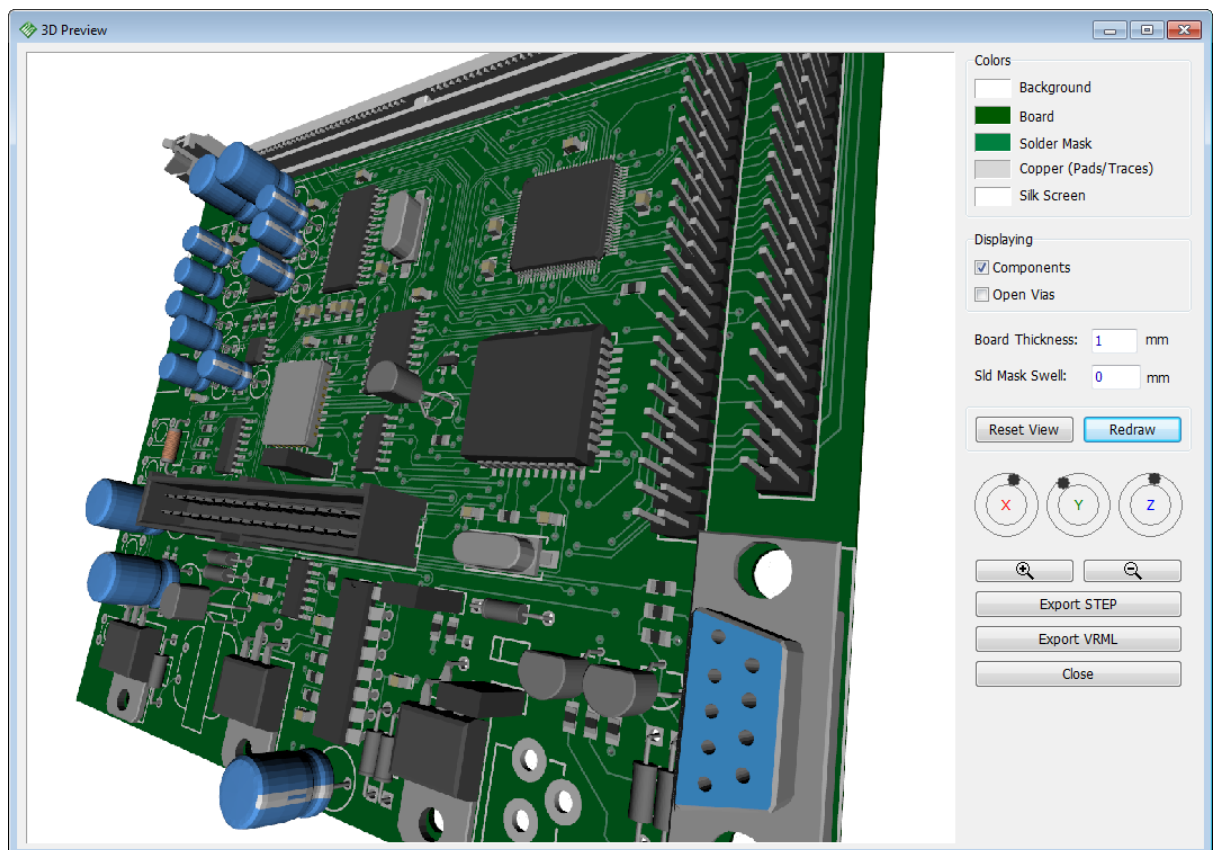

### 3D export

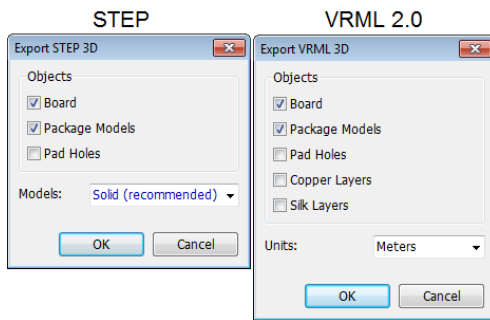

DipTrace 3D Preview module allows the user to export 3D model of the board to STEP (\*.step) and VRML 2.0 formats (\*.wrl) supported by most mechanical CAD software.

When in the **DipTrace 3D preview & export module**, press **Export STEP**. In the pop-up dialog box, specify which objects to include in the exported model (Board, Package models, Pad holes), and whether to export the model as a solid body or as parts.

Press **OK** to specify a filename and folder. We recommend exporting a project as a Solid body in STEP format.

*Notice that exporting holes dramatically slows the process.*

To export the board model to VRML format, press **Export VRML** button, select which objects to include in the exported model, set the units, press **OK**, and set the file location.

### Mapping a 3D model

Press  button in the **Attached 3D Models** dialog box or right-click on any component on the design area in the PCB Layout, and select **3D Model** from the submenu. In the pop-up dialog box, you can rotate a 3D model by three axes, zoom in and out, move the model by holding the right mouse button, and change colors of the preview.

If you need to change a 3D model, press **All Models>>** button, and select a 3D model from the list of all available models sorted by pattern libraries.

To attach a 3D model from the separate file, press the  button to specify the path to the file on your computer. DipTrace supports 3DS, VRML, STEP, and IGES files.

DipTrace automatically places a 3D model to fit the pattern's drawing, but sometimes you may need to adjust a 3D model location or its scale. Just enter appropriate values into the corresponding fields of the **3D Model Properties** section (shift, angle, and scale for each axis). Changes apply instantly. Check out [Attaching a 3D model topic](#)<sup>[105]</sup> of this tutorial and PCB Layout Help for more details about mapping a 3D model.

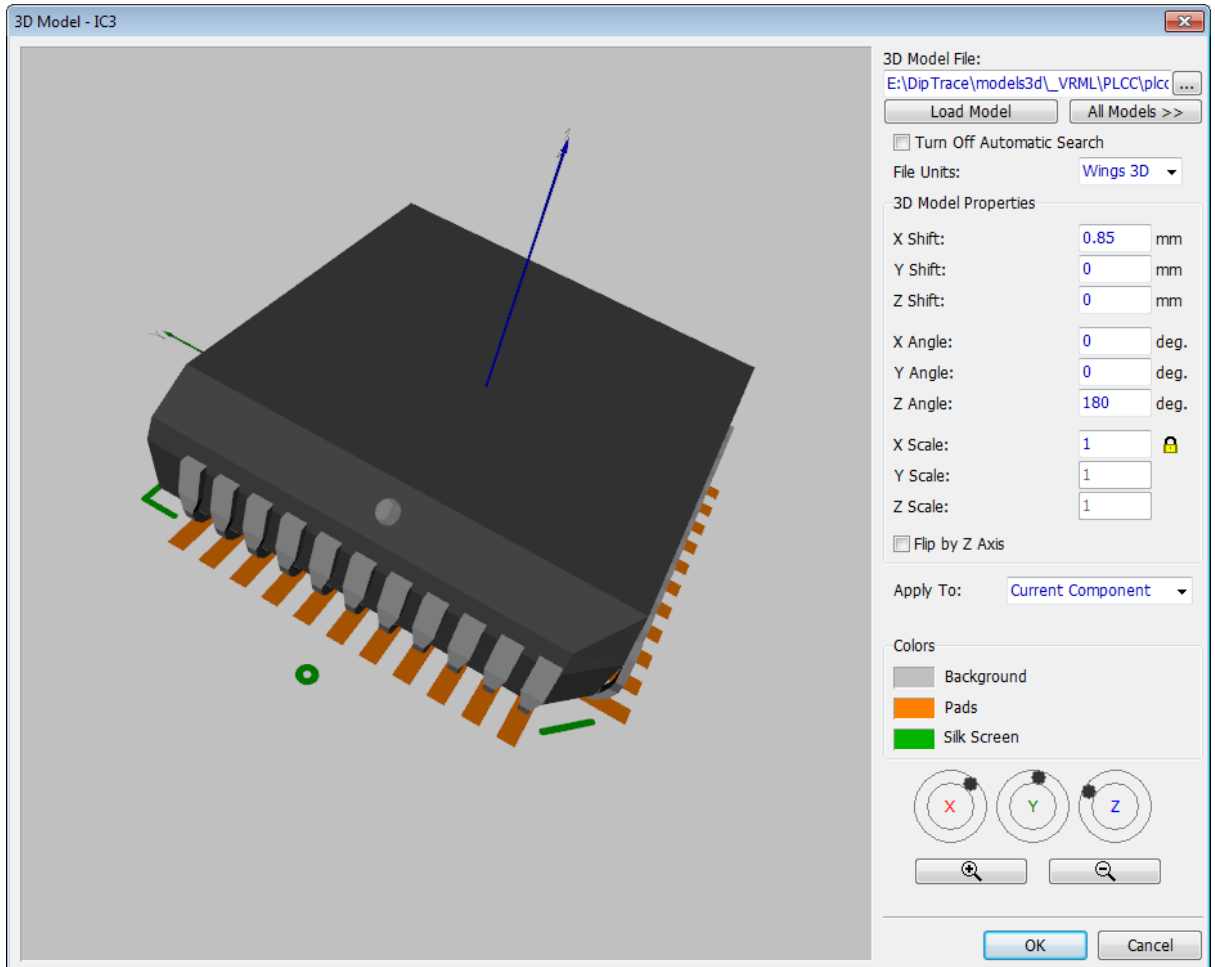

Press **OK** to close the **3D Model** dialog box.

### Search 3D models

Go to "Tools \ 3D Preview \ Patterns and Models Search", in the pop-up dialog box you can change the search accuracy and active search folders.

In the **Pattern Search** section, you can select the level of conformity that will be used by DipTrace while searching for the models (more strict requirements mean less possible models found). Press **Search 3D Models...** to check the results.

If you have 3D models in other folders on your machine, you need to let the software know that it should search 3D models in those folders, just add a new folder to the **3D Model Folders** list. By default, all 3D models are in the "models3d" folder inside the "DipTrace" directory.

*Notice that standard 3D libraries are not included in the DipTrace installation package. You need to download them from the [DipTrace website](#).*

*Notice that we recommend attaching 3D Models in the Pattern Editor while drawing footprints.*

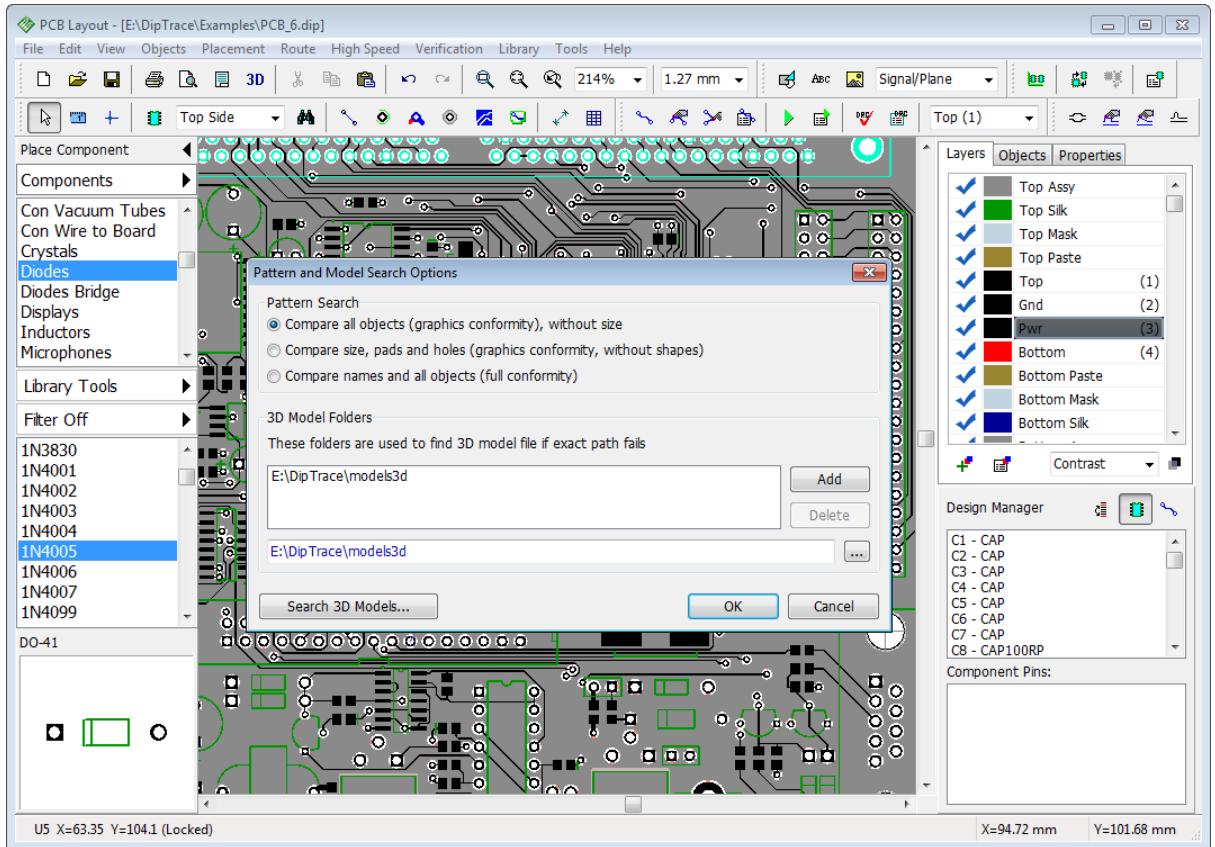

## 5.18 DipTrace Links

[DipTrace official website.](#)

[FAQ.](#)

[How to install DipTrace.](#)

[DipTrace Support Portal.](#)

[DipTrace Sales.](#)

[Download the latest version](#) (go to "Help \ About" if you don't know your current version).

[Order DipTrace.](#)

[Download Libraries.](#)

[DipTrace Forum](#) – suggest new features, discuss DipTrace and share your experience.

[DipTrace Community at Yahoo!](#)

[DipTrace PCB Design Service.](#)